



## **StoVentec Panel Facades** Application guideline

It should be noted that the following details, illustrations, general technical information, and drawings contained in this brochure are only general proposals and details which merely describe the basic functions schematically. No precise dimensions are included. The applicator/client is independently responsible for determining the suitability and completeness for the product in question. Neighbouring works are described only schematically. All specifications and information must be adjusted or agreed in the light of local conditions and do not constitute work, detail or installation plans. The technical specifications and product information in the Technical Data Sheets and in system descriptions/certificates must be observed.

# Contents



## System information

<b>System description</b>	<b>4</b>
<b>System cross-sections</b>	<b>6</b>
<b>Installation requirements</b>	<b>6</b>
<b>Working drawings</b>	<b>7</b>



## Application of the system

<b>Sub-construction/insulation</b>	<b>8</b>
Measuring the facade	8
Installation - wall brackets	10
Installation - insulation	11
Installation - vertical carrier profiles	12
Installation - agraffe profiles	13
<b>Panel</b>	<b>15</b>
Preliminary work (applies only to StoVentec Stone Massive)	15
Installation - panel	15



## Details

<b>Plinth</b>	<b>17</b>
Plinth formation	17
Installation - starter track	17
Installation - ventilation profiles	18
<b>Corner formation</b>	<b>18</b>
External corner	18
Internal corner	19
<b>Connections</b>	<b>19</b>
Parapet	19
Connection - window sill	20
Reveal formation	20
Lintel formation	21
Lintel formation with solar protection	21
<b>Fire barrier</b>	<b>22</b>
Horizontal fire barrier	22
<b>Ceiling cladding</b>	<b>22</b>
Ceiling cladding with StoVentec Glass	22
Connection ceiling/upward-oriented facade with open joint	23

## System description

### StoVentec Glass

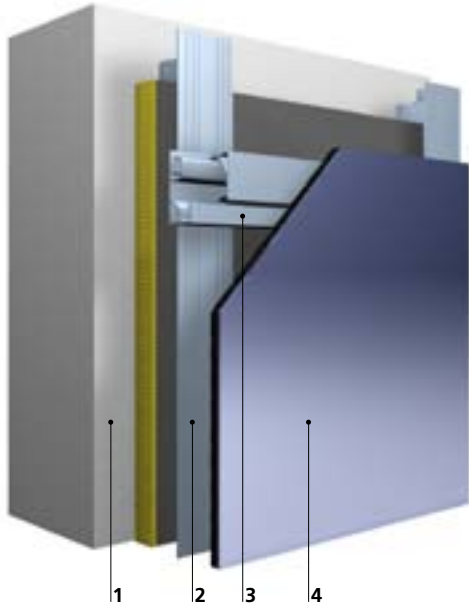

#### 1 Insulation:

Sto-Mineral Fibre Board 033 RSC/035 RSC Fix  
 Insulation board made of mineral wool, non-combustible, fire class A1 in accordance with EN 13501-1, black fleece lamination on one side, melting point > 1,000°C, thermal conductivity group 033 or 035  
 Alternatively: Sto-Glass Wool Board 032 RSC Fix, thermal conductivity group 032  
 Note: It is possible to use the one-dowel-technique for Sto-Mineral Fibre Board 035 RSC Fix and Sto-Glass Wool Board 032 RSC Fix subject to project-related approval by the insulant supplier.

#### 2 Vertical sub-construction:

Sto-Stainless Steel Wall Bracket and Sto-Aluminium T-Profile  
 Sub-construction made of stainless steel wall brackets and aluminium T-profiles. Stainless steel wall brackets with minimised thermal bridging, optimised installation, maximum functional precision.

#### 3 Horizontal agraffe profiles:

StoVentec Aluminium Agraffe Profile  
 Agraffe profile for easy positioning and mounting of the panel, high "resistance to torsional stiffness"

#### 4 Cladding:

StoVentec Glass Panel  
 Factory-produced glass panel for mounting, concealed fixing spots, available in different RAL colour shades as well as with individual screen printing.

### StoVentec Glass

#### Ventilated rainscreen cladding system with glass panels

<b>Area of application</b>	<ul style="list-style-type: none"> <li>Existing and new buildings subject to fire protection regulations</li> <li>Onto all load-bearing anchorage substrates</li> </ul>
<b>Properties</b>	<ul style="list-style-type: none"> <li>System weight: approx. 30 kg/m<sup>2</sup></li> <li>Levels unevenness by means of an adjustable stainless steel/aluminium sub-construction</li> <li>Improved sound insulation by up to 10 dB</li> <li>Full-surface bonding prevents dropping of the system in case of glass breakage caused by mechanical damage</li> <li>Low thermal bridge coefficient thanks to stainless steel wall brackets</li> <li>Optimal building physics through back-ventilation</li> <li>Highly weather-resistant</li> <li>Limited combustibility</li> <li>Building inspectorate approved as facade cladding and ceiling underside</li> <li>Subsequent element replacement (in case of damage)</li> </ul>
<b>Appearance</b>	<ul style="list-style-type: none"> <li>Glass surface</li> <li>Concealed fixing</li> <li>Resistant, smooth surface ensuring low maintenance costs for cleaning</li> <li>Gloss surface with depth effect</li> <li>Wide colour variety (RAL colour shades, individual screen printing, etc.), no limitations to the lightness value</li> <li>Panels can be delivered in customised formats for any type of joint pattern</li> <li>Bevelling of the carrier board edges where required</li> <li>Glass projection towards carrier board edge is approval-compliant up to 4 cm</li> <li>Maximum panel format: 1.25 x 2.6 m (larger formats can be realised in individual cases, subject to approval)</li> </ul>
<b>Application</b>	<ul style="list-style-type: none"> <li>Fitting of factory-produced panels in the sub-construction at the construction site</li> <li>Installation possible in all weathers</li> <li>Fast installation</li> <li>Complete detail solutions</li> </ul>
<b>Approvals</b>	<ul style="list-style-type: none"> <li>The relevant European and/or national approvals apply.</li> </ul>

#### Important notes

- The panels cannot be subsequently modified. Precise measuring including the joint pattern is therefore imperative.
- For types with glass projection, markings from the glass projection as a result of unfavourable light conditions and certain colour shades cannot be excluded.
- Before panel production is started, the planner/building owner or applicator is required to approve the colour shade (by means of a colour sample) and the panel production drawings. Minor colour deviations are due to technical reasons.
- Tempered safety glass is used for StoVentec Glass Panels. Alternatively and upon request of the customer, tempered safety glass subject to a heat-soak test (ESG-H) can be used.
- For some colour shades (e.g. white, yellow and red shades), glass which is low in iron oxide (white glass) may be required. This can be realised at the request of the customer.
- Customised panes and bevel cuts as well as required openings and recesses have to be discussed with the system supplier beforehand. Observe the technically required minimum radii.

## System description

### StoVentec Stone Massive



#### 1 Insulation:

Sto-Mineral Fibre Board 033 RSC/035 RSC Fix  
 Insulation board made of mineral wool, non-combustible, fire class A1 in accordance with EN 13501-1, black fleece lamination on one side, melting point > 1,000°C, thermal conductivity group 033 or 035  
 Alternatively: Sto-Glass Wool Board 032 RSC Fix, thermal conductivity group 032  
 Note: It is possible to use the one-dowel-technique for Sto-Mineral Fibre Board 035 RSC Fix and Sto-Glass Wool Board 032 RSC Fix subject to project-related approval by the insulant supplier.

#### 2 Vertical sub-construction:

Sto-Stainless Steel Wall Bracket and Sto-Aluminium T-Profile  
 Sub-construction made of stainless steel wall brackets and aluminium T-profiles  
 Stainless steel wall brackets with minimised thermal bridging, optimised installation, maximum functional precision

#### 3 Horizontal agraffe profiles:

StoVentec Aluminium Agraffe Profile  
 Agraffe profile for easy panel positioning and mounting, high "resistance to torsional stiffness"

#### 4 Cladding:

StoVentec Stone Massive Panel  
 Factory-produced natural stone panel with undercut anchor, concealed fixing, available in various types of stone: honed, polished, sand-blasted as well as sand-blasted and brushed

### StoVentec Stone Massive ventilated rainscreen cladding system with natural stone panels

<b>Area of application</b>	<ul style="list-style-type: none"> <li>Existing and new buildings</li> <li>Onto all load-bearing anchorage substrates</li> </ul>
<b>Properties</b>	<ul style="list-style-type: none"> <li>System weight: up to more than 100 kg/m<sup>2</sup> depending on the type and thickness of the natural stone</li> <li>Levels unevenness by means of an adjustable stainless steel/aluminium sub-construction</li> <li>Improved sound insulation by up to 10 dB</li> <li>Low thermal bridge coefficient thanks to stainless steel wall brackets</li> <li>Optimal building physics through back-ventilation</li> <li>Non-combustible</li> <li>Can be used as facade and ceiling cladding</li> <li>Subsequent element replacement (e.g. in case of damage)</li> </ul>
<b>Appearance</b>	<ul style="list-style-type: none"> <li>Solid natural stones such as Kirchheim shell limestone, sandstone, dolomite, etc.</li> <li>Available surface treatment: honed, polished, sand-blasted as well as sand-blasted and brushed</li> <li>Fixing with concealed undercut anchors</li> </ul>
<b>Application</b>	<ul style="list-style-type: none"> <li>Fitting of factory-produced panels in the sub-construction at the construction site</li> <li>Installation possible in all weathers</li> <li>Fast installation</li> <li>Complete detail solutions</li> </ul>
<b>Approvals</b>	<ul style="list-style-type: none"> <li>The relevant European and/or national approvals apply.</li> </ul>

#### Important notes

- Subsequent modification of the panels by the customer is only possible to a very limited extent and in close coordination with the system supplier. Precise measuring including the joint pattern is therefore imperative.
- Before panel production is started, the system supplier must be notified by the planner/building owner or applicator about the release of the stone including the desired surface treatment (by means of an original sample) and the panel drawings.
- Minor deviations in colour and texture are due to product characteristics.
- Bevel cuts as well as required openings and recesses have to be discussed with the system supplier beforehand. Observe the technically required minimum radii.
- The building owner/planner has to specify the treatment of visible panel edges and discuss its feasibility with the system supplier.

## System sections

## Installation requirements

### Vertical projection

#### StoVentec Glass/StoVentec Stone Massive

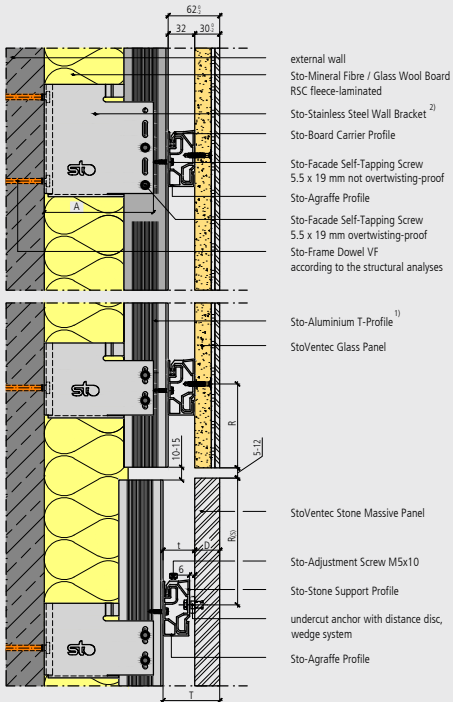

A	= projection of wall bracket (see EAG 004)
D	= thickness of stone slab in accordance with material and structural analyses
R	= distance to edge in accordance with approval Z-33.2-658
R <sub>50</sub>	= edge spacing of undercut anchor in accordance with structural analyses
T	= overall structure, natural stone element of front edge of T-profile
t	= structure depth, rear side, stone to leading edge T-profile (36 mm system wedge)

1) Align profile joints with position of horizontal panel joints.

2) Arrangement of fixed and sliding point brackets in accordance with structural analysis / factory planning

### Horizontal projection

#### StoVentec Glass/StoVentec Stone Massive

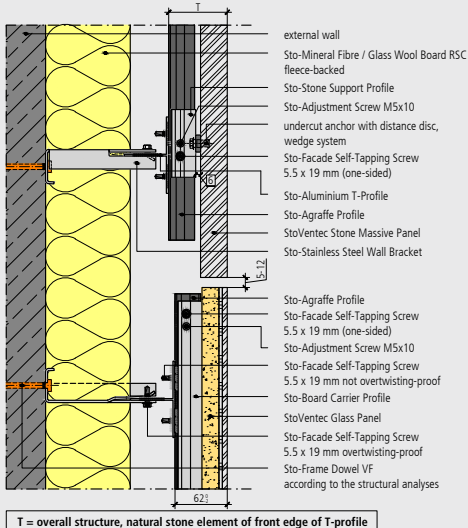

- If the substrate is load-bearing and able to bear the load of the facade and/or ceiling cladding, a suspended, ventilated rainscreen cladding system can be properly installed based on a project-related wind load calculation as well as a project-related structural analysis. The system is ideal for problematic substrates. Even large unevenness in the anchorage substrate can be compensated for.
- Doors, windows, roller shutter boxes, parapets, horizontal surface caps and window sills must be installed before the facade or ceiling cladding. The planned system structure must be taken into account when determining an adequate projection of parapets and horizontal surface caps as well as window sills.
- The building shell tolerance must be determined and the required wall bracket projections specified as compared to the initial planning.
- As part of his working drawings and before installation of the complete system, the applicator must specify and coordinate the required formation of details and system connections. Besides the project-related structural analyses and, where required, the system approval, it is the project-related conditions that must be considered in particular
- When it comes to structural analyses and/or the preparation of layout plans, we would be happy get you in contact with experienced service providers. As a preparatory measure and depending on the anchorage substrate, it may be necessary to perform project-related dowel extraction tests. Also for these tasks, we can get you in contact with competent partners.

# Working drawings

## Step 1: Specification/installation - wall bracket and T-profile

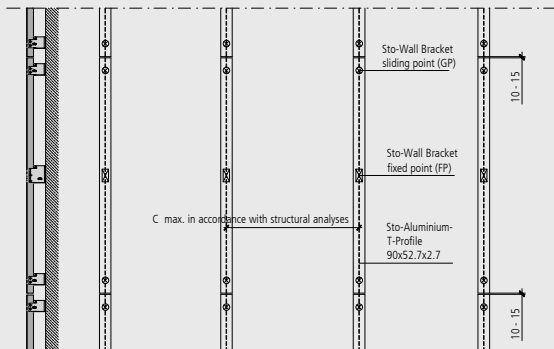

## Step 2: Specification/installation - agraffe profile

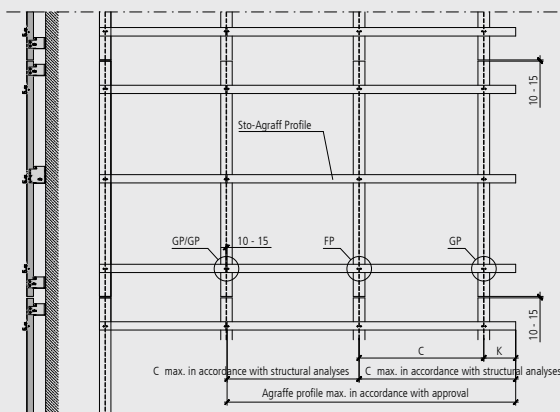

## Step 3: Installation - StoVentec Glass Panel

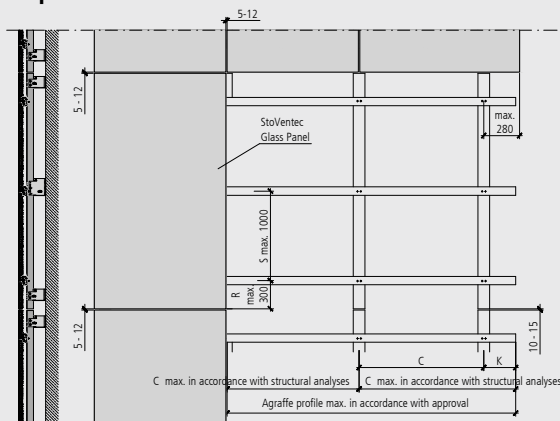

C = span width agraffe profile in accordance with approval Z-32.2-658 / Structural analyses / Working drawings  
 K = collar arm agraffe profile in accordance with approval Z-32.2-658 / Structural analyses / Working drawings  
 $K \leq C$ ;  $K \leq 250$  mm  
 R = distance to edge in accordance with approval Z-32.2-658  
 S = axis spacing Agraffe Profile in accordance with approval Z-32.2-658 / Structural analyses / Working drawings  
 Rod diagram T- and agraffe profile in accordance with approval Z-32.2-658 / Structural analyses / Working drawings  
 Design of fixed and sliding points, see EAG 017 and 018

## Important notes

- Measuring carried out at the object lies in the applicator's area of responsibility and serves as basis for structural analyses, working drawings and panel ordering
- The T-profile and agraffe profile joints (horizontal and vertical) must be matched to the panel joints.
- Where required, take fire barriers into account
- The current system drawings [EAG010](#), [EAG011](#), [EAG014](#), [EAG015](#), [EAG016](#) must be observed during planning.
- Determine the existing building shell tolerances for the entire facade surface at the marked profile axes using a reference line or laser. The required wall bracket projections must be specified.
- Observe the arrangement of the building expansion joints. Where required, additional profile axes must be provided.
- The wall brackets should project at least 2 cm from the insulation to allow optimum screw fixing.
- To determine the ideal wall bracket length, reduce the spacing between the bare wall and the front edge of the finished facade by the following:
  - approx. 80 mm in case of StoVentec Glass
  - approx. 55 mm plus stone thickness in case of StoVentec Stone Massive

## Sub-construction / insulation

### Measuring the facade

#### 1) Determining the base point

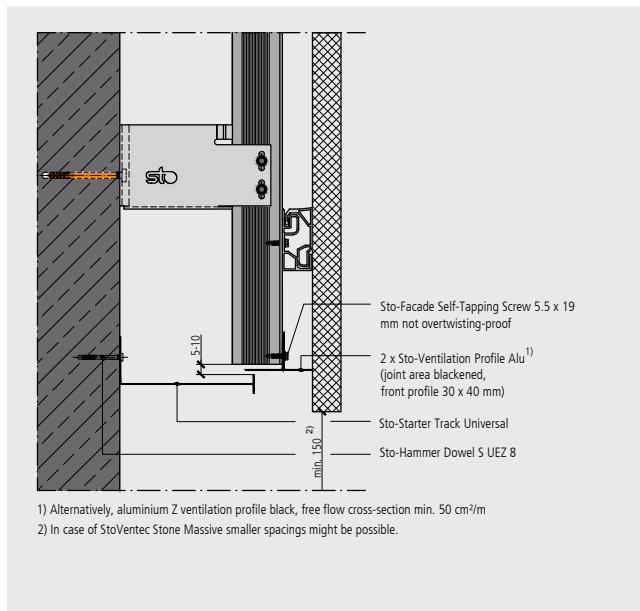

#### 2) Marking the vertical profile axes



Mark the vertical profile axes according to the project-based structural analyses and working drawings while taking into account the planned joint pattern of the facade.



Centre line of the vertical profile axes

### Note

The base point of the facade is to be set above ground level, balconies, patios, roof surfaces, etc. in a way which ensures continuous system ventilation and prevents the facade cladding from constant soaking due to spray water from neighbouring horizontal surfaces. The given reference points must be taken into account when specifying the relative elevations.



## Sub-construction / insulation

### 3) Arranging the wall brackets



The arrangement of the wall brackets as fixed and sliding points in accordance with the project-based structural analysis and the working drawings must be determined on the already marked exterior profile axes.



The arrangement of the wall brackets is transferred to the centre line using a chalked string.



Mark the position of the fixed point wall brackets according to the project-related structural analyses and working drawings.



Mark the position of the sliding point wall brackets according to the project-related structural analyses and working drawings.



The offset of the profile to the dowel axis of approx. 20 mm must be observed. Important: The wall bracket can be installed on the left or right as required.

### Installation - wall brackets



#### Product tip

##### Sto-Stainless Steel Wall Bracket

- Minimisation of thermal bridges
- 20 mm increments
- 50 to 300 mm projection with a material thickness of 1.5 mm or according to the structural analyses
- 300 to 600 mm projections with a material thickness of 2.5 mm or according to the structural analyses
- Can be used horizontally, e.g. for fire barriers
- Installation as wall and ceiling bracket (in combination with pendulum rods for large suspension heights)
- Available as fixed and sliding point wall brackets
- Integrated clamping spring



#### Product tip

##### Sto-Facade Screw Dowel

- Suitable for almost all solid anchorage substrates
- Highly resistant to structural loads
- Application according to the structural analyses



1

For installation of the wall brackets, the drill holes must be made by impact or turning, depending on the anchorage substrate and dowels and in accordance with the dowel approval. The specified minimum hole depth must be observed. The drill hole must be blown out in accordance with the specifications in the dowel approval.



2

Insert the wall brackets into the drill hole in pass-through installation, if necessary backed with thermal stop elements, as fixed or sliding point with facade screw dowels (dowel collars), taking into account the required tolerance compensation with the corresponding projection in accordance with structural specifications.



3

The wall brackets must be oriented plumb.



4

The dowel screws are tightened so that full surface of the dowel collar rests on the wall bracket and the screw head on the dowel collar. Galvanised screw heads must be painted or levelled out at the connection to the dowel collar with a flexible, permanently elastic bitumen-oil combination coating, depending on the dowel approval.

#### Notes

##### Sto-Facade Screw Dowels for Sto-Stainless Steel Wall Brackets

- When setting the facade screw dowels, the specifications of the dowel approval must be observed.
- Use the facade screw dowels according to the anchorage substrate and in accordance with the project-based structural analyses.

## Sub-construction / insulation

### Installation - insulation

#### Fixing diagram for insulation boards

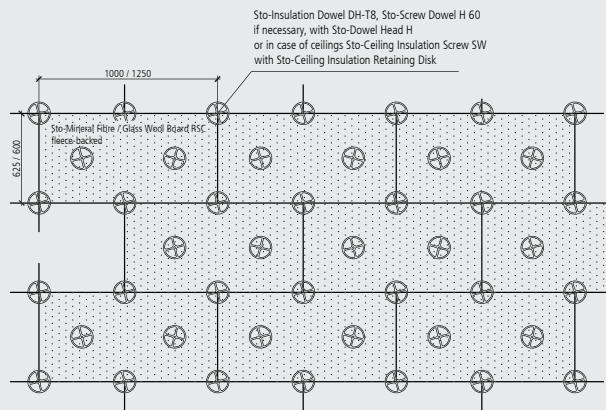

In case of rear ventilation gap  $h < 6$  cm (see EAG 001, 002 and 006) do not install insulation dowels in the carrier profile area.  
Consumption of insulation dowels, average of 5 pieces/m<sup>2</sup> in accordance with DIN 18516-1, in centre of panel 1 to 2 insulation dowels.

#### Tip

For insulants with the corresponding approval, the one-dowel technique can be used upon project-related coordination agreement with the insulation manufacturer. The specifications of the insulation and dowel supplier must be observed.

#### Information

##### Requirements to be met by the insulant

- Insulation board made of mineral or, alternatively, glass wool in accordance with EN 13162
- Insulant with external black fleece lamination
- Non-combustible A1 or A2 -s1,d0 according to EN 13501-1
- Insulant continuously water-repellent and permanently dimensionally stable

#### Important note

With a ventilation airspace of less than 6 cm, no insulation dowels can be set near vertical profile axes, since the gutters of the vertical carrier profiles go into the insulation level. In this case, the required insulation dowels must be installed next to the profile axes.



1  
Insulation is carried out before the vertical carrier profiles are installed. Place the insulation boards in a bond pattern without gaps, score and press them over the wall brackets.



2  
Secure the insulation boards against slipping with an average of 5 Sto-Insulation Dowels per m<sup>2</sup>. Back-ventilation of the insulation must be excluded. When setting the insulation dowels, the anchorage depth of at least 20 mm must be observed. The insulant must not be compressed. Installation-related gaps in the insulation must be stuffed with the original insulation material.

## Sub-construction / insulation

### Installation - vertical carrier profiles



#### Product tip

##### Sto-Aluminium-T-Profile

- Specified screw fixing area
- Grooved texture for easy positioning of the drilling screws in the profile gutter and flange

#### Tip

- For each facade and ceiling surface, align the first and last axis and install it to the wall brackets according to the structural analyses. Then install a horizontal reference line for orientation of the remaining profiles. Alternatively, use a laser.
- Set the profiles, starting from the external axes and moving towards the centre.
- If aluminium / stainless steel rivets are used as connectors, suitable riveters and rivet jigs must be used to ensure the T-profiles are installed without bending.

#### Versions

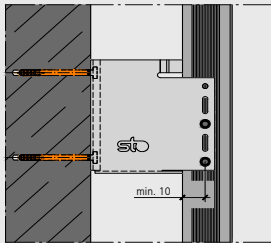

fixed point (FP)

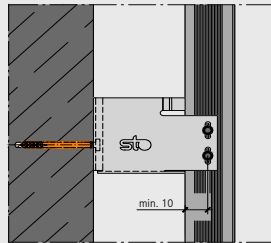

sliding point (GP)

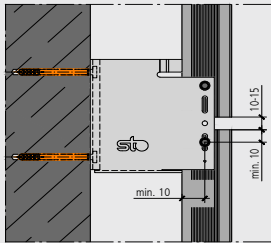

fixed / sliding point (FP/GP)

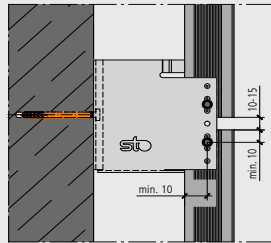

sliding / sliding point (GP/GP)



In case of a ventilation airspace of < 5 cm, score the insulant at the stem of the T-profiles. Cut the T-profiles using a mitre saw. Insert the T-profiles. Align the T-profiles to the reference line.

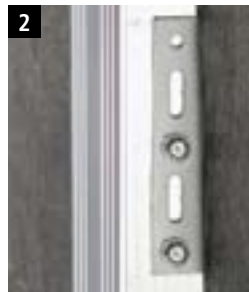

Screw on the T-profiles according to the structural analyses as fixed and sliding points with Sto-Self-Tapping Facade Screws 5.5 x 19 mm that cannot be over-tightened (alternatively, rivet with aluminium / stainless steel rivets according to structural analyses). For fixed points, screwing/riveting is carried out in the middle and lower round hole, subject to structural analyses.



For sliding points, screwing/riveting must be carried out centrally in the oblong holes of the wall brackets.



All profile joints must be formed with a joint width of at least 10 mm to cater for lengthwise thermally-induced expansion.

## Sub-construction / insulation

### Installation - agraffe profiles (tension-free)

#### Versions

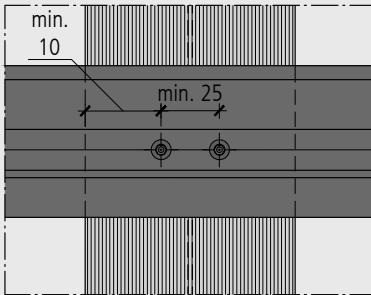

fixed point - Sto-Agraffe Profile

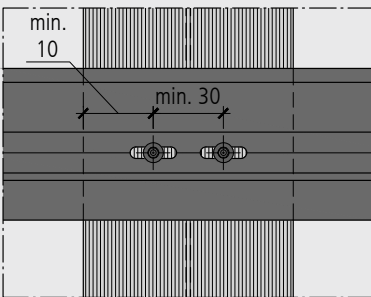

sliding point - Sto-Agraffe Profile

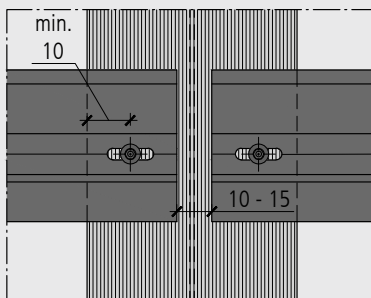

sliding / sliding point - Sto-Agraffe Profile

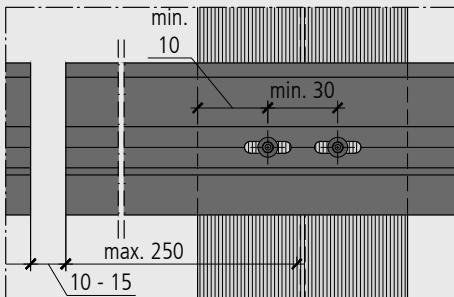

sliding / sliding point - Sto-Agraffe Profile with collar arm

### Installation - agraffe profiles (tension-free)

#### Oblong hole formation

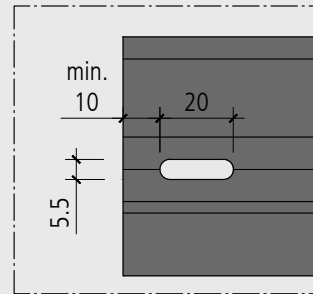

oblong hole detail

#### Important note

- Screw connections between the agraffe profile and the T-profile must be carried out using a StoVentec Self-Tapping Facade Screw 5.5 x 19 mm (without over-tightening protection) according to the structural analyses.

#### Positioning of agraffe profiles

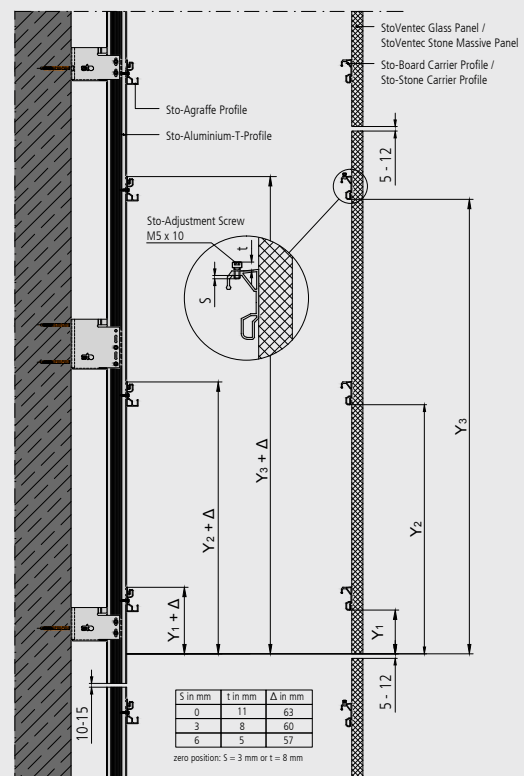

illustration without insulation

S = screw-in depth of Sto-Adjustment Screw

t = excess length of Sto-Adjustment Screw

Y = edge distance of board / stone carrier profile in accordance with production drawing

## Sub-construction / insulation

### Installation - agraffe profiles (tension-free)



Agraffe measuring and transfer to other profile axes using a spirit level and/or chalk line.



Blacken the sub-construction around the panel joints (e.g. using black spray paint or adhesive tape).



Install the agraffe profile (bar length in accordance with the installation requirements, maximum length must not be exceeded) without tension producing fixed and sliding points. Connect the T-profile to the agraffe using StoVentec Self-Tapping Facade Screws 5.5 x 19 mm (alternatively aluminium / stainless steel rivets can be used subject to the structural analyses).



In case of fixed points the agraffe profile can be pre-drilled on the marking line as required. Provide a fixed point with 2 screws/rivets for each agraffe profile.



At the sliding points, fasteners must be placed in the centre of the oblong holes (5.5 x 20 mm), which have to be produced on site.



Produce agraffe profile joints with a joint width of 10 to 15 mm to cater for lengthwise thermally-induced expansion.

# Panel

## Preliminary work (applies only to StoVentec Stone Massive)



1 Check and, where required, blow out the drill hole.



2 Insert the undercut anchor.



3 Apply a spacer disc.



4 Screw on the stone carrier profile in an adjustable and fixable manner (at the top) and align it.



5 Screw on the stone carrier profile rigidly (at the bottom) and align it.

## Installation - panel

### Adjustment range of adjustment screw

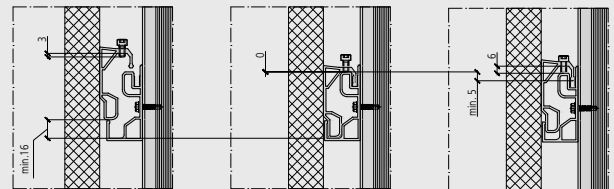

### Required mounting height

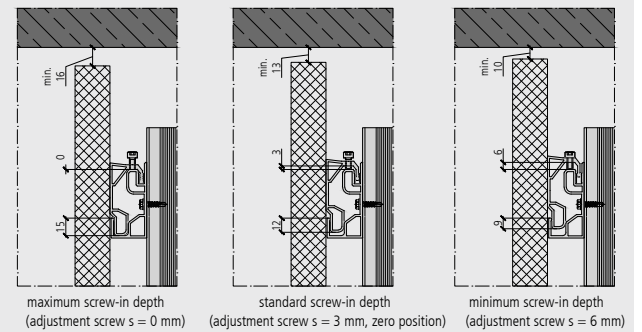

### Protection against lateral movement

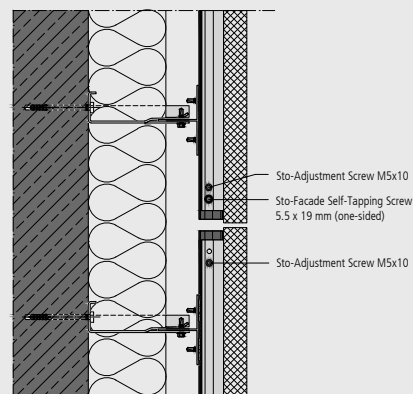

Only applicable to facade panels



### Note

If it is necessary to temporarily place the panels on the floor/rack during installation, make sure to place them on a soft surface. This is imperative to prevent damage, e.g. in the area of the edges.

# Panel



**1** Remove borings from the agraffe profiles to allow for trouble-free agraffe panel fitting.



**2** Drive the StoVentec Adjustment Screw (StoVentec Glass: M5 x 10 mm; StoVentec Stone Massive: M6 x 10 mm) into the top panel carrier profile (to zero position, screw-in depth set to 3 mm).



**3a** StoVentec Glass: use glass suction cups or a suction cup battery to mount the panel.



**3b** StoVentec Stone Massive: mount the panel either manually or using a belt.



**4** Align the panels vertically and horizontally. Ensure that a consistent joint pattern (min. joint width for StoVentec Glass is 5 mm, max. joint width 12 mm) is maintained.



**5** The panels are horizontally aligned by means of adjustment screws. During alignment, the panels should be slightly lifted to relieve the adjustment screws.



**6a** StoVentec Glass: tension-free panel fixing to the top panel carrier profile to prevent lateral movement, e.g. by using a unilateral plug connection or drilling screw.



**6b** StoVentec Stone Massive: tension-free panel fixing to a top panel carrier profile to prevent lateral movement, e.g. using a plug connection or drilling screw.

## Important note

Clean the panel surfaces when dismantling the auxiliary tools (StoVentec Glass: use a standard glass cleaner).



# Plinth

## Plinth formation

### Plinth connection

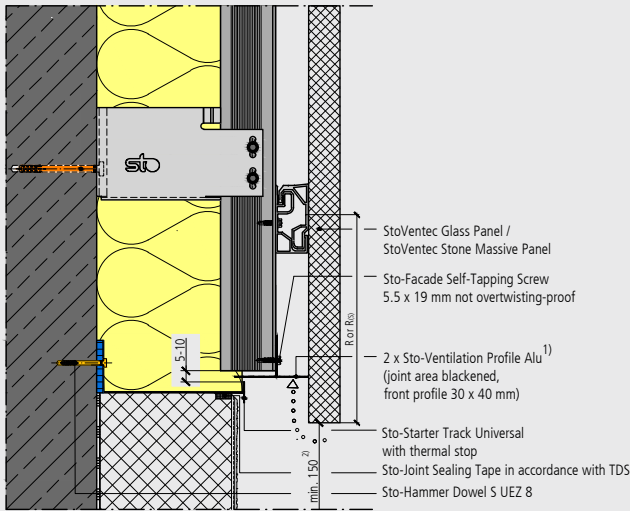

R or R(s) = distance to edge in accordance with approval Z-33.2-658 or structural analysis of stone

- 1) Alternatively, aluminium Z ventilation profile black, free flow cross-section min. 50 cm<sup>2</sup>/m
- 2) In case of StoVentec Stone Massive smaller spacings might be possible.

### Plinth connection - StoVentec Stone Massive for plinth heights < 150 mm

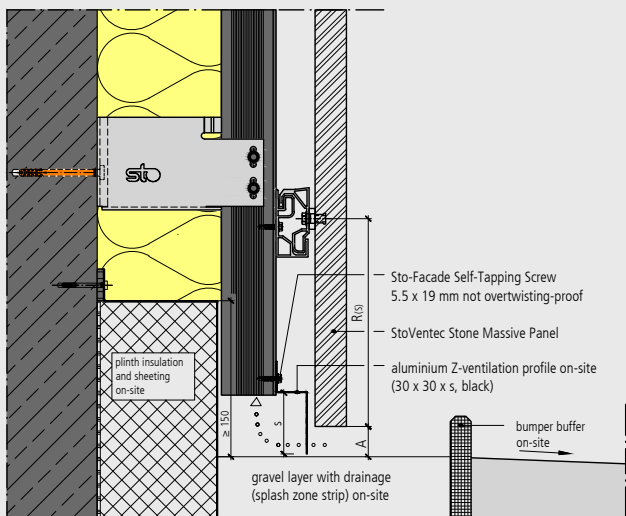

A = spacing in accordance with material  
R(s) = edge spacing of undercut anchor in accordance with structural analyses

## Installation - starter track



Before starting the installation work, the plinth height must be determined (see also page 8) and marked with a plumb line. The plinth and perimeter insulation has to be carried out according to the specifications and application guidelines of Sto AG.



The connection joint between the starter track and plinth insulation is sealed against driving rain with the Sto-Joint Sealing Tape.



The Sto-Starter Tracks Universal are mounted horizontally according to the insulation thickness and must rest neatly on the bare wall. Sto-Packing Shims and/or Sto-Thermocouples are used to compensate for unevenness in the wall. The starter tracks are fixed at intervals of approx. 33 cm with Sto-Hammer Dowels. Avoid twisting the tracks.



The starter tracks should be fixed to the exterior holes, if possible. Attach Sto-Starter Track Connectors to facilitate installation of the starter tracks.



Use the Sto-Starter Track Universal Corner Pieces at the building corners. The corner pieces can be adapted to the angle of the external corner.

## Plinth

### Installation - ventilation profiles



#### Product tip

**Sto-Ventilation Profile Alu**  
Profile for securing system ventilation and small animal protection in the plinth area and the lower end of the system (dimensions 30 x 40 mm and 40 x 100 mm)



1 A joint of 5 to 10 mm is formed between the starter track and the Sto-Aluminium T-Profile.



2 For the ventilation profile, the insulation at the upper edge of the starter track is scored as needed.



3 Insert the back ventilation profile into the insulation.



4 A second ventilation profile covers the area between the T-profile and the back of the panel. Screw both ventilation profiles to the T-profile flanges together. The horizontal profile flanges can be arranged at the same level. The complete ventilation airspace from the front edge of the insulation to the back of the panel must be covered. Alternatively, an edged Z-shaped ventilation profile may be installed.

## Corner formations

### External corner

#### External corner - StoVentec Glass

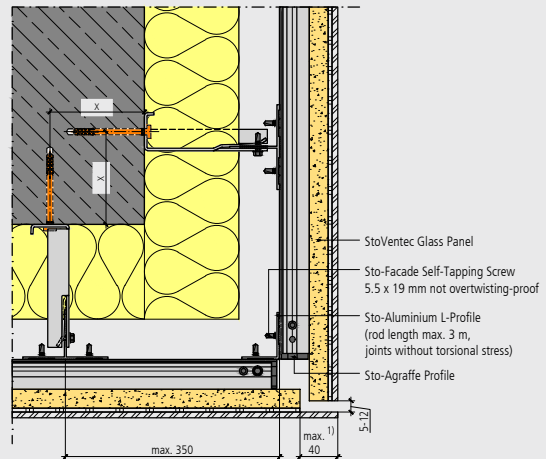

X = minimum edge distance in accordance with dowel approval

1) In case of unfavourable light conditions and certain colour shades, markings from the glass projection cannot be excluded.

#### External corner - StoVentec Stone Massive

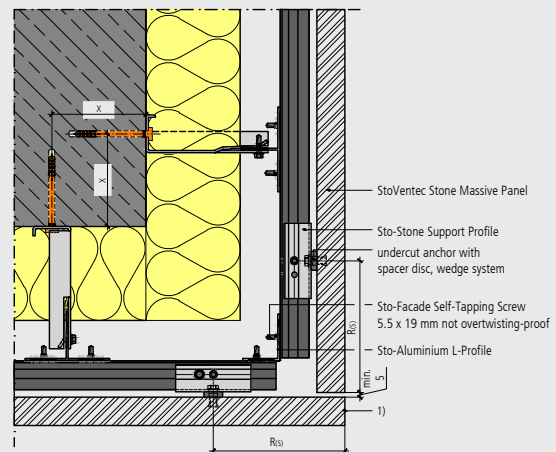

R(5) = edge spacing of undercut anchor in accordance with structural analyses

X = minimum edge distance in accordance with dowel approval

1) Working on front edge analogous to natural stone element surface in agreement with system supplier

#### Note

For system structures > 250 mm, special constructions may be required.

## Corner formations

### Internal corner

#### Internal corner StoVentec Glass

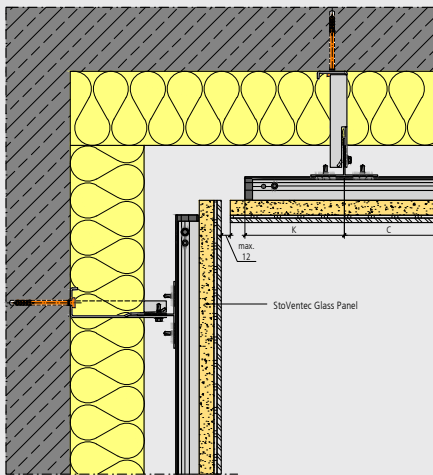

C = span width Sto-Agraffe Profile, see EAG 010 to 016  
K = collar arm Sto-Agraffe Profile, see EAG 010 to 016

## Connections

### Parapet

#### StoVentec Glass parapet ventilation with open joint

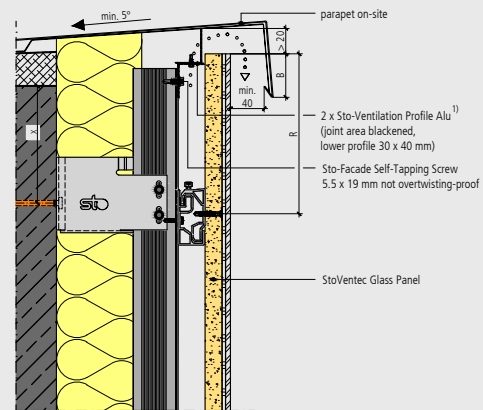

X = minimum edge distance in accordance with dowel approval  
R = distance to edge in accordance with approval Z-33.2-658

Building height	B	(in accordance with trade regulations for metalwork in the roofing trade)
< 8 m	min. 50 mm	
8-20 m	min. 80 mm	
> 20 m	min. 100 mm	

1) Alternatively, aluminium Z ventilation profile black, free flow cross-section min. 50 cm<sup>2</sup>/m

#### Internal corner - StoVentec Stone Massive

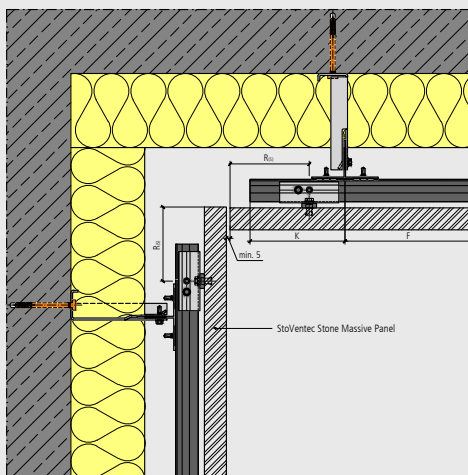

F = span width Sto-Agraffe Profile in accordance with structural analyses  
K = collar arm Sto-Agraffe Profile in accordance with structural analyses  
Re = edge spacing of undercut anchor in accordance with structural analyses

#### Parapet ventilation with open joint StoVentec Stone Massive

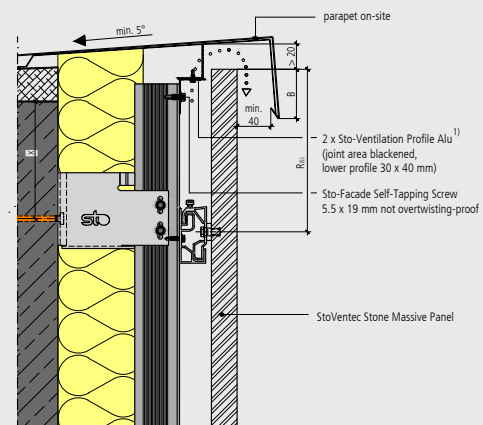

Re = edge spacing of undercut anchor in accordance with structural analyses  
X = minimum edge distance in accordance with dowel approval

Building height	B	(in accordance with trade regulations for metalwork in the roofing trade)
< 8 m	min. 50 mm	
8-20 m	min. 80 mm	
> 20 m	min. 100 mm	

1) Alternatively, aluminium Z ventilation profile black, free flow cross-section min. 50 cm<sup>2</sup>/m

#### Note

Indented corner panel should be 30 mm wider.

#### Notes

- In case of ventilation joints > 20 mm, two Sto-Ventilation Profiles Alu have to be installed in a Z-shaped arrangement (alternatively, Z-shaped ventilation profiles) to keep out small animals.
- Observe the required mounting height of the panels. See page 15.
- When the parapet cover is installed after the panels have been fitted, the upper end of the system must be temporarily covered.

# Connections

## Connection - window sill

## Reveal formation

### Ventilation window sill connection StoVentec Glass with open joint

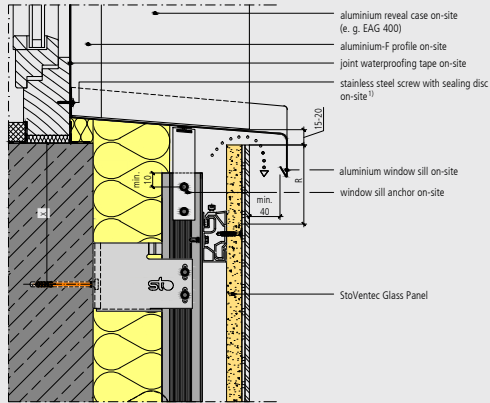

R = distance to edge in accordance with approval Z-33.2-658  
 X = minimum edge distance in accordance with dowel approval  
 wind-proofing, window waterproofing and fixing in accordance with RAL and/or window manufacturer's specifications.  
 Installation of window sill in accordance with installation directives defined in RAL directive RAL-GZ 695.

1) Clarify admissibility of screw connection of window sill to the window frame prior to installation.

### Lateral window connection StoVentec Glass with sheet-metal casing

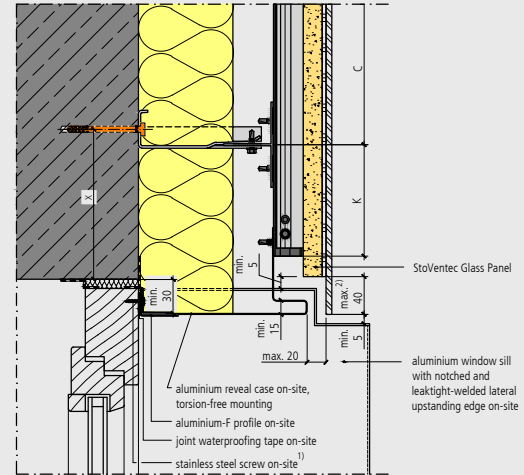

C = span width Sto-Agraffe Profile, see EAG 010 to 016  
 K = collar arm Sto-Agraffe Profile, see EAG 010 to 016  
 X = minimum edge distance in accordance with dowel approval  
 wind-proofing, window waterproofing and fixing in accordance with RAL and/or window manufacturer's specifications

1) Clarify admissibility of screw connection of F-Profile to the window frame prior to installation.  
 2) In case of unfavourable light conditions and certain colour shades, markings from the glass projection cannot be excluded

### Ventilation window sill connection StoVentec Stone Massive with open joint

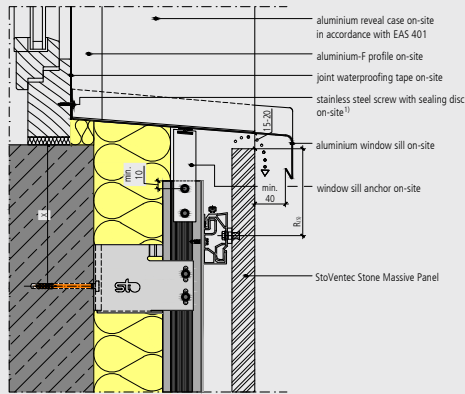

Re0 = edge spacing of undercut anchor in accordance with structural analyses  
 X = minimum edge distance in accordance with dowel approval  
 wind-proofing, window waterproofing and fixing in accordance with RAL and/or window manufacturer's specifications.  
 Installation of window sill in accordance with installation directives defined in RAL directive RAL-GZ 695.

1) Clarify admissibility of screw connection of window sill to the window frame prior to installation.

### Lateral window connection StoVentec Stone Massive with stone panel

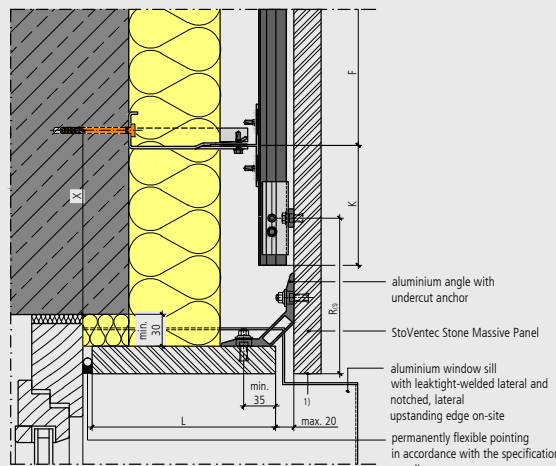

F = span width Sto-Agraffe Profile in accordance with structural analyses  
 K = collar arm Sto-Agraffe Profile in accordance with structural analyses  
 L = permissible projection of reveal element in accordance with structural analyses  
 Re0 = edge spacing of undercut anchor in accordance with structural analyses  
 X = minimum edge distance in accordance with dowel approval  
 wind-proofing, window waterproofing and fixing in accordance with RAL and/or window manufacturer's specifications.

1) Working on front edge analogous to natural stone element surface in agreement with system supplier

## Notes

- When determining the window connections, the building tolerances must be considered.
- In case of ventilation joints > 20 mm, two Sto-Ventilation Profiles Alu have to be installed in a Z-shaped arrangement (alternatively, Z-shaped ventilation profiles) to keep out small animals.
- For correct waterproofing and installation of the windows and doors, the specifications according to RAL must be observed.
- Observe the required mounting height of the panels. See page 15.
- Wind-proofing and fixing of the windows in accordance with RAL and/or manufacturer's specifications

# Connections

## Lintel formation

### Lintel ventilation StoVentec Glass with sheet-metal casing and open joint

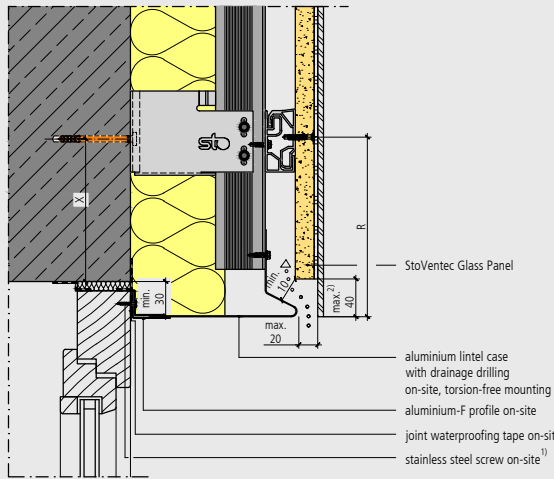

R = distance to edge in accordance with approval Z-33.2-659  
 X = minimum edge distance in accordance with dowel approval  
 wind-proofing, window waterproofing and fixing in accordance with RAL and/or window manufacturer's specifications.

- 1) Clarify admissibility of screw connection of F-Profile to the window frame prior to installation.
- 2) In case of unfavourable light conditions and certain colour shades, markings from the glass projection cannot be excluded.

## Lintel formation with solar protection

### Lintel ventilation StoVentec Glass with L-profile and open joint

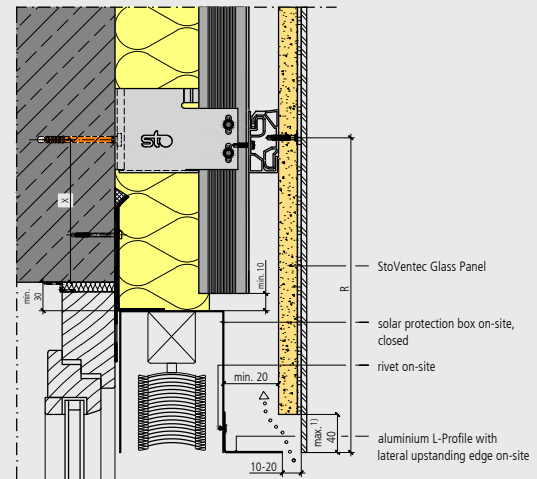

R = distance to edge in accordance with approval Z-33.2-659  
 X = minimum edge distance in accordance with dowel approval  
 wind-proofing, window waterproofing and fixing in accordance with RAL and/or window manufacturer's specifications.

- 1) In case of unfavourable light conditions and certain colour shades, markings from the glass projection cannot be excluded.

### Lintel ventilation StoVentec Stone Massive with stone panel and open joint

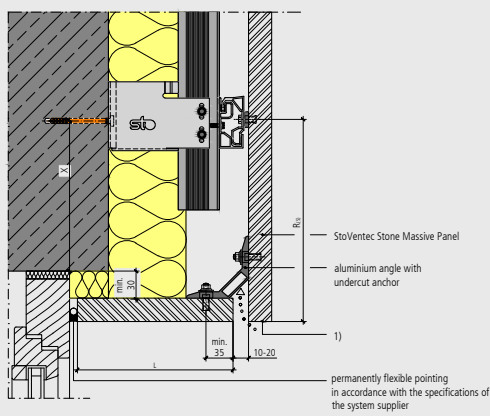

L = permissible projection of reveal element in accordance with structural analyses  
 R<sub>0.5</sub> = edge spacing of undercut anchor in accordance with structural analyses  
 X = minimum edge distance in accordance with dowel approval  
 wind-proofing, window waterproofing and fixing in accordance with RAL and/or window manufacturer's specifications.

- 1) Working on front edge analogous to natural stone element surface in agreement with system supplier

### Lintel ventilation StoVentec Stone Massive with stone panel and open joint

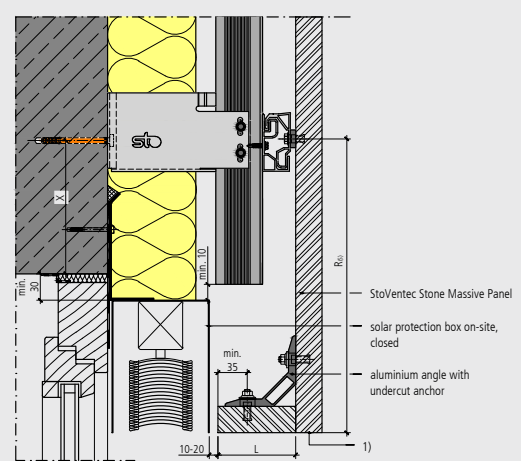

L = permissible projection of reveal element in accordance with structural analyses, minimum dimensions due to reveal angle  
 R<sub>0.5</sub> = edge spacing of undercut anchor in accordance with structural analyses  
 X = minimum edge distance in accordance with dowel approval  
 wind-proofing, window waterproofing and fixing in accordance with RAL and/or window manufacturer's specifications.

- 1) Working on front edge analogous to natural stone element surface in agreement with system supplier

**Notes**  
 When dimensioning the reveal and lintel elements, ensure that the lintel panels are 30 mm higher or the reveal panel is 60 mm longer. This allows overlapping at the corners.

## Fire barrier

### Horizontal fire barrier

#### Horizontal fire barrier in the area of the joints of the vertical carrier profiles<sup>1)</sup>

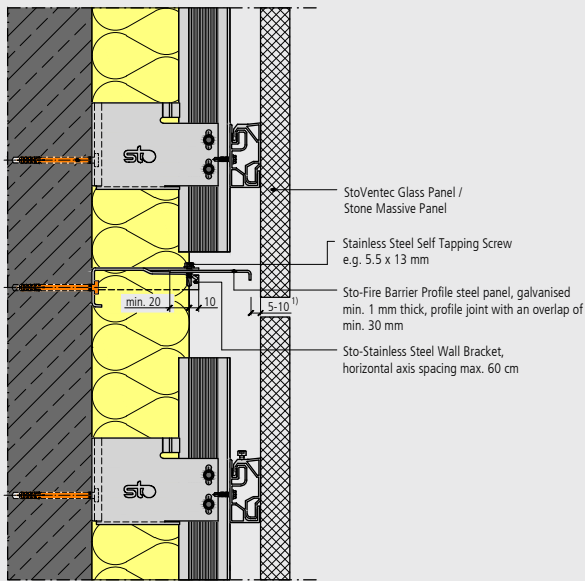

1) Free flow cross-section in the area of the fire barrier, due compliance with national specifications 50-100 cm<sup>2</sup>/m.

<sup>1)</sup> For insulation materials with a melting point below 1,000°C, the fire barrier must be continuously formed between the bare wall and the facade cladding.

#### Notes

To install fire barriers in ventilated facade constructions, the following building code specifications in the respective current version and edition must be considered:

- Sample and/or regional building regulations
- DIN 18516-1
- Sample list of the technical building regulations Part 1, Attachment 2.6/11

The specific design and location of the fire barriers must be coordinated with the fire protection expert responsible for the building project.

## Ceiling cladding

### Ceiling cladding with StoVentec Glass

#### Vertical section parallel (top) and transverse (bottom) to the agraffe

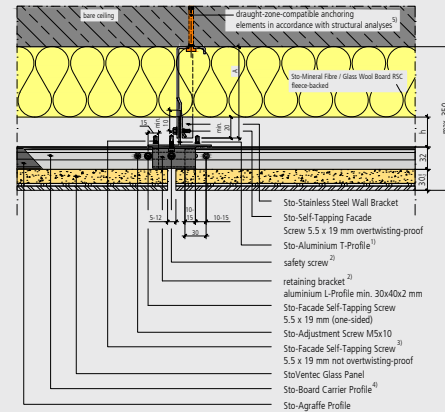

A = projection of wall bracket (see EAG 004)  
h = ventilation airspace at least 20 mm in accordance with DIN 18516 s. h ≤ 150 mm, in case of ceiling planning h min. 30 mm  
If necessary, diagonal reinforcement in accordance with structural specifications.  
Secure ceiling elements with retaining bracket and one retaining bolt on each element to prevent them from becoming detached. Alternatively, fit 2 retaining bolts if zero-stress mounting is assured.

- 1) Arrange profile axes above and, where required, between, the panel joints.
- 2) Torsion-free screw connection in accordance with installation situation, either in the agraffe profile or through the panel joint (joint width min 10 mm, adjust screw head to joint width) in the T-Profile flange.
- 3) For execution see EAG 018
- 4) Rod length agraffe profile see EAG 010 to 016
- 5) If necessary, observe fire protection specifications

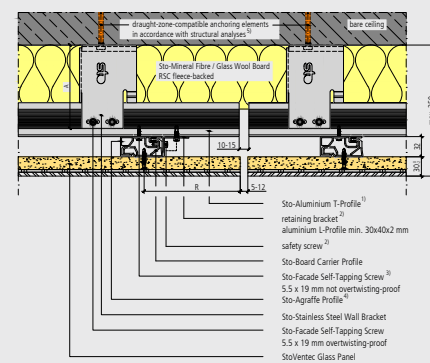

A = projection of wall bracket (see EAG 004)  
If necessary, diagonal reinforcement in accordance with structural specifications.  
Secure ceiling elements with retaining bracket and one retaining bolt on each element to prevent them from becoming detached. Alternatively, fit 2 retaining bolts if zero-stress mounting is assured.

- 1) Arrange profile axes above and, where required, between, the panel joints.
- 2) Torsion-free screw connection in accordance with installation situation, either in the agraffe profile or through the panel joint (min. joint width of 10 mm, match screw head to joint width) in T-profile flange.
- 3) For execution see EAG 018
- 4) Rod length agraffe profile see EAG 010 to 016
- 5) If necessary, observe fire protection specifications

#### Notes

- With suspension heights > 35 cm, it is recommended to fit the wall brackets with vertical pendulum rods and diagonal bracings in both directions.
- Standard detail drawings for the provision of system connections for ceiling claddings are available from Sto AG via [www.sto.com](http://www.sto.com).
- Anchor ceiling installations such as lamps, sprinklers, advertising panels, etc. separately to the bare ceiling. Required penetrations of the glass panels have to be discussed beforehand with the system supplier at the time the working drawings are prepared.
- Where required, observe the fire regulations when selecting the anchoring means.

## Ceiling cladding

### Connection - Ceiling/upward-oriented facade with open joint

#### StoVentec Glass

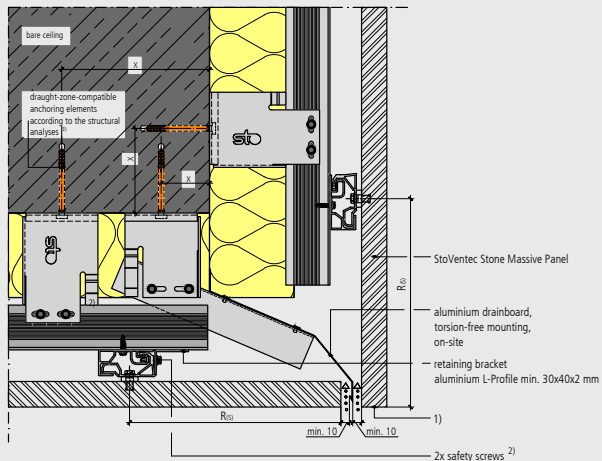

$R_{ei}$  = edge spacing of undercut anchor in accordance with structural analyses  
 $X$  = minimum edge distance in accordance with dowel approval  
If necessary, diagonal reinforcement in accordance with structural specifications.  
Fit the ceiling elements before fitting the drainboard and installing the facade.

- 1) Working on front edge analogous to natural stone element surface in agreement with system supplier
- 2) Torsion-free screw connection in the agraffe profile
- 3) If necessary, observe fire protection specifications.

#### Note

Moisture seeping in through open system joints must be removed according to the design specifications.

## Subsidiaries abroad

Austria  
**Sto Ges.m.b.H.**  
 9500 Villach  
 Phone +43 4242 33133-0  
 www.sto.at

Belgium  
**Sto nv/sa**  
 1730 Asse  
 Phone +32 2 4530110  
 www.sto.be

China  
**Shanghai Sto Ltd.**  
 201201 Shanghai  
 Phone +86 2158 972295  
 www.sto.com.cn

Czech Republic  
**Sto s.r.o.**  
 251 70 Dobřejovice  
 Phone +420 225 996 311  
 www.sto.cz

Denmark  
**Sto Danmark A/S**  
 2650 Hvidovre  
 Phone +45 702 70143  
 www.stodanmark.dk

Finland  
**Sto Finexter Oy**  
 01730 Vantaa  
 Phone +358 207 659191  
 www.stofi.fi

France  
**Sto S.A.S.**  
 95870 Bezons  
 Phone +33 1 34345700  
 www.sto.fr

Hungary  
**Sto Építőanyag Kft.**  
 2330 Dunaharaszti  
 Phone +36 24 510210  
 www.sto.hu

Ireland  
**Sto Ltd.**  
 Dublin 12  
 Phone +353 1460 2305  
 www.sto.ie

Italy  
**Sto Italia srl**  
 50053 Empoli (FI)  
 Phone +39 0571 94701  
 www.stoitalia.it

Malaysia  
**Sto SEA Sdn. Bhd.**  
 Baru Sri Alam  
 81750 Masai  
 Phone +607 388 1737  
 www.sto-sea.com

Netherlands  
**Sto Isoned bv**  
 4004 LH Tiel  
 Phone +31 344 620666  
 www.sto.nl

Norway  
**Sto Norge AS**  
 0175 Oslo  
 Phone +47 6681 3500  
 www.stonorge.no

Poland  
**Sto - ispo Sp. z o.o.**  
 03-872 Warszawa  
 Phone +48 22 5116-102  
 www.sto.pl

Russia  
**OOO Sto**  
 119180 Moskva  
 Phone +7495 974 1584

Singapore  
**Sto SEA Pte Ltd**  
 Singapore 575625  
 Phone +65 64 533080  
 www.sto-sea.com

Slovak Republic  
**Sto s.r.o.**  
**organizačná zložka**  
 83104 Bratislava 3  
 Phone +421 2 44648142

Slovenia  
**Sto Ges.m.b.H.**  
**Podružnica Ljubljana**  
 1000 Ljubljana  
 Phone +386 1 4303 525  
 www.sto.com/si

Spain  
**Sto SDF Ibérica S.L.U.**  
 08302 Mataró (Barcelona)  
 Phone +34 93 7415972  
 www.sto.es

Sweden  
**Sto Scandinavia AB**  
 581 10 Linköping  
 Phone +46 13 377100  
 www.sto.se

Switzerland  
**Sto AG**  
 8172 Niederglatt/ZH  
 Phone +41 44 8515353  
 www.stoag.ch

United Kingdom  
**Sto Ltd.**  
 Glasgow G52 4TG  
 Phone +44 141 404 9000  
 www.sto.co.uk

USA  
**Sto Corp.**  
 Atlanta, GA 30331  
 Phone +1 404 3463666  
 www.stocorp.com

**Head office**  
**Sto AG**  
 Ehrenbachstrasse 1  
 79780 Stuehlingen  
 Germany  
 Phone +49 7744 57-0  
 Fax +49 7744 57-2178  
 infoservice@sto.eu.com  
 www.sto.com



Quality Management System  
 Sto AG, DIN EN ISO 9001, reg.-no. 3651  
 Environmental Management System  
 Sto AG, DIN EN ISO 14001, reg.-no. 3651  
 Plants in Stühlingen, Donsueschingen,  
 Tollwitz, Rüsseßheim, Krißfel