



MORRISON HERSHFIELD

StoVentec Bracket Thermal Analysis



Presented to:

Larry Hilovsky
Director, Rainscreen

Sto Corporation
120-3800 Camp Creek Parkway
Atlanta, GA 30331

Report Number: 20009600
March 11, 2020

TABLE OF CONTENTS

	Page
1. INTRODUCTION	1
2. MODELLING PROCEDURES	4
3. THERMAL RESULTS	5
3.1 StoVentec Bracket with Exterior Insulated Steel Stud Assembly	5
3.2 StoVentec Bracket with Split Insulated Steel Stud Assembly	7
3.3 StoVentec Bracket with Poured-in-Place Concrete	8
3.4 Sensitivity Analysis: Stainless Steel StoVentec Brackets	9
3.5 Sensitivity Analysis: FP Bracket with No Thermal Isolator	15

APPENDIX A: DETAIL DRAWINGS

APPENDIX B: MODELLING PARAMETERS AND ASSUMPTIONS

APPENDIX C: MATERIAL PROPERTIES

APPENDIX D: EFFECTIVE ASSEMBLY R-VALUES

APPENDIX E: SIMULATED TEMPERATURE PROFILES

APPENDIX F: GLOSSARY OF TERMS



1. INTRODUCTION

Morrison Hershfield (MH) was retained by Sto Corporation (Sto) to evaluate the thermal performance of the StoVentec Bracket system for a variety of insulation thicknesses, clip spacing, and backup wall configurations. This report is a summary of the analysis.

The StoVentec Bracket system is composed of two brackets: the fixed point (FP) bracket which is 135 mm high, the movement (GP) bracket which is 95.5 mm high, and a T-rail. A 6 mm thick PVC thermal isolator can be added behind the brackets. The FP bracket supports the cladding dead load and wind load, and the GP brackets allow for movement and resist the cladding wind load only. The StoVentec brackets come in multiple sizes, which are used in combination with the exterior insulation thicknesses shown below in Table 1.1.

Table 1.1: StoVentec Bracket Sizes and Associated Exterior Insulation Thicknesses

Bracket Size	Exterior Insulation Thickness in (mm)	Bracket Size	Exterior Insulation Thickness in (mm)
40	1 (25)	200	7 (178)
60	1 (25)	220	8 (203)
80	2 (51)	240	8 (203)
100	3 (76)	260	9 (229)
120	4 (102)	280	10 (254)
140	4 (102)	300	11 (279)
160	5 (127)	320	12 (305)
180	6 (152)		

The StoVentec brackets are available in aluminum and stainless steel. A sensitivity analysis was performed to determine the impact of the bracket material and contribution of the thermal isolator to the overall R-value and point transmittances of the StoVentec system.

Table 1.2 below summarizes the evaluated wall configurations, and Figure 1.1 illustrates representative configurations for all backup wall types. The geometry of the GP and FP brackets as well as T-Rail were based on the drawings provided by Sto, and are provided in Appendix A.

Table 1.2: Evaluated StoVentec Bracket Assemblies

Schematic Diagram Figure 1.1	Sto Bracket System	Backup Wall	Bracket Size	Stud Spacing in	Horizontal Clip Spacing in	Vertical Clip Spacing in
A	Aluminum GP, FP	6" Steel Stud, Uninsulated Cavity	80, 120, 160, 220	16	16, 32	24, 36, 48
B	Aluminum GP, FP	6" Steel Stud, R-19 Batt Insulation in Cavity	80, 120, 160, 220	16	16, 32	24, 36, 48
C	Aluminum GP, FP	8" Poured-in-Place Concrete	80, 120, 160, 220	--	16, 32	24, 36, 48
A	Stainless Steel GP, FP	6" Steel Stud, Uninsulated Cavity	80, 120, 160, 220	16	16	24, 48
B	Stainless Steel GP, FP	6" Steel Stud, R-19 Batt Insulation in Cavity	80, 120, 160, 220	16	16	24, 48
C	Stainless Steel GP, FP	8" Poured-in-Place Concrete	80, 120, 160, 220	--	16	24, 48
A	Aluminum FP, No Thermal Isolator	6" Steel Stud, Uninsulated Cavity	80, 160, 220	16	16	24
B	Aluminum FP, No Thermal Isolator	6" Steel Stud, R-19 Batt Insulation in Cavity	80, 160, 220	16	16	24
A	Stainless Steel FP, No Thermal Isolator	6" Steel Stud, Uninsulated Cavity	80, 160, 220	16	16	24
B	Stainless Steel FP, No Thermal Isolator	6" Steel Stud, R-19 Batt Insulation in Cavity	80, 160, 220	16	16	24

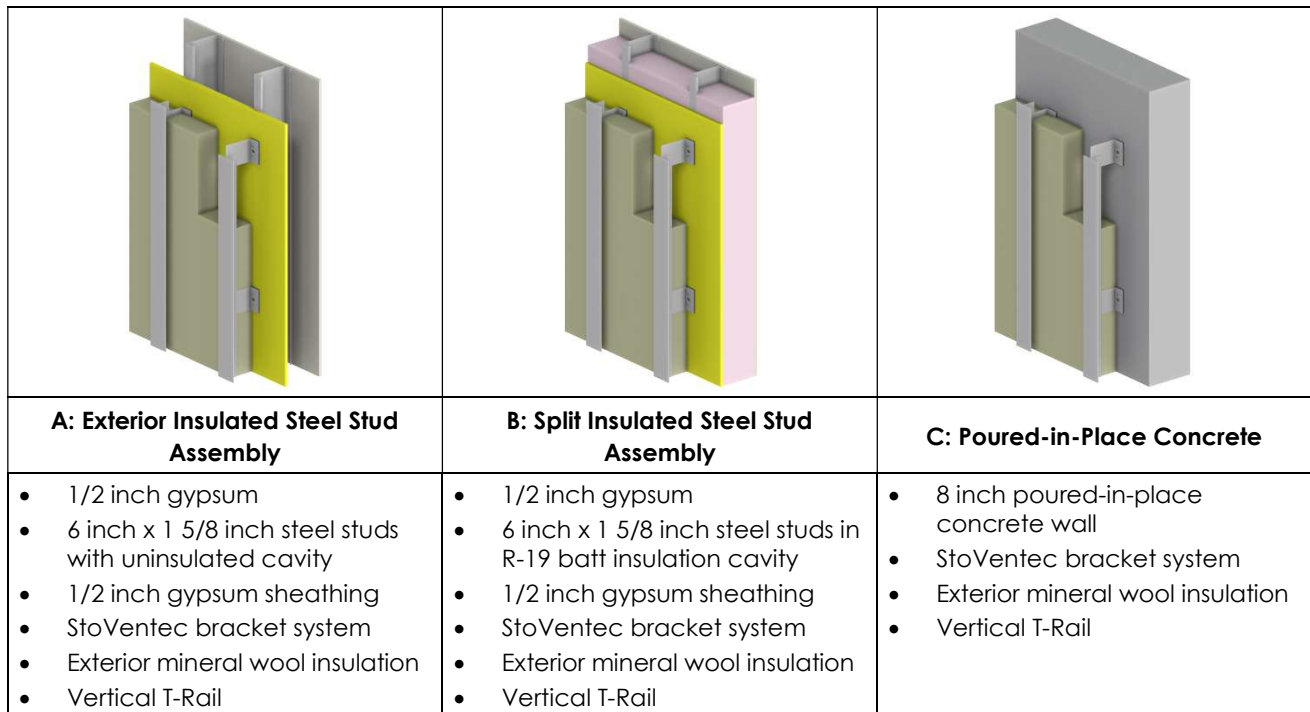
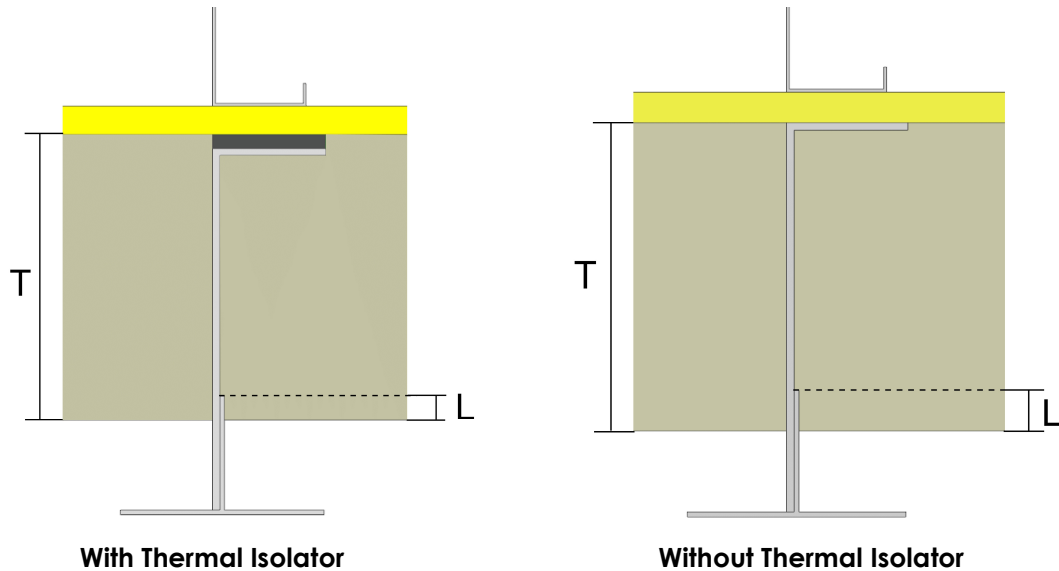

Figure 1.1: Schematics of Evaluated StoVentec GP and FP Bracket Assemblies

The StoVentec brackets are used in conjunction with a T-Rail profile, adjusted such that the face of the T-Rail is against the face of the StoVentec bracket. With this configuration the rail penetrates the exterior insulation, as shown below in Figure 1.2.



StoVentec Bracket Size	Insulation Thickness T in (mm)	With Thermal Isolator	Without Thermal Isolator
		L in (mm)	L in (mm)
80	2 (51)	0.58 (15)	0.82 (21)
120	4 (102)	1.0 (26)	Not modelled
160	5 (127)	0.43 (11)	0.67 (17)
220	8 (203)	1.1 (27)	1.3 (33)

Figure 1.2: T-Rail Penetration Depths for the StoVentec Bracket System

2. MODELLING PROCEDURES

The thermal performance of the different assembly scenarios was evaluated by 3D thermal modelling using the Nx software package from Siemens, which is a general purpose computer aided design (CAD) and finite element analysis (FEA) package. The thermal solver and modelling procedures utilized for this study were extensively calibrated and validated to within +/- 5% of hotbox testing for *ASHRAE Research Project 1365-RP Thermal Performance of Building Envelope Details for Mid- and High-Rise Construction and for the Building Envelope Thermal Bridging Guide*¹. The thermal analysis utilized steady-state conditions, published thermal properties of materials and information provided by Sto. Additional assumptions for the thermal analysis are listed in Appendix B. Further assembly information, including material properties, are given in Appendix C.

The U-value and overall R-value of the GP and FP bracket assemblies were calculated, as well as the incremental increase in thermal loss of the FP bracket compared to the GP bracket. The intent of this approach is for Sto to be able to adjust the clear wall U-value and effective R-value of a GP wall assembly by factoring in the additional heat loss of the FP brackets applying the incremental increase in thermal loss for each FP bracket. Further information as to this calculation is provided in Appendix B.4.

For the sensitivity analysis comparing the thermal performance of the aluminum and stainless steel brackets, the aluminum bracket geometry was modified to change the thickness and material properties. This is a slightly conservative comparison as the stainless steel GP and FP bracket mounting footprints (GP: 75mm x 50mm and FP: 130mm x 50mm) are smaller than the aluminum bracket footprints (GP: 95.5mm x 50mm and FP: 135mm x 50mm).

1 <https://www.bchydro.com/thermalguide>

3. THERMAL RESULTS

The U-values for all aluminum GP and FP bracket assembly configurations are shown below. The effective R-values for all GP bracket assembly configurations can be found in Appendix D. Example temperature profiles for each configuration are provided in Appendix E.

3.1 StoVentec Bracket with Exterior Insulated Steel Stud Assembly

Table 3.1.1: U-Value for GP Bracket with Exterior Insulated Steel Stud Assemblies²

Horizontal Bracket Spacing in	StoVentec Bracket Size	Exterior Insulation Thickness in	Exterior Insulation Nominal R-Value ³ ft ² hr °F/Btu (m ² °K/W)	U-Value Btu/h ft ² °F (W/m ² °K)		
				24" Vertical Bracket Spacing	36" Vertical Bracket Spacing	48" Vertical Bracket Spacing
16	80	2	R-8.4 (1.48 RSI)	0.099 (0.56)	0.096 (0.55)	0.094 (0.53)
	120	4	R-16.8 (2.96 RSI)	0.068 (0.39)	0.062 (0.35)	0.060 (0.34)
	160	5	R-21.0 (3.70 RSI)	0.060 (0.34)	0.054 (0.31)	0.051 (0.29)
	220	8	R-33.6 (5.92 RSI)	0.048 (0.27)	0.041 (0.23)	0.038 (0.21)
32	80	2	R-8.4 (1.48 RSI)	0.093 (0.53)	0.091 (0.51)	0.090 (0.51)
	120	4	R-16.8 (2.96 RSI)	0.059 (0.34)	0.055 (0.31)	0.054 (0.31)
	160	5	R-21.0 (3.70 RSI)	0.051 (0.29)	0.047 (0.27)	0.046 (0.26)
	220	8	R-33.6 (5.92 RSI)	0.038 (0.21)	0.033 (0.19)	0.032 (0.18)

² Data used in example calculation in Appendix B.4

³ This value is the nominal R-value of the exterior insulation ONLY. Additional components, such as the sheathing, batt insulation, and air films all contribute an additional R-3.2 towards the nominal R-value of the entire assembly.



Table 3.1.2: U-Value for FP Bracket with Exterior Insulated Steel Stud Assemblies⁴

Horizontal Bracket Spacing in	StoVentec Bracket Size	Exterior Insulation Thickness in	Exterior Insulation Nominal R-Value ⁵ ft ² hr °F/Btu (m ² °K/W)	U-Value Btu/h ft ² °F (W/m ² °K)			Incremental FP Bracket Point Transmittance Increase from GP Btu/hr °F (W/°K)		
				24" Vertical Bracket Spacing	36" Vertical Bracket Spacing	48" Vertical Bracket Spacing	24" Vertical Bracket Spacing	36" Vertical Bracket Spacing	48" Vertical Bracket Spacing
16	80	2	R-8.4 (1.48 RSI)	0.104 (0.59)	0.099 (0.56)	0.096 (0.54)	0.015 (0.0079)	0.010 (0.0053)	0.010 (0.0052)
	120	4	R-16.8 (2.96 RSI)	0.073 (0.41)	0.066 (0.37)	0.062 (0.35)	0.013 (0.0066)	0.013 (0.0068)	0.013 (0.0068)
	160	5	R-21.0 (3.70 RSI)	0.065 (0.37)	0.057 (0.33)	0.053 (0.30)	0.014 (0.0072)	0.014 (0.0075)	0.014 (0.0074)
	220	8	R-33.6 (5.92 RSI)	0.053 (0.30)	0.045 (0.26)	0.041 (0.23)	0.015 (0.0078)	0.015 (0.0080)	0.015 (0.0081)
32	80	2	R-8.4 (1.48 RSI)	0.095 (0.54)	0.093 (0.53)	0.091 (0.52)	0.010 (0.0053)	0.015 (0.0080)	0.016 (0.0083)
	120	4	R-16.8 (2.96 RSI)	0.061 (0.35)	0.058 (0.33)	0.056 (0.32)	0.013 (0.0066)	0.021 (0.0111)	0.021 (0.0113)
	160	5	R-21.0 (3.70 RSI)	0.053 (0.30)	0.049 (0.28)	0.047 (0.27)	0.014 (0.0073)	0.019 (0.0101)	0.019 (0.0100)
	220	8	R-33.6 (5.92 RSI)	0.040 (0.23)	0.036 (0.21)	0.034 (0.19)	0.015 (0.0078)	0.024 (0.0126)	0.024 (0.0126)

⁴ Data used in example calculation in Appendix B.4

⁵ This value is the nominal R-value of the exterior insulation ONLY. Additional components, such as the sheathing, batt insulation, and air films all contribute an additional R-3.2 towards the nominal R-value of the entire assembly.



3.2 StoVentec Bracket with Split Insulated Steel Stud Assembly

Table 3.2.1: U-Value for GP Bracket with Split Insulated Steel Stud Assemblies

Horizontal Bracket Spacing in	StoVentec Bracket Size	Exterior Insulation Thickness in	Exterior Insulation Nominal R-Value ⁶ ft ² hr °F/Btu (m ² °K/W)	U-Value Btu/h ft ² °F (W/m ² °K)		
				24" Vertical Bracket Spacing	36" Vertical Bracket Spacing	48" Vertical Bracket Spacing
16	80	2	R-8.4 (1.48 RSI)	0.054 (0.31)	0.053 (0.30)	0.052 (0.29)
	120	4	R-16.8 (2.96 RSI)	0.044 (0.25)	0.041 (0.23)	0.039 (0.22)
	160	5	R-21.0 (3.70 RSI)	0.041 (0.23)	0.037 (0.21)	0.035 (0.20)
	220	8	R-33.6 (5.92 RSI)	0.035 (0.20)	0.031 (0.17)	0.029 (0.16)
32	80	2	R-8.4 (1.48 RSI)	0.052 (0.29)	0.050 (0.29)	0.050 (0.28)
	120	4	R-16.8 (2.96 RSI)	0.039 (0.22)	0.037 (0.21)	0.036 (0.21)
	160	5	R-21.0 (3.70 RSI)	0.035 (0.20)	0.033 (0.19)	0.032 (0.18)
	220	8	R-33.6 (5.92 RSI)	0.028 (0.16)	0.026 (0.15)	0.025 (0.14)

Table 3.2.2: U-Value for FP Bracket with Split Insulated Steel Stud Assemblies

Horizontal Bracket Spacing in	StoVentec Bracket Size	Exterior Insulation Thickness in	Exterior Insulation Nominal R-Value ⁶ ft ² hr °F/Btu (m ² °K/W)	U-Value Btu/h ft ² °F (W/m ² °K)			Incremental FP Bracket Point Transmittance Increase from GP Btu/hr °F (W/°K)		
				24" Vertical Bracket Spacing	36" Vertical Bracket Spacing	48" Vertical Bracket Spacing	24" Vertical Bracket Spacing	36" Vertical Bracket Spacing	48" Vertical Bracket Spacing
16	80	2	R-8.4 (1.48 RSI)	0.057 (0.32)	0.054 (0.31)	0.053 (0.30)	0.007 (0.0034)	0.005 (0.0024)	0.004 (0.0023)
	120	4	R-16.8 (2.96 RSI)	0.046 (0.26)	0.043 (0.24)	0.041 (0.23)	0.006 (0.0032)	0.006 (0.0034)	0.006 (0.0033)
	160	5	R-21.0 (3.70 RSI)	0.043 (0.25)	0.039 (0.22)	0.037 (0.21)	0.007 (0.0037)	0.007 (0.0039)	0.007 (0.0039)
	220	8	R-33.6 (5.92 RSI)	0.038 (0.21)	0.033 (0.19)	0.030 (0.17)	0.008 (0.0042)	0.008 (0.0045)	0.009 (0.0045)
32	80	2	R-8.4 (1.48 RSI)	0.052 (0.30)	0.051 (0.29)	0.050 (0.29)	0.004 (0.0022)	0.006 (0.0034)	0.006 (0.0032)
	120	4	R-16.8 (2.96 RSI)	0.040 (0.23)	0.038 (0.22)	0.037 (0.21)	0.006 (0.0032)	0.010 (0.0053)	0.010 (0.0053)
	160	5	R-21.0 (3.70 RSI)	0.037 (0.21)	0.034 (0.20)	0.033 (0.19)	0.007 (0.0036)	0.010 (0.0051)	0.009 (0.0050)
	220	8	R-33.6 (5.92 RSI)	0.030 (0.17)	0.027 (0.16)	0.026 (0.15)	0.008 (0.0042)	0.013 (0.0070)	0.013 (0.0070)

⁶ This value is the nominal R-value of the exterior insulation ONLY. Additional components, such as the sheathing, batt insulation, and air films all contribute an additional R-21.3 towards the nominal R-value of the entire assembly.



3.3 StoVentec Bracket with Poured-in-Place Concrete

Table 3.3.1: U-Value for GP Bracket with Poured-in-Place Concrete

Horizontal Bracket Spacing in	StoVentec Bracket Size	Exterior Insulation Thickness in	Exterior Insulation Nominal R-Value ⁷ ft ² hr °F/Btu (m ² °K/W)	U-Value Btu/h ft ² °F (W/m ² °K)		
				24" Vertical Bracket Spacing	36" Vertical Bracket Spacing	48" Vertical Bracket Spacing
16	80	2	R-8.4 (1.48 RSI)	0.114 (0.65)	0.111 (0.63)	0.108 (0.61)
	120	4	R-16.8 (2.96 RSI)	0.079 (0.45)	0.071 (0.40)	0.067 (0.38)
	160	5	R-21.0 (3.70 RSI)	0.070 (0.40)	0.061 (0.35)	0.057 (0.32)
	220	8	R-33.6 (5.92 RSI)	0.056 (0.32)	0.047 (0.27)	0.043 (0.24)
32	80	2	R-8.4 (1.48 RSI)	0.107 (0.61)	0.102 (0.58)	0.101 (0.57)
	120	4	R-16.8 (2.96 RSI)	0.066 (0.38)	0.060 (0.34)	0.059 (0.33)
	160	5	R-21.0 (3.70 RSI)	0.057 (0.32)	0.051 (0.29)	0.049 (0.28)
	220	8	R-33.6 (5.92 RSI)	0.042 (0.24)	0.036 (0.20)	0.034 (0.19)

Table 3.3.2: U-Value for FP Bracket with Poured-in-Place Concrete

Horizontal Bracket Spacing in	StoVentec Bracket Size	Exterior Insulation Thickness in	Exterior Insulation Nominal R-Value ⁷ ft ² hr °F/Btu (m ² °K/W)	U-Value Btu/h ft ² °F (W/m ² °K)			Incremental FP Bracket Point Transmittance Increase from GP Btu/hr °F (W/°K)		
				24" Vertical Bracket Spacing	36" Vertical Bracket Spacing	48" Vertical Bracket Spacing	24" Vertical Bracket Spacing	36" Vertical Bracket Spacing	48" Vertical Bracket Spacing
16	80	2	R-8.4 (1.48 RSI)	0.124 (0.71)	0.115 (0.66)	0.111 (0.63)	0.027 (0.0140)	0.017 (0.0092)	0.018 (0.0093)
	120	4	R-16.8 (2.96 RSI)	0.086 (0.49)	0.076 (0.43)	0.071 (0.40)	0.020 (0.0104)	0.020 (0.0107)	0.020 (0.0108)
	160	5	R-21.0 (3.70 RSI)	0.078 (0.44)	0.067 (0.38)	0.061 (0.35)	0.021 (0.0111)	0.022 (0.0114)	0.022 (0.0115)
	220	8	R-33.6 (5.92 RSI)	0.064 (0.37)	0.053 (0.30)	0.047 (0.27)	0.022 (0.0114)	0.022 (0.0118)	0.023 (0.0119)
32	80	2	R-8.4 (1.48 RSI)	0.110 (0.63)	0.106 (0.60)	0.103 (0.59)	0.018 (0.0093)	0.027 (0.0145)	0.028 (0.0147)
	120	4	R-16.8 (2.96 RSI)	0.070 (0.40)	0.065 (0.37)	0.062 (0.35)	0.020 (0.0106)	0.034 (0.0180)	0.035 (0.0183)
	160	5	R-21.0 (3.70 RSI)	0.061 (0.34)	0.055 (0.31)	0.052 (0.30)	0.022 (0.0114)	0.031 (0.0162)	0.030 (0.0160)
	220	8	R-33.6 (5.92 RSI)	0.046 (0.26)	0.041 (0.23)	0.038 (0.21)	0.022 (0.0116)	0.036 (0.0191)	0.036 (0.0191)

⁷ This value is the nominal R-value of the exterior insulation ONLY. Additional components, such as the sheathing, batt insulation, and air films all contribute an additional R-2.0 towards the nominal R-value of the entire assembly.



3.4 Sensitivity Analysis: Stainless Steel StoVentec Brackets

The U-values for all stainless steel GP and FP bracket assembly configurations are shown below. The effective R-values for all bracket assembly configurations can be found in Appendix D. For comparison, the analogous aluminum StoVentec bracket results are also presented in the tables.

For the GP bracket assemblies, the difference in R-value of the stainless steel bracket assemblies compared to the aluminum bracket assemblies is presented. For the FP bracket assemblies, the increase in U-value of the FP bracket assembly compared to the analogous GP bracket assembly is presented.

Table 3.4.1: U-Value for Aluminum vs. Stainless Steel GP Bracket for 16" o.c. Horizontal Bracket Spacing, Exterior Insulated Steel Stud

Vertical Bracket Spacing in	StoVentec Bracket Size	Exterior Insulation Thickness in	Exterior Insulation Nominal R-Value ⁸ ft ² hr °F/Btu (m ² °K/W)	U-Value Btu/h ft ² °F (W/m ² °K)		Difference in R-Value ft ² hr °F/Btu (m ² °K/W)
				Aluminum Bracket	Stainless Steel Bracket	
24	80	2	R-8.4 (1.48 RSI)	0.099 (0.56)	0.097 (0.55)	R-0.2 (0.04)
	120	4	R-16.8 (2.96 RSI)	0.068 (0.39)	0.060 (0.34)	R-1.8 (0.32)
	160	5	R-21.0 (3.70 RSI)	0.060 (0.34)	0.050 (0.28)	R-3.4 (0.59)
	220	8	R-33.6 (5.92 RSI)	0.048 (0.27)	0.035 (0.20)	R-7.9 (1.40)
48	80	2	R-8.4 (1.48 RSI)	0.094 (0.53)	0.092 (0.52)	R-0.2 (0.04)
	120	4	R-16.8 (2.96 RSI)	0.060 (0.34)	0.056 (0.32)	R-1.1 (0.20)
	160	5	R-21.0 (3.70 RSI)	0.051 (0.29)	0.046 (0.26)	R-2.2 (0.39)
	220	8	R-33.6 (5.92 RSI)	0.038 (0.21)	0.031 (0.18)	R-5.7 (1.00)

⁸ This value is the nominal R-value of the exterior insulation ONLY. Additional components, such as the sheathing, batt insulation, and air films all contribute an additional R-3.2 towards the nominal R-value of the entire assembly.



Table 3.4.2: U-Value for Aluminum vs. Stainless Steel FP Bracket for 16" o.c. Horizontal Bracket Spacing, Exterior Insulated Steel Stud

Vertical Bracket Spacing in	StoVentec Bracket Size	Exterior Insulation Thickness in	Exterior Insulation Nominal R-Value ⁹ ft ² hr °F/Btu (m ² °K/W)	U-Value Btu/h ft ² °F (W/m ² °K)		Incremental FP Bracket Point Transmittance Increase from GP Btu/hr °F (W/°K)	
				Aluminum	Stainless Steel	Aluminum	Stainless Steel
24	80	2	R-8.4 (1.48 RSI)	0.104 (0.59)	0.100 (0.57)	0.015 (0.0079)	0.010 (0.005)
	120	4	R-16.8 (2.96 RSI)	0.073 (0.41)	0.065 (0.37)	0.013 (0.0066)	0.011 (0.006)
	160	5	R-21.0 (3.70 RSI)	0.065 (0.37)	0.054 (0.31)	0.014 (0.0072)	0.011 (0.006)
	220	8	R-33.6 (5.92 RSI)	0.053 (0.30)	0.039 (0.22)	0.015 (0.0078)	0.011 (0.006)
48	80	2	R-8.4 (1.48 RSI)	0.096 (0.54)	0.094 (0.53)	0.010 (0.0052)	0.010 (0.005)
	120	4	R-16.8 (2.96 RSI)	0.062 (0.35)	0.058 (0.33)	0.013 (0.0068)	0.012 (0.006)
	160	5	R-21.0 (3.70 RSI)	0.053 (0.30)	0.048 (0.27)	0.014 (0.0074)	0.011 (0.006)
	220	8	R-33.6 (5.92 RSI)	0.041 (0.23)	0.033 (0.19)	0.015 (0.0081)	0.011 (0.006)

⁹ This value is the nominal R-value of the exterior insulation ONLY. Additional components, such as the sheathing, batt insulation, and air films all contribute an additional R-3.2 towards the nominal R-value of the entire assembly.



Table 3.4.3: U-Value for Aluminum vs. Stainless Steel GP Bracket for 16" o.c. Horizontal Bracket Spacing, Split Insulated Steel Stud

Vertical Bracket Spacing in	StoVentec Bracket Size	Exterior Insulation Thickness in	Exterior Insulation Nominal R-Value ¹⁰ ft ² hr °F/Btu (m ² °K/W)	U-Value Btu/h ft ² °F (W/m ² °K)		Difference in R-Value ft ² hr °F/Btu (m ² °K/W)
				Aluminum Bracket	Stainless Steel Bracket	
24	80	2	R-8.4 (1.48 RSI)	0.054 (0.31)	0.053 (0.30)	R-0.3 (0.05)
	120	4	R-16.8 (2.96 RSI)	0.044 (0.25)	0.040 (0.23)	R-2.1 (0.38)
	160	5	R-21.0 (3.70 RSI)	0.041 (0.23)	0.035 (0.20)	R-3.8 (0.67)
	220	8	R-33.6 (5.92 RSI)	0.035 (0.20)	0.027 (0.15)	R-8.3 (1.47)
48	80	2	R-8.4 (1.48 RSI)	0.052 (0.29)	0.051 (0.29)	R-0.3 (0.06)
	120	4	R-16.8 (2.96 RSI)	0.039 (0.22)	0.038 (0.21)	R-1.3 (0.24)
	160	5	R-21.0 (3.70 RSI)	0.035 (0.20)	0.033 (0.19)	R-2.4 (0.43)
	220	8	R-33.6 (5.92 RSI)	0.029 (0.16)	0.024 (0.14)	R-5.9 (1.03)

Table 3.4.4: U-Value for Aluminum vs. Stainless Steel FP Bracket for 16" o.c. Horizontal Bracket Spacing, Split Insulated Steel Stud

Vertical Bracket Spacing in	StoVentec Bracket Size	Exterior Insulation Thickness in	Exterior Insulation Nominal R-Value ¹⁰ ft ² hr °F/Btu (m ² °K/W)	U-Value Btu/h ft ² °F (W/m ² °K)		Incremental FP Bracket Point Transmittance Increase from GP Btu/hr °F (W/°K)	
				Aluminum	Stainless Steel	Aluminum	Stainless Steel
24	80	2	R-8.4 (1.48 RSI)	0.057 (0.32)	0.055 (0.31)	0.007 (0.0034)	0.004 (0.002)
	120	4	R-16.8 (2.96 RSI)	0.046 (0.26)	0.043 (0.24)	0.006 (0.0032)	0.006 (0.003)
	160	5	R-21.0 (3.70 RSI)	0.043 (0.25)	0.038 (0.21)	0.007 (0.0037)	0.007 (0.004)
	220	8	R-33.6 (5.92 RSI)	0.038 (0.21)	0.030 (0.17)	0.008 (0.0042)	0.007 (0.004)
48	80	2	R-8.4 (1.48 RSI)	0.053 (0.30)	0.052 (0.29)	0.004 (0.0023)	0.004 (0.002)
	120	4	R-16.8 (2.96 RSI)	0.041 (0.23)	0.039 (0.22)	0.006 (0.0033)	0.006 (0.003)
	160	5	R-21.0 (3.70 RSI)	0.037 (0.21)	0.034 (0.19)	0.007 (0.0039)	0.007 (0.004)
	220	8	R-33.6 (5.92 RSI)	0.030 (0.17)	0.026 (0.15)	0.009 (0.0045)	0.007 (0.004)

¹⁰ This value is the nominal R-value of the exterior insulation ONLY. Additional components, such as the sheathing, batt insulation, and air films all contribute an additional R-21.3 towards the nominal R-value of the entire assembly.



Table 3.4.5: U-Value for Aluminum vs. Stainless Steel GP Bracket for 16" o.c. Horizontal Bracket Spacing, Poured-in-Place Concrete

Vertical Bracket Spacing in	StoVentec Bracket Size	Exterior Insulation Thickness in	Exterior Insulation Nominal R-Value ¹¹ ft ² hr °F/Btu (m ² °K/W)	U-Value Btu/h ft ² °F (W/m ² °K)		Difference in R-Value ft ² hr °F/Btu (m ² °K/W)
				Aluminum Bracket	Stainless Steel Bracket	
24	80	2	R-8.4 (1.48 RSI)	0.114 (0.65)	0.110 (0.63)	R-0.3 (0.06)
	120	4	R-16.8 (2.96 RSI)	0.079 (0.45)	0.066 (0.38)	R-2.4 (0.43)
	160	5	R-21.0 (3.70 RSI)	0.070 (0.40)	0.054 (0.30)	R-4.3 (0.76)
	220	8	R-33.6 (5.92 RSI)	0.056 (0.32)	0.037 (0.21)	R-9.5 (1.68)
48	80	2	R-8.4 (1.48 RSI)	0.108 (0.61)	0.104 (0.59)	R-0.4 (0.06)
	120	4	R-16.8 (2.96 RSI)	0.067 (0.38)	0.060 (0.34)	R-1.6 (0.29)
	160	5	R-21.0 (3.70 RSI)	0.057 (0.32)	0.049 (0.28)	R-3.0 (0.52)
	220	8	R-33.6 (5.92 RSI)	0.043 (0.24)	0.033 (0.18)	R-7.2 (1.28)

Table 3.4.6: U-Value for Aluminum vs. Stainless Steel FP Bracket for 16" o.c. Horizontal Bracket Spacing, Poured-in-Place Concrete

Vertical Bracket Spacing in	StoVentec Bracket Size	Exterior Insulation Thickness in	Exterior Insulation Nominal R-Value ¹¹ ft ² hr °F/Btu (m ² °K/W)	U-Value Btu/h ft ² °F (W/m ² °K)		Incremental FP Bracket Point Transmittance Increase from GP Btu/hr °F (W/°K)	
				Aluminum	Stainless Steel	Aluminum	Stainless Steel
24	80	2	R-8.4 (1.48 RSI)	0.124 (0.71)	0.116 (0.66)	0.027 (0.0140)	0.015 (0.008)
	120	4	R-16.8 (2.96 RSI)	0.086 (0.49)	0.072 (0.41)	0.020 (0.0104)	0.016 (0.008)
	160	5	R-21.0 (3.70 RSI)	0.078 (0.44)	0.059 (0.34)	0.021 (0.0111)	0.015 (0.008)
	220	8	R-33.6 (5.92 RSI)	0.064 (0.37)	0.042 (0.24)	0.022 (0.0114)	0.013 (0.007)
48	80	2	R-8.4 (1.48 RSI)	0.111 (0.63)	0.107 (0.61)	0.018 (0.0093)	0.016 (0.009)
	120	4	R-16.8 (2.96 RSI)	0.071 (0.40)	0.063 (0.36)	0.020 (0.0108)	0.016 (0.009)
	160	5	R-21.0 (3.70 RSI)	0.061 (0.35)	0.052 (0.29)	0.022 (0.0115)	0.015 (0.008)
	220	8	R-33.6 (5.92 RSI)	0.047 (0.27)	0.035 (0.20)	0.023 (0.0119)	0.013 (0.007)

To illustrate the difference in the thermal performance of the aluminum and stainless steel GP bracket, the nominal vs. effective R-values for the three backup wall configurations are shown below in Figure 3.4.1 through 3.4.3.

¹¹ This value is the nominal R-value of the exterior insulation ONLY. Additional components, such as the sheathing, batt insulation, and air films all contribute an additional R-2.0 towards the nominal R-value of the entire assembly.



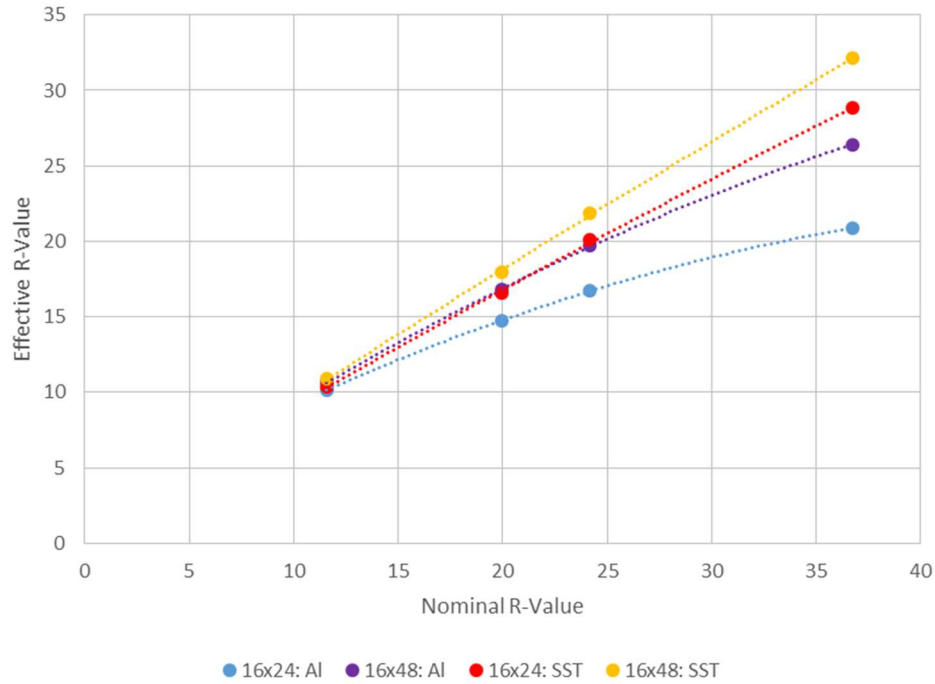

Figure 3.4.1: Nominal vs. Effective R-value of the Aluminum and Stainless Steel GP Bracket Spaced 16" o.c. Horizontally, Exterior Insulated Steel Stud Assembly (Table D7)

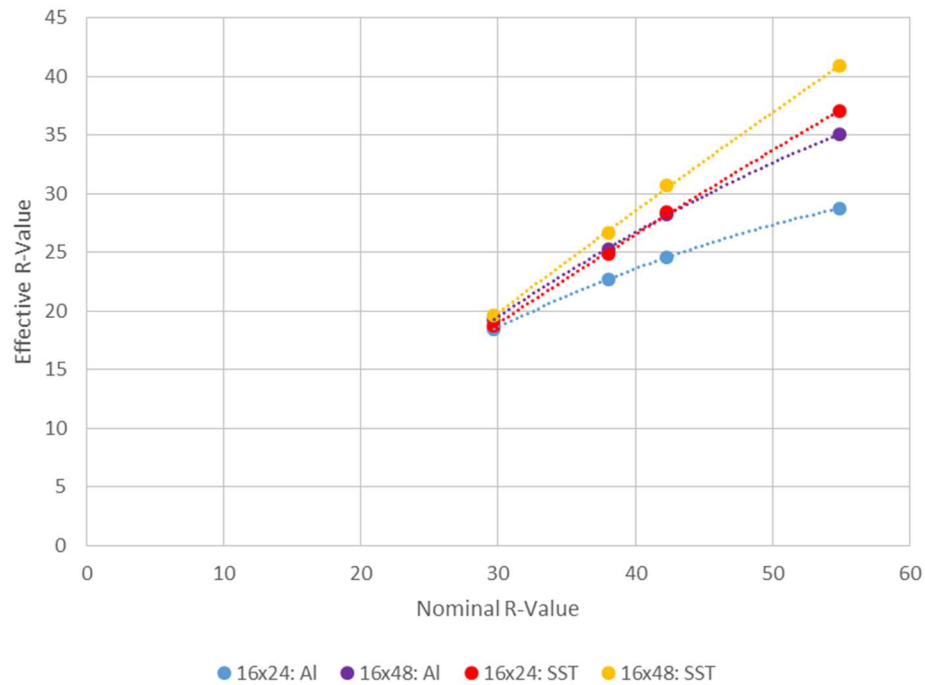

Figure 3.4.2: Nominal vs. Effective R-value of the Aluminum and Stainless Steel GP Bracket Spaced 16" o.c. Horizontally, Split Insulated Steel Stud Assembly (Table D9)

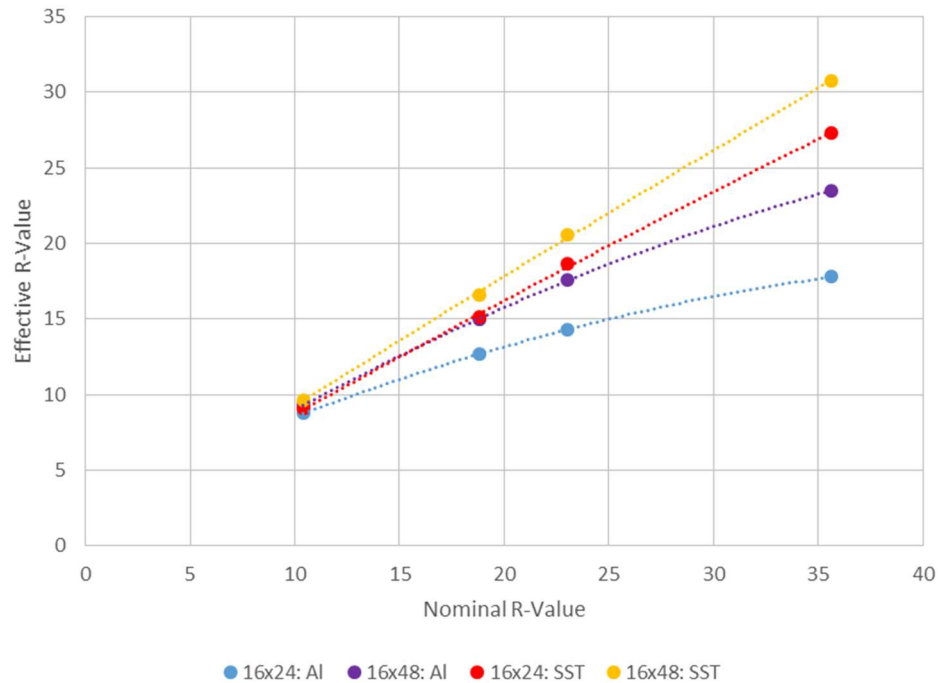

Figure 3.4.3: Nominal vs. Effective R-value of the Aluminum and Stainless Steel GP Bracket Spaced 16" o.c. Horizontally, Poured-in-Place Concrete (Table D11)

Discussion

As shown in Figures 3.4.1 to 3.4.3, the thermal performance of the stainless steel bracket is better than the aluminum bracket, with the difference in effective R-values between the stainless steel and aluminum brackets increasing with increasing exterior insulation thickness. Of the assemblies evaluated, the largest difference in effective R-value is for the 16 inch o.c. horizontal by 48 o.c. vertical bracket spacing at 8 inches exterior insulation (R-33.6), where the effective R-value of the stainless steel GP bracket is R-9.5 greater than the equivalent aluminum GP bracket.

3.5 Sensitivity Analysis: FP Bracket with No Thermal Isolator

The U-values of the FP brackets without the thermal isolator are shown below. For comparison, the FP bracket results with the thermal isolator are also presented in the tables as well as the increase in R-value of the assembly with the thermal isolator compared to without. The effective R-values for all bracket assembly configurations can be found in Appendix D.

Table 3.5.1: U-value for FP Bracket for 16" o.c. x 24" o.c. Bracket Spacing, with and without the Thermal Isolator, Exterior Insulated Steel Stud Assembly

Bracket Material	StoVentec Bracket Size	Exterior Insulation Thickness in	Exterior Insulation Nominal R-Value ¹² ft ² hr °F/Btu (m ² °K/W)	U-Value Btu/h ft ² °F (W/m ² °K)		Incremental FP Bracket Point Transmittance Increase Btu/hr °F (W/°K)
				Without Thermal Isolator	With Thermal Isolator	
Aluminum	80	2	R-8.4 (1.48 RSI)	0.115 (0.65)	0.104 (0.59)	0.029 (0.015)
	160	5	R-21.0 (3.70 RSI)	0.076 (0.43)	0.065 (0.37)	0.030 (0.016)
	220	8	R-33.6 (5.92 RSI)	0.064 (0.36)	0.053 (0.30)	0.028 (0.015)
Stainless Steel	80	2	R-8.4 (1.48 RSI)	0.107 (0.61)	0.100 (0.57)	0.017 (0.009)
	160	5	R-21.0 (3.70 RSI)	0.057 (0.33)	0.054 (0.31)	0.008 (0.004)
	220	8	R-33.6 (5.92 RSI)	0.041 (0.23)	0.039 (0.22)	0.005 (0.003)

Table 3.5.2: U-value for FP Bracket for 16" o.c. x 24" o.c. Bracket Spacing, with and without the Thermal Isolator, Split Insulated Steel Stud Assembly

Bracket Material	StoVentec Bracket Size	Exterior Insulation Thickness in	Exterior Insulation Nominal R-Value ¹³ ft ² hr °F/Btu (m ² °K/W)	U-Value Btu/h ft ² °F (W/m ² °K)		Incremental FP Bracket Point Transmittance Increase Btu/hr °F (W/°K)
				Without Thermal Isolator	With Thermal Isolator	
Aluminum	80	2	R-8.4 (1.48 RSI)	0.061 (0.35)	0.057 (0.32)	0.011 (0.006)
	160	5	R-21.0 (3.70 RSI)	0.048 (0.27)	0.043 (0.25)	0.013 (0.007)
	220	8	R-33.6 (5.92 RSI)	0.043 (0.24)	0.038 (0.21)	0.014 (0.007)
Stainless Steel	80	2	R-8.4 (1.48 RSI)	0.058 (0.33)	0.055 (0.31)	0.008 (0.004)
	160	5	R-21.0 (3.70 RSI)	0.040 (0.22)	0.038 (0.21)	0.005 (0.003)
	220	8	R-33.6 (5.92 RSI)	0.031 (0.18)	0.030 (0.17)	0.003 (0.002)

To illustrate the difference in the thermal performance of the FP bracket with and without the thermal isolator, the nominal vs. effective R-values for the two backup wall configurations are shown below in Figure 3.5.1 and 3.5.2.

¹² This value is the nominal R-value of the exterior insulation ONLY. Additional components, such as the sheathing, batt insulation, and air films all contribute an additional R-3.2 towards the nominal R-value of the entire assembly.

¹³ This value is the nominal R-value of the exterior insulation ONLY. Additional components, such as the sheathing, batt insulation, and air films all contribute an additional R-21.3 towards the nominal R-value of the entire assembly.



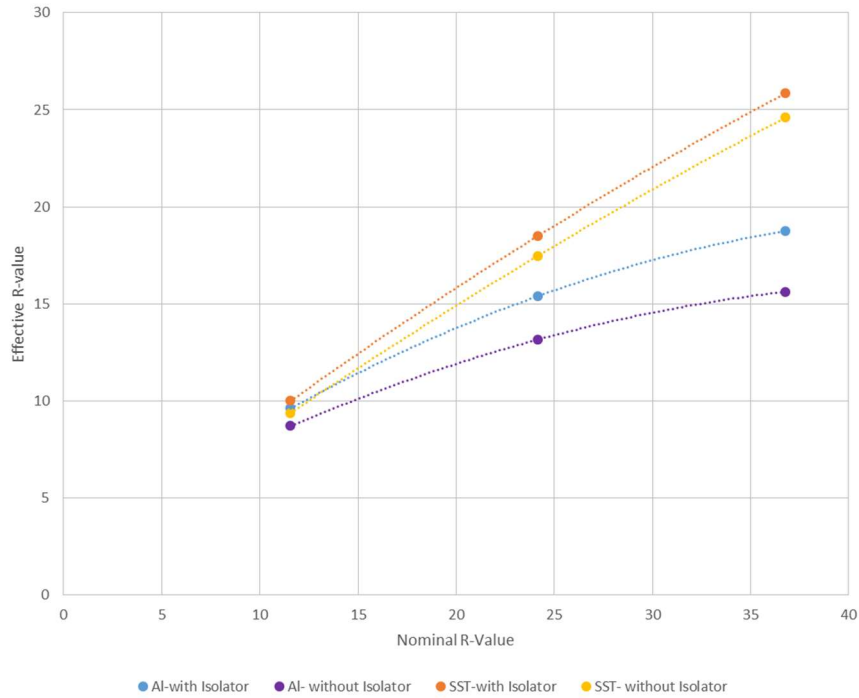

Figure 3.5.1: Nominal vs. Effective R-value of the FP Bracket with and without the Thermal Isolator Spaced 16" o.c. Horizontally and 24" o.c. Vertically, Exterior Insulated Steel Stud Assembly (Table D13)

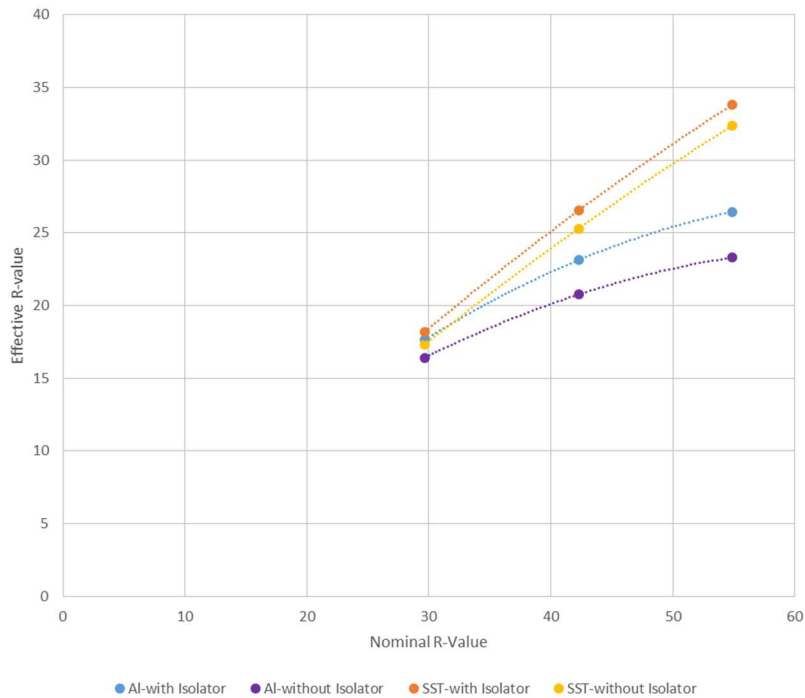

Figure 3.5.2: Nominal vs. Effective R-value of the FP Bracket with and without the Thermal Isolator Spaced 16" o.c. Horizontally and 24" o.c. Vertically, Split Insulated Steel Stud Assembly (Table D14)

Discussion

As is illustrated in Figure 3.5.1 and Figure 3.5.2, the thermal performance of the FP bracket with the thermal isolator is better than without the isolator, with the difference increasing with increasing exterior insulation thickness for both bracket materials. Of the two bracket materials, the aluminum bracket has a greater difference in performance than the stainless steel bracket. From Figure 3.5.1 and Figure 3.5.2, the largest difference in effective R-value for both bracket materials is with 8 inches exterior insulation (R-33.6), where the difference in the stainless steel effective R-value is R-1.4, and the aluminum effective R-value is R-3.1.

We believe that this report meets your objectives for evaluating the thermal performance for the StoVentec bracket system assemblies. If you have any questions or comments related to the above, please do not hesitate to contact the undersigned.

Morrison Hershfield Limited



Katie Hay, P.Eng.
Building Science Consultant

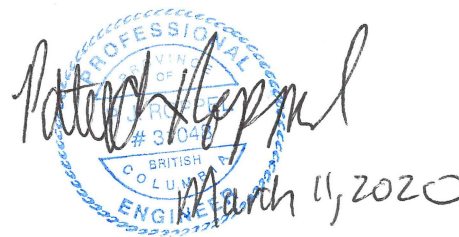

Patrick Roppel, P.Eng.
Principal, Building Science Consultant

APPENDIX A: DETAIL DRAWINGS

APPENDIX B: MODELLING PARAMETERS AND ASSUMPTIONS

1. GENERAL MODELLING APPROACH

For this report, a steady-state conduction model was used. The following parameters were also assumed:

- Material properties were taken from information provided by Sto Corporation and the ASHRAE Handbook – Fundamentals for common materials.
- Enclosed air spaces were modelled with an equivalent thermal conductivity of the air that includes the impacts of convection and radiation within the enclosure. Calculations for this equivalent conductivity were based on ISO 10077-2.
- Interior/exterior air films were taken from Table 1, p. 26.1 of 2009 ASHRAE Handbook – Fundamentals depending on surface orientation. The exterior air films were based on an exterior wind speed of 15 mph.
- In ASHRAE 1365-RP, for rain screen cavity systems, most lightweight claddings have an insignificant impact on the thermal performance other than shielding the insulation from direct wind exposure. The cladding and secondary structure outboard of the clip system were not explicitly modelled, but were incorporated into the exterior film coefficient.
- From the calibration in 1365-RP, contact resistances between materials were modeled and varied between R-0.01 and R-0.2 depending on the materials and interfaces.
- Insulation and other components were considered tight to adjacent interfaces.
- The clear field transmittances included in this analysis include uniform thermal bridges such as studs, brackets, and rails.

2. TEMPERATURE INDEX

The temperature index is the ratio of the surface temperature relative to the interior and exterior temperatures. The temperature index has a value between 0 and 1, where 0 is the exterior temperature and 1 is the interior temperature. If T_i is known, Equation 1 can be rearranged for $T_{surface}$. This arrangement allows the modelled surface temperatures to be applicable to any climate.

$$T_i = \frac{T_{surface} - T_{outside}}{T_{inside} - T_{outside}} \quad \text{EQ 1}$$

Note, these indices shown in the temperature profiles for this analysis are for general information only and are not intended to predict in-service surface temperatures subject to transient conditions, variable heating systems, and/ or interior obstructions that restrict heating of the assembly. For full limitations of this modeling approach, see ASHRAE 1365-RP.

3. BOUNDARY CONDITIONS

Table B3.1: Boundary Conditions

Boundary Location	Combined Convective and Radiation Heat Transfer Coefficient BTU/hff ² °F (W/m ² K)
Exterior Wall Surfaces with Generic Cladding	1.5 (8.3)
Interior Walls	1.5 (8.3)

4. U-VALUE CALCULATION FOR GP AND FP BRACKET ASSEMBLY

To illustrate how to calculate the U-value of a wall assembly with GP and FP brackets, let us consider the example assembly shown in Figure B4.1 below.

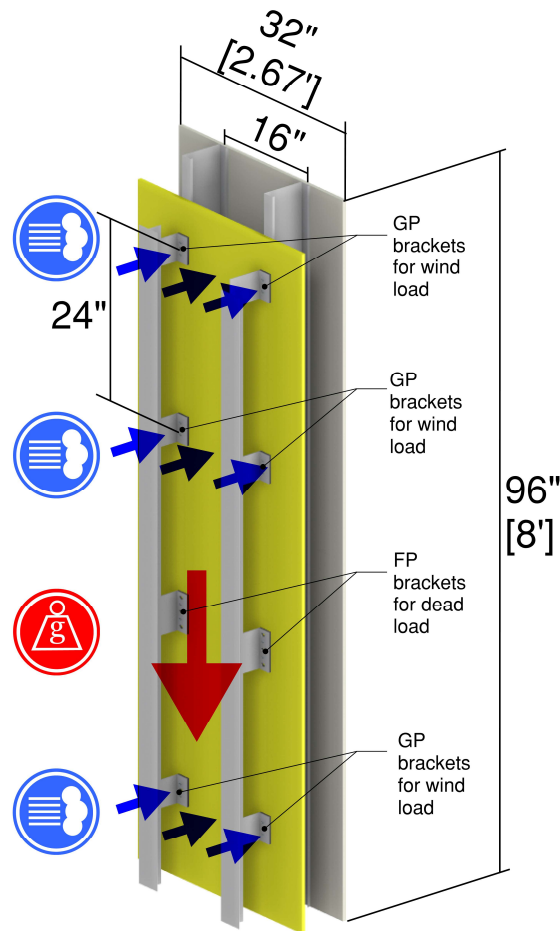

Figure B4.1: GP and FP Exterior Insulated Steel Stud Wall Assembly

The overall U-value for the wall assembly can be calculated using the following relationship:

$$\text{Total Heat flow per area through the overall assembly} = \frac{\text{Change in heat flow through FP point transmittances}}{\text{Total Area of assembly}} + \text{Heat flow per area through clear field GP assembly}$$

Or, in mathematical terms:

$$U_T = \frac{\Sigma(\Delta\chi_{FP})}{A_{Total}} + U_{o_GP} \quad \text{EQ 2}$$

Where:

- U_T = total effective assembly thermal transmittance (Btu/hr·ft²·°F or W/m²K)
 U_{o_GP} = clear field thermal transmittance (Btu/hr·ft²·°F or W/m²K)
 A_{total} = the total opaque wall area (ft² or m²)
 $\Delta\chi_{FP}$ = incremental heat flow from point thermal bridge (Btu/hr·°F or W/K)

For the assembly shown in Figure B4.1, assuming the assembly has 4 inches of exterior insulation, the equation 2 variables are as follows:

Variable	Value	Units	Reference
$\Delta\chi_{FP}$	0.013	Btu/hr °F	Table 3.1.2
# of $\Delta\chi_{FP}$	2	#	Figure B4.1
A_{total}	21.3	ft ²	Figure B4.1
U_{o_GP}	0.068	Btu/h ft ² °F	Table 3.1.1

Equation 2 can thus be solved as follows:

$$U_T = \frac{2 \times 0.013}{21.3} + 0.068 \text{ [Btu/h ft}^2 \text{ °F]} \quad \text{EQ 2}$$

$$U_T = 0.069 \text{ Btu/h ft}^2 \text{ °F}$$

APPENDIX C: MATERIAL PROPERTIES

1. EXTERIOR INSULATED STEEL STUD ASSEMBLY

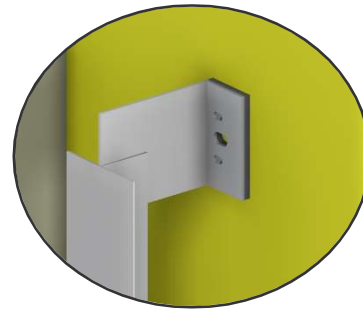
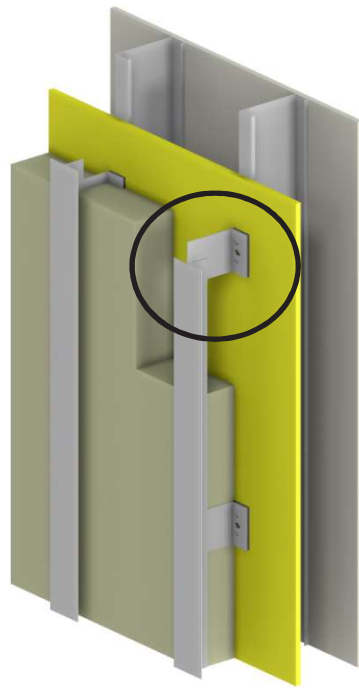

GP Bracket Detail

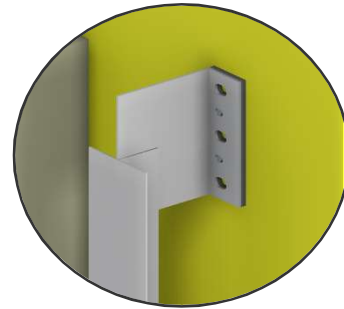

FP Bracket Detail

Component	Material	Thickness in (mm)	Thermal Conductivity Btu in / ft ² hr °F (W/m K)	Nominal Resistance ¹ ft ² hr °F / Btu (m ² K/W)
Interior Film	-	-	-	R-0.7 (0.12 RSI)
Gypsum	Gypsum	1/2 (13)	1.1 (0.16)	R-0.5 (0.08 RSI)
Stud Cavity	Air	6 (152)	6.7 (0.96)	R-0.9 (0.16 RSI)
Steel Stud	Galvanized Steel	18 ga.	430 (62)	-
Sheathing	Gypsum	1/2 (13)	1.1 (0.16)	R-0.5 (0.08 RSI)
Exterior Insulation	Mineral Wool	Varies	0.24 (0.034)	R-8.4 to R-33.6 (1.48 to 5.92 RSI)
Thermal Isolator	PVC	0.24 (6.0)	0.59 (0.085)	-
GP & FP Bracket: Size 80, 120, 160	Aluminum AW-6063	0.12 to 0.13 (3.0 to 3.2)	1457 (210)	-
GP & FP Bracket: Size 220	Aluminum AW-6063	0.16 to 0.17 (4.0 to 4.2)	1457 (210)	-
Fasteners	Steel	0.26 (6.5) Ø	347 (50)	-
Vertical T-Rail	Aluminum	0.08 (2.0)	1110 (160)	-
Air Spaces ²	Air	Varies	Varies	-
Exterior Film	-	-	-	R-0.7 (0.12 RSI)
Overall Wall Assembly 1D	-	-	-	R-11.6 to R-36.8 (2.04 to 6.48 RSI)

¹ Dash indicates not a continuous component

² The thermal conductivities of the air spaces were determined according to ISO 10077-2

2. SPLIT INSULATED STEEL STUD ASSEMBLY

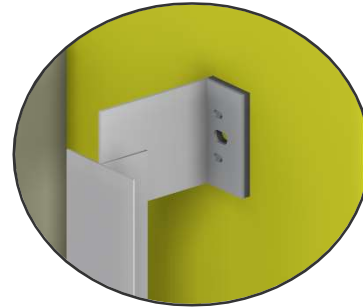
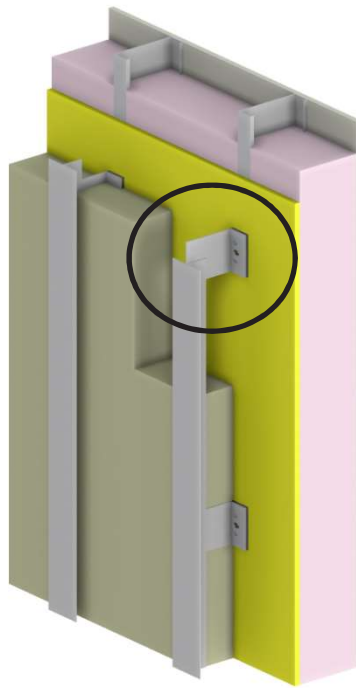

GP Bracket Detail

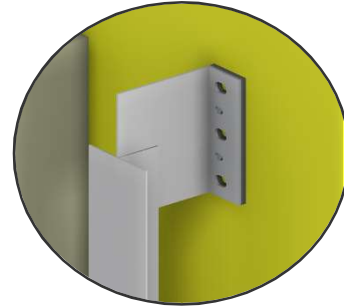

FP Bracket Detail

Component	Material	Thickness in (mm)	Thermal Conductivity Btu in / ft ² hr °F (W/m K)	Nominal Resistance ¹ ft ² hr °F / Btu (m ² K/W)
Interior Film	-	-	-	R-0.7 (0.12 RSI)
Gypsum	Gypsum	1/2 (13)	1.1 (0.16)	R-0.5 (0.08 RSI)
Stud Cavity	R-19 Batt Insulation	6 (152)	0.32 (0.046)	R-19.0 (3.35 RSI)
Steel Stud	Galvanized Steel	18 ga.	430 (62)	-
Sheathing	Gypsum	1/2 (13)	1.1 (0.16)	R-0.5 (0.08 RSI)
Exterior Insulation	Mineral Wool	Varies	0.24 (0.034)	R-8.4 to R-33.6 (1.48 to 5.92 RSI)
Thermal Isolator	PVC	0.24 (6.0)	0.59 (0.085)	-
GP & FP Bracket: Size 80, 120, 160	Aluminum AW- 6063	0.12 to 0.13 (3.0 to 3.2)	1457 (210)	-
GP & FP Bracket: Size 220	Aluminum AW- 6063	0.16 to 0.17 (4.0 to 4.2)	1457 (210)	-
Fasteners	Steel	0.26 (6.5) Ø	347 (50)	-
Vertical T-Rail	Aluminum	0.08 (2.0)	1110 (160)	-
Air Spaces ²	Air	Varies	Varies	-
Exterior Film	-	-	-	R-0.7 (0.12 RSI)
Overall Wall Assembly 1D	-	-	-	R-29.7 to R-54.9 (5.23 to 9.66 RSI)

¹ Dash indicates not a continuous component

² The thermal conductivities of the air spaces were determined according to ISO 10077-2

3. POURED-IN-PLACE CONCRETE ASSEMBLY

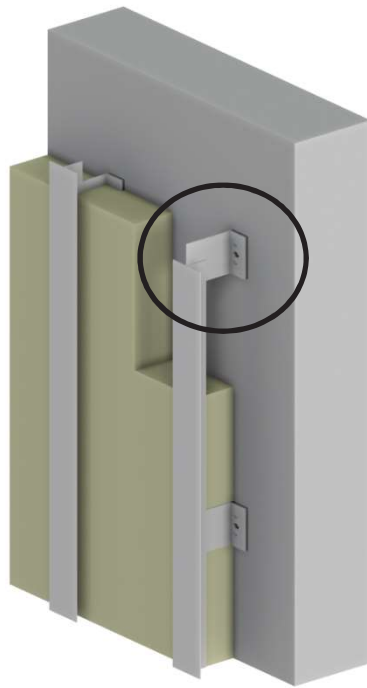

GP Bracket Detail

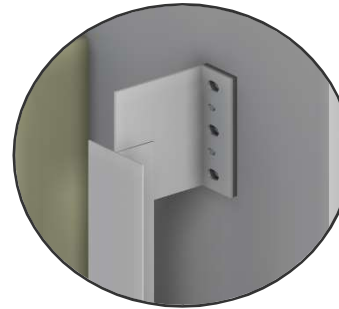

FP Bracket Detail

Component	Material	Thickness in (mm)	Thermal Conductivity Btu in / ft ² hr °F (W/m K)	Nominal Resistance ¹ ft ² hr °F / Btu (m ² K/W)
Interior Film	-	-	-	R-0.7 (0.12 RSI)
Poured-in-Place Concrete	Concrete	8 (203)	12.5 (1.80)	R-0.6 (0.11 RSI)
Exterior Insulation	Mineral Wool	Varies	0.24 (0.034)	R-8.4 to R-33.6 (1.48 to 5.92 RSI)
Thermal Isolator	PVC	0.24 (6.0)	0.59 (0.085)	-
GP & FP Bracket: Size 80, 120, 160	Aluminum AW-6063	0.12 to 0.13 (3.0 to 3.2)	1457 (210)	-
GP & FP Bracket: Size 220	Aluminum AW-6063	0.16 to 0.17 (4.0 to 4.2)	1457 (210)	-
Fasteners	Steel	0.26 (6.5) Ø	347 (50)	-
Vertical T-Rail	Aluminum	0.08 (2.0)	1110 (160)	-
Air Spaces ²	Air	Varies	Varies	-
Exterior Film	-	-	-	R-0.7 (0.12 RSI)
Overall Wall Assembly 1D	-	-	-	R-10.4 to R-35.6 (1.83 to 6.27 RSI)

¹ Dash indicates not a continuous component

² The thermal conductivities of the air spaces were determined according to ISO 10077-2

4. STAINLESS STEEL GP AND FP BRACKET ASSEMBLIES

4.1 GP and FP Bracket Assemblies with Exterior Insulated Steel Stud

Component	Material	Thickness in (mm)	Thermal Conductivity Btu in / ft ² hr °F (W/mK)	Nominal Resistance ¹ ft ² hr °F / Btu (m ² K/W)
Interior Film	-	-	-	R-0.7 (0.12 RSI)
Gypsum	Gypsum	1/2 (13)	1.1 (0.16)	R-0.5 (0.08 RSI)
Stud Cavity	Air	6 (152)	6.7 (0.96)	R-0.9 (0.16 RSI)
Steel Stud	Galvanized Steel	18 ga.	430 (62)	-
Sheathing	Gypsum	1/2 (13)	1.1 (0.16)	R-0.5 (0.08 RSI)
Exterior Insulation	Mineral Wool	Varies	0.24 (0.034)	R-8.4 to R-33.6 (1.48 to 5.92 RSI)
Thermal Isolator	PVC	0.24 (6.0)	0.59 (0.085)	-
GP Bracket	Stainless Steel	0.079 (2.0)	118 (17)	-
FP Bracket	Stainless Steel	0.098 (2.5)	118 (17)	-
Fasteners	Steel	0.26 (6.5) Ø	347 (50)	-
Vertical T-Rail	Aluminum	0.08 (2.0)	1110 (160)	-
Air Spaces ²	Air	Varies	Varies	-
Exterior Film	-	-	-	R-0.7 (0.12 RSI)
Overall Wall Assembly 1D	-	-	-	R-11.6 to R-36.8 (2.04 to 6.48 RSI)

¹ Dash indicates not a continuous component

² The thermal conductivities of the air spaces were determined according to ISO 10077-2

4.2 GP and FP Bracket Assemblies with Split Insulated Steel Stud

Component	Material	Thickness in (mm)	Thermal Conductivity Btu in / ft ² hr °F (W/m K)	Nominal Resistance ¹ ft ² hr °F / Btu (m ² K/W)
Interior Film	-	-	-	R-0.7 (0.12 RSI)
Gypsum	Gypsum	1/2 (13)	1.1 (0.16)	R-0.5 (0.08 RSI)
Stud Cavity	R-19 Batt Insulation	6 (152)	0.32 (0.046)	R-19.0 (3.35 RSI)
Steel Stud	Galvanized Steel	18 ga.	430 (62)	-
Sheathing	Gypsum	1/2 (13)	1.1 (0.16)	R-0.5 (0.08 RSI)
Exterior Insulation	Mineral Wool	Varies	0.24 (0.034)	R-8.4 to R-33.6 (1.48 to 5.92 RSI)
Thermal Isolator	PVC	0.24 (6.0)	0.59 (0.085)	-
GP Bracket	Stainless Steel	0.079 (2.0)	118 (17)	-
FP Bracket	Stainless Steel	0.098 (2.5)	118 (17)	-
Fasteners	Steel	0.26 (6.5) Ø	347 (50)	-
Vertical T-Rail	Aluminum	0.08 (2.0)	1110 (160)	-
Air Spaces ²	Air	Varies	Varies	-
Exterior Film	-	-	-	R-0.7 (0.12 RSI)
Overall Wall Assembly 1D	-	-	-	R-29.7 to R-54.9 (5.23 to 9.66 RSI)

¹ Dash indicates not a continuous component

² The thermal conductivities of the air spaces were determined according to ISO 10077-2

4.3 GP and FP Bracket Assemblies with Poured-in-Place Concrete

Component	Material	Thickness in (mm)	Thermal Conductivity Btu in / ft ² hr °F (W/m K)	Nominal Resistance ¹ ft ² hr °F / Btu (m ² K/W)
Interior Film	-	-	-	R-0.7 (0.12 RSI)
Poured-in-Place Concrete	Concrete	8 (203)	12.5 (1.80)	R-0.6 (0.11 RSI)
Exterior Insulation	Mineral Wool	Varies	0.24 (0.034)	R-8.4 to R-33.6 (1.48 to 5.92 RSI)
Thermal Isolator	PVC	0.24 (6.0)	0.59 (0.085)	-
GP Bracket	Stainless Steel	0.079 (2.0)	118 (17)	-
FP Bracket	Stainless Steel	0.098 (2.5)	118 (17)	-
Fasteners	Steel	0.26 (6.5) Ø	347 (50)	-
Vertical T-Rail	Aluminum	0.08 (2.0)	1110 (160)	-
Air Spaces ²	Air	Varies	Varies	-
Exterior Film	-	-	-	R-0.7 (0.12 RSI)
Overall Wall Assembly 1D	-	-	-	R-10.4 to R-35.6 (1.83 to 6.27 RSI)

¹ Dash indicates not a continuous component

² The thermal conductivities of the air spaces were determined according to ISO 10077-2

5. SENSITIVITY ANALYSIS: FP BRACKET WITH NO THERMAL BREAK

5.1 Aluminum and Stainless Steel FP Bracket with Exterior Insulated Steel Stud

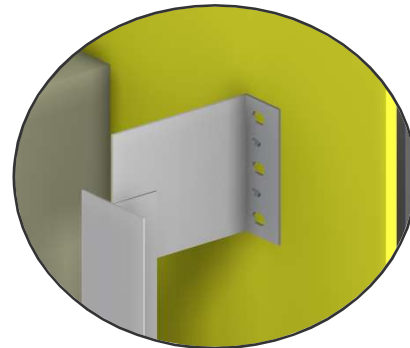
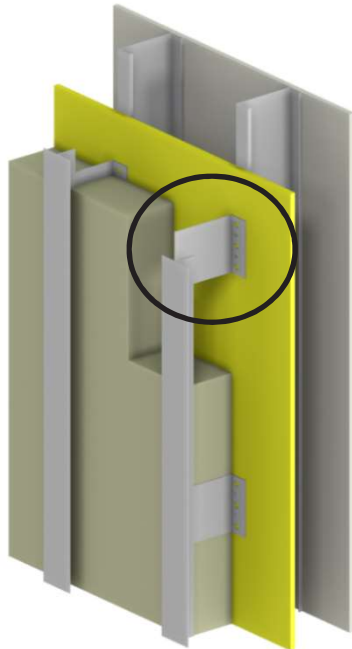

FP Bracket Detail

Component	Material	Thickness in (mm)	Thermal Conductivity Btu in / ft ² hr °F (W/m K)	Nominal Resistance ¹ ft ² hr °F / Btu (m ² K/W)
Interior Film	-	-	-	R-0.7 (0.12 RSI)
Gypsum	Gypsum	1/2 (13)	1.1 (0.16)	R-0.5 (0.08 RSI)
Stud Cavity	Air	6 (152)	6.7 (0.96)	R-0.9 (0.16 RSI)
Steel Stud	Galvanized Steel	18 ga.	430 (62)	-
Sheathing	Gypsum	1/2 (13)	1.1 (0.16)	R-0.5 (0.08 RSI)
Exterior Insulation	Mineral Wool	Varies	0.24 (0.034)	R-8.4 to R-33.6 (1.48 to 5.92 RSI)
FP Aluminum Bracket: Size 80, 160	Aluminum AW-6063	0.12 to 0.13 (3.0 to 3.2)	1457 (210)	-
FP Aluminum Bracket: Size 220	Aluminum AW-6063	0.16 to 0.17 (4.0 to 4.2)	1457 (210)	-
FP Stainless Steel Bracket	Stainless Steel	0.098 (2.5)	118 (17)	-
Fasteners	Steel	0.26 (6.5) Ø	347 (50)	-
Vertical T-Rail	Aluminum	0.08 (2.0)	1110 (160)	-
Air Spaces ²	Air	Varies	Varies	-
Exterior Film	-	-	-	R-0.7 (0.12 RSI)
Overall Wall Assembly 1D	-	-	-	R-11.6 to R-36.8 (2.04 to 6.48 RSI)

¹ Dash indicates not a continuous component

² The thermal conductivities of the air spaces were determined according to ISO 10077-2

5.2 Aluminum and Stainless Steel FP Bracket with Split Insulated Steel Stud

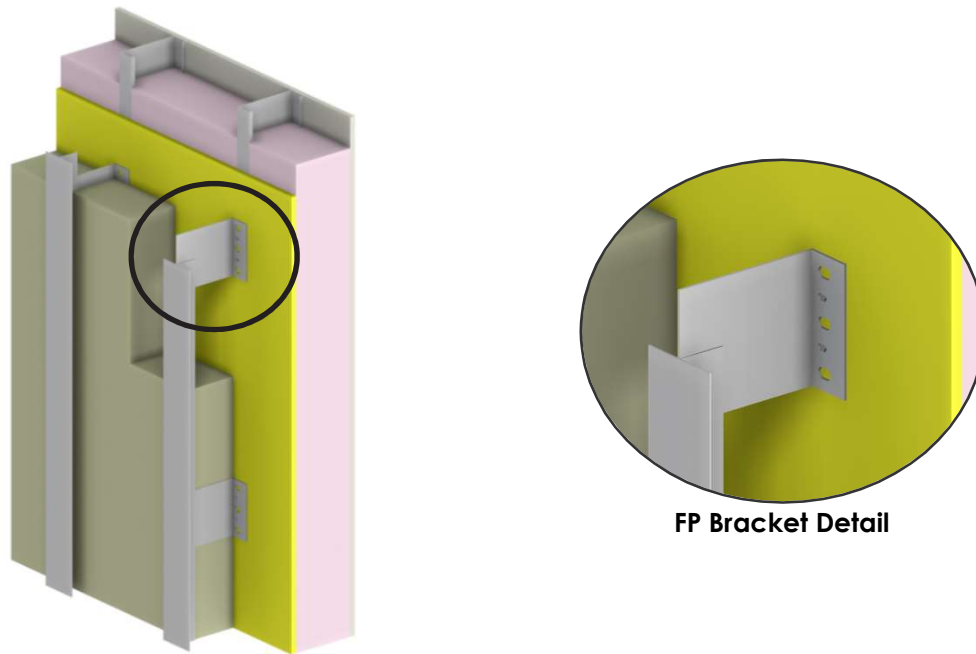

Component	Material	Thickness in (mm)	Thermal Conductivity Btu in / ft ² hr °F (W/m K)	Nominal Resistance ¹ ft ² hr °F / Btu (m ² K/W)
Interior Film	-	-	-	R-0.7 (0.12 RSI)
Gypsum	Gypsum	1/2 (13)	1.1 (0.16)	R-0.5 (0.08 RSI)
Stud Cavity	R-19 Batt Insulation	6 (152)	0.32 (0.046)	R-19.0 (3.35 RSI)
Steel Stud	Galvanized Steel	18 ga.	430 (62)	-
Sheathing	Gypsum	1/2 (13)	1.1 (0.16)	R-0.5 (0.08 RSI)
Exterior Insulation	Mineral Wool	Varies	0.24 (0.034)	R-8.4 to R-33.6 (1.48 to 5.92 RSI)
FP Aluminum Bracket: Size 80, 160	Aluminum AW-6063	0.12 to 0.13 (3.0 to 3.2)	1457 (210)	-
FP Aluminum Bracket: Size 220	Aluminum AW-6063	0.16 to 0.17 (4.0 to 4.2)	1457 (210)	-
FP Stainless Steel Bracket	Stainless Steel	0.098 (2.5)	118 (17)	-
Fasteners	Steel	0.26 (6.5) Ø	347 (50)	-
Vertical T-Rail	Aluminum	0.08 (2.0)	1110 (160)	-
Air Spaces ²	Air	Varies	Varies	-
Exterior Film	-	-	-	R-0.7 (0.12 RSI)
Overall Wall Assembly 1D	-	-	-	R-29.7 to R-54.9 (5.23 to 9.66 RSI)

¹ Dash indicates not a continuous component

² The thermal conductivities of the air spaces were determined according to ISO 10077-2

APPENDIX D: EFFECTIVE ASSEMBLY R-VALUES

Table D1: Effective R-Value for GP Bracket with Exterior Insulated Steel Stud Assemblies

Horizontal Bracket Spacing in	StoVentec Bracket Size	Exterior Insulation Thickness in	Exterior Insulation Nominal R-Value ¹ ft ² hr °F/Btu (m ² °K/W)	Effective R-Value ft ² hr °F/Btu (m ² °K/W)		
				24" Vertical Bracket Spacing	36" Vertical Bracket Spacing	48" Vertical Bracket Spacing
16	80	2	R-8.4 (1.48 RSI)	R-10.2 (1.79)	R-10.4 (1.83)	R-10.6 (1.87)
	120	4	R-16.8 (2.96 RSI)	R-14.7 (2.60)	R-16.0 (2.82)	R-16.8 (2.96)
	160	5	R-21.0 (3.70 RSI)	R-16.7 (2.94)	R-18.6 (3.27)	R-19.7 (3.47)
	220	8	R-33.6 (5.92 RSI)	R-20.9 (3.68)	R-24.3 (4.27)	R-26.4 (4.65)
32	80	2	R-8.4 (1.48 RSI)	R-10.7 (1.89)	R-11.0 (1.94)	R-11.2 (1.96)
	120	4	R-16.8 (2.96 RSI)	R-16.9 (2.98)	R-18.1 (3.19)	R-18.5 (3.26)
	160	5	R-21.0 (3.70 RSI)	R-19.7 (3.48)	R-21.3 (3.75)	R-21.9 (3.86)
	220	8	R-33.6 (5.92 RSI)	R-26.6 (4.68)	R-30.1 (5.30)	R-31.5 (5.54)

Table D2: Effective R-Value for FP Bracket with Exterior Insulated Steel Stud Assemblies

Horizontal Bracket Spacing in	StoVentec Bracket Size	Exterior Insulation Thickness in	Exterior Insulation Nominal R-Value ¹ ft ² hr °F/Btu (m ² °K/W)	Effective R-Value ft ² hr °F/Btu (m ² °K/W)		
				24" Vertical Bracket Spacing	36" Vertical Bracket Spacing	48" Vertical Bracket Spacing
16	80	2	R-8.4 (1.48 RSI)	R-9.6 (1.69)	R-10.1 (1.78)	R-10.4 (1.84)
	120	4	R-16.8 (2.96 RSI)	R-13.8 (2.43)	R-15.2 (2.69)	R-16.1 (2.84)
	160	5	R-21.0 (3.70 RSI)	R-15.4 (2.71)	R-17.4 (3.07)	R-18.7 (3.30)
	220	8	R-33.6 (5.92 RSI)	R-18.7 (3.30)	R-22.2 (3.91)	R-24.6 (4.33)
32	80	2	R-8.4 (1.48 RSI)	R-10.5 (1.85)	R-10.8 (1.90)	R-11.0 (1.93)
	120	4	R-16.8 (2.96 RSI)	R-16.3 (2.87)	R-17.3 (3.04)	R-17.8 (3.14)
	160	5	R-21.0 (3.70 RSI)	R-18.8 (3.31)	R-20.2 (3.56)	R-21.1 (3.71)
	220	8	R-33.6 (5.92 RSI)	R-24.8 (4.36)	R-27.6 (4.87)	R-29.4 (5.18)

¹ This value is the nominal R-value of the exterior insulation ONLY. Additional components, such as the sheathing, batt insulation, and air films all contribute an additional R-3.2 towards the nominal R-value of the entire assembly.



Table D3: Effective R-Value for GP Bracket with Split Insulated Steel Stud Assemblies

Horizontal Bracket Spacing in	StoVentec Bracket Size	Exterior Insulation Thickness in	Exterior Insulation Nominal R-Value ² ft ² hr °F/Btu (m ² °K/W)	Effective R-Value ft ² hr °F/Btu (m ² °K/W)		
				24" Vertical Bracket Spacing	36" Vertical Bracket Spacing	48" Vertical Bracket Spacing
16	80	2	R-8.4 (1.48 RSI)	R-18.5 (3.25)	R-18.9 (3.33)	R-19.3 (3.40)
	120	4	R-16.8 (2.96 RSI)	R-22.7 (4.00)	R-24.4 (4.29)	R-25.3 (4.46)
	160	5	R-21.0 (3.70 RSI)	R-24.6 (4.33)	R-26.9 (4.73)	R-28.2 (4.97)
	220	8	R-33.6 (5.92 RSI)	R-28.7 (5.06)	R-32.5 (5.73)	R-35.0 (6.17)
32	80	2	R-8.4 (1.48 RSI)	R-19.4 (3.42)	R-19.9 (3.51)	R-20.1 (3.54)
	120	4	R-16.8 (2.96 RSI)	R-25.6 (4.50)	R-26.9 (4.74)	R-27.4 (4.83)
	160	5	R-21.0 (3.70 RSI)	R-28.4 (4.99)	R-30.1 (5.30)	R-30.8 (5.43)
	220	8	R-33.6 (5.92 RSI)	R-35.3 (6.22)	R-39.0 (6.87)	R-40.5 (7.13)

Table D4: Effective R-Value for FP Bracket with Split Insulated Steel Stud Assemblies

Horizontal Bracket Spacing in	StoVentec Bracket Size	Exterior Insulation Thickness in	Exterior Insulation Nominal R-Value ² ft ² hr °F/Btu (m ² °K/W)	Effective R-Value ft ² hr °F/Btu (m ² °K/W)		
				24" Vertical Bracket Spacing	36" Vertical Bracket Spacing	48" Vertical Bracket Spacing
16	80	2	R-8.4 (1.48 RSI)	R-17.7 (3.11)	R-18.5 (3.26)	R-19.0 (3.34)
	120	4	R-16.8 (2.96 RSI)	R-21.6 (3.80)	R-23.4 (4.13)	R-24.6 (4.33)
	160	5	R-21.0 (3.70 RSI)	R-23.1 (4.07)	R-25.6 (4.51)	R-27.2 (4.79)
	220	8	R-33.6 (5.92 RSI)	R-26.4 (4.66)	R-30.4 (5.36)	R-33.2 (5.84)
32	80	2	R-8.4 (1.48 RSI)	R-19.1 (3.37)	R-19.6 (3.45)	R-19.9 (3.50)
	120	4	R-16.8 (2.96 RSI)	R-24.8 (4.38)	R-26.0 (4.59)	R-26.7 (4.71)
	160	5	R-21.0 (3.70 RSI)	R-27.4 (4.82)	R-29.0 (5.11)	R-30.0 (5.29)
	220	8	R-33.6 (5.92 RSI)	R-33.5 (5.91)	R-36.6 (6.45)	R-38.5 (6.79)

² This value is the nominal R-value of the exterior insulation ONLY. Additional components, such as the sheathing, batt insulation, and air films all contribute an additional R-21.3 towards the nominal R-value of the entire assembly.

Table D5: Effective R-Value for GP Bracket with Poured-in-Place Concrete Assemblies

Horizontal Bracket Spacing in	StoVentec Bracket Size	Exterior Insulation Thickness in	Exterior Insulation Nominal R-Value ³ ft ² hr °F/Btu (m ² °K/W)	Effective R-Value ft ² hr °F/Btu (m ² °K/W)		
				24" Vertical Bracket Spacing	36" Vertical Bracket Spacing	48" Vertical Bracket Spacing
16	80	2	R-8.4 (1.48 RSI)	R-8.7 (1.54)	R-9.0 (1.59)	R-9.3 (1.64)
	120	4	R-16.8 (2.96 RSI)	R-12.7 (2.23)	R-14.1 (2.48)	R-15.0 (2.64)
	160	5	R-21.0 (3.70 RSI)	R-14.3 (2.52)	R-16.3 (2.88)	R-17.6 (3.10)
	220	8	R-33.6 (5.92 RSI)	R-17.8 (3.13)	R-21.2 (3.73)	R-23.5 (4.14)
32	80	2	R-8.4 (1.48 RSI)	R-9.4 (1.65)	R-9.8 (1.72)	R-9.9 (1.75)
	120	4	R-16.8 (2.96 RSI)	R-15.1 (2.66)	R-16.6 (2.92)	R-17.1 (3.00)
	160	5	R-21.0 (3.70 RSI)	R-17.6 (3.11)	R-19.5 (3.43)	R-20.3 (3.57)
	220	8	R-33.6 (5.92 RSI)	R-23.6 (4.16)	R-27.7 (4.89)	R-29.3 (5.16)

Table D6: Effective R-Value for FP Bracket with Poured-in-Place Concrete Assemblies

Horizontal Bracket Spacing (in)	StoVentec Bracket Size	Exterior Insulation Thickness (in)	Exterior Insulation Nominal R-Value ³ ft ² hr °F/Btu (m ² °K/W)	Effective R-Value ft ² hr °F/Btu (m ² °K/W)		
				24" Vertical Bracket Spacing	36" Vertical Bracket Spacing	48" Vertical Bracket Spacing
16	80	2	R-8.4 (1.48 RSI)	R-8.0 (1.42)	R-8.7 (1.53)	R-9.0 (1.59)
	120	4	R-16.8 (2.96 RSI)	R-11.6 (2.04)	R-13.2 (2.32)	R-14.2 (2.49)
	160	5	R-21.0 (3.70 RSI)	R-12.9 (2.27)	R-15.0 (2.64)	R-16.4 (2.89)
	220	8	R-33.6 (5.92 RSI)	R-15.5 (2.74)	R-18.9 (3.34)	R-21.4 (3.76)
32	80	2	R-8.4 (1.48 RSI)	R-9.1 (1.60)	R-9.5 (1.67)	R-9.7 (1.71)
	120	4	R-16.8 (2.96 RSI)	R-14.3 (2.52)	R-15.5 (2.72)	R-16.2 (2.85)
	160	5	R-21.0 (3.70 RSI)	R-16.5 (2.90)	R-18.1 (3.19)	R-19.2 (3.37)
	220	8	R-33.6 (5.92 RSI)	R-21.5 (3.79)	R-24.7 (4.34)	R-26.7 (4.70)

³ This value is the nominal R-value of the exterior insulation ONLY. Additional components, such as the sheathing, batt insulation, and air films all contribute an additional R-2.0 towards the nominal R-value of the entire assembly.



Table D7: Effective R-Value for Aluminum vs. Stainless Steel GP Bracket for 16" o.c.
Horizontal Bracket Spacing, Exterior Insulated Steel Stud

Vertical Bracket Spacing in	StoVentec Bracket Size	Exterior Insulation Thickness in	Exterior Insulation Nominal R-Value ⁴ ft ² hr °F/Btu (m ² °K/W)	Effective R-Value ft ² hr °F/Btu (m ² °K/W)		Difference in R-Value ft ² hr °F/Btu (m ² °K/W)
				Aluminum Bracket	Stainless Steel Bracket	
24	80	2	R-8.4 (1.48 RSI)	R-10.2 (1.79)	R-10.4 (1.82)	R-0.2 (0.04)
	120	4	R-16.8 (2.96 RSI)	R-14.7 (2.60)	R-16.6 (2.92)	R-1.8 (0.32)
	160	5	R-21.0 (3.70 RSI)	R-16.7 (2.94)	R-20.1 (3.54)	R-3.4 (0.59)
	220	8	R-33.6 (5.92 RSI)	R-20.9 (3.68)	R-28.8 (5.08)	R-7.9 (1.40)
48	80	2	R-8.4 (1.48 RSI)	R-10.6 (1.87)	R-10.9 (1.91)	R-0.2 (0.04)
	120	4	R-16.8 (2.96 RSI)	R-16.8 (2.96)	R-17.9 (3.16)	R-1.1 (0.20)
	160	5	R-21.0 (3.70 RSI)	R-19.7 (3.47)	R-21.9 (3.86)	R-2.2 (0.39)
	220	8	R-33.6 (5.92 RSI)	R-26.4 (4.65)	R-32.1 (5.66)	R-5.7 (1.00)

Table D8: Effective R-Value for Aluminum vs. Stainless Steel FP Bracket for 16" o.c.
Horizontal Bracket Spacing, Exterior Insulated Steel Stud

Vertical Bracket Spacing in	StoVentec Bracket Size	Exterior Insulation Thickness in	Exterior Insulation Nominal R-Value ⁴ ft ² hr °F/Btu (m ² °K/W)	Effective R-Value ft ² hr °F/Btu (m ² °K/W)		Difference in R-Value ft ² hr °F/Btu (m ² °K/W)
				Aluminum Bracket	Stainless Steel Bracket	
24	80	2	R-8.4 (1.48 RSI)	R-9.6 (1.69)	R-10.0 (1.76)	R-0.4 (0.07)
	120	4	R-16.8 (2.96 RSI)	R-13.8 (2.43)	R-15.5 (2.73)	R-1.7 (0.30)
	160	5	R-21.0 (3.70 RSI)	R-15.4 (2.71)	R-18.5 (3.26)	R-3.1 (0.55)
	220	8	R-33.6 (5.92 RSI)	R-18.7 (3.30)	R-25.8 (4.55)	R-7.1 (1.25)
48	80	2	R-8.4 (1.48 RSI)	R-10.4 (1.84)	R-10.7 (1.88)	R-0.2 (0.04)
	120	4	R-16.8 (2.96 RSI)	R-16.1 (2.84)	R-17.3 (3.04)	R-1.1 (0.20)
	160	5	R-21.0 (3.70 RSI)	R-18.7 (3.30)	R-20.9 (3.68)	R-2.2 (0.39)
	220	8	R-33.6 (5.92 RSI)	R-24.6 (4.33)	R-30.2 (5.31)	R-5.6 (0.98)

⁴ This value is the nominal R-value of the exterior insulation ONLY. Additional components, such as the sheathing, batt insulation, and air films all contribute an additional R-3.2 towards the nominal R-value of the entire assembly.



Table D9: Effective R-Value for Aluminum vs. Stainless Steel GP Bracket for 16" o.c.
Horizontal Bracket Spacing, Split Insulated Steel Stud

Vertical Bracket Spacing in	StoVentec Bracket Size	Exterior Insulation Thickness in	Exterior Insulation Nominal R-Value ⁵ ft ² hr °F/Btu (m ² °K/W)	Effective R-Value ft ² hr °F/Btu (m ² °K/W)		Difference in R-Value ft ² hr °F/Btu (m ² °K/W)
				Aluminum Bracket	Stainless Steel Bracket	
24	80	2	R-8.4 (1.48 RSI)	R-18.5 (3.25)	R-18.8 (3.30)	R-0.3 (0.05)
	120	4	R-16.8 (2.96 RSI)	R-22.7 (4.00)	R-24.8 (4.37)	R-2.1 (0.38)
	160	5	R-21.0 (3.70 RSI)	R-24.6 (4.33)	R-28.4 (5.00)	R-3.8 (0.67)
	220	8	R-33.6 (5.92 RSI)	R-28.7 (5.06)	R-37.1 (6.53)	R-8.3 (1.47)
48	80	2	R-8.4 (1.48 RSI)	R-19.3 (3.40)	R-19.6 (3.46)	R-0.3 (0.06)
	120	4	R-16.8 (2.96 RSI)	R-25.3 (4.46)	R-26.7 (4.69)	R-1.3 (0.24)
	160	5	R-21.0 (3.70 RSI)	R-28.2 (4.97)	R-30.7 (5.40)	R-2.4 (0.43)
	220	8	R-33.6 (5.92 RSI)	R-35.0 (6.17)	R-40.9 (7.20)	R-5.9 (1.03)

Table D10: Effective R-Value for Aluminum vs. Stainless Steel FP Bracket for 16" o.c.
Horizontal Bracket Spacing, Split Insulated Steel Stud

Vertical Bracket Spacing in	StoVentec Bracket Size	Exterior Insulation Thickness in	Exterior Insulation Nominal R-Value ⁵ ft ² hr °F/Btu (m ² °K/W)	Effective R-Value ft ² hr °F/Btu (m ² °K/W)		Difference in R-Value ft ² hr °F/Btu (m ² °K/W)
				Aluminum Bracket	Stainless Steel Bracket	
24	80	2	R-8.4 (1.48 RSI)	R-17.7 (3.11)	R-18.2 (3.20)	R-0.5 (0.09)
	120	4	R-16.8 (2.96 RSI)	R-21.6 (3.80)	R-23.5 (4.14)	R-1.9 (0.34)
	160	5	R-21.0 (3.70 RSI)	R-23.1 (4.07)	R-26.5 (4.67)	R-3.4 (0.60)
	220	8	R-33.6 (5.92 RSI)	R-26.4 (4.66)	R-33.8 (5.95)	R-7.4 (1.29)
48	80	2	R-8.4 (1.48 RSI)	R-19.0 (3.34)	R-19.3 (3.40)	R-0.3 (0.06)
	120	4	R-16.8 (2.96 RSI)	R-24.6 (4.33)	R-25.8 (4.55)	R-1.3 (0.22)
	160	5	R-21.0 (3.70 RSI)	R-27.2 (4.79)	R-29.5 (5.20)	R-2.3 (0.41)
	220	8	R-33.6 (5.92 RSI)	R-33.2 (5.84)	R-38.7 (6.82)	R-5.6 (0.98)

⁵ This value is the nominal R-value of the exterior insulation ONLY. Additional components, such as the sheathing, batt insulation, and air films all contribute an additional R-21.3 towards the nominal R-value of the entire assembly.



Table D11: Effective R-Value for Aluminum vs. Stainless Steel GP Bracket for 16" o.c. Horizontal Bracket Spacing, Poured-in-Place Concrete

Vertical Bracket Spacing in	StoVentec Bracket Size	Exterior Insulation Thickness in	Exterior Insulation Nominal R-Value ⁶ ft ² hr °F/Btu (m ² °K/W)	Effective R-Value ft ² hr °F/Btu (m ² °K/W)		Difference in R-Value ft ² hr °F/Btu (m ² °K/W)
				Aluminum Bracket	Stainless Steel Bracket	
24	80	2	R-8.4 (1.48 RSI)	R-8.7 (1.54)	R-9.1 (1.60)	R-0.3 (0.06)
	120	4	R-16.8 (2.96 RSI)	R-12.7 (2.23)	R-15.1 (2.66)	R-2.4 (0.43)
	160	5	R-21.0 (3.70 RSI)	R-14.3 (2.52)	R-18.6 (3.28)	R-4.3 (0.76)
	220	8	R-33.6 (5.92 RSI)	R-17.8 (3.13)	R-27.3 (4.81)	R-9.5 (1.68)
48	80	2	R-8.4 (1.48 RSI)	R-9.3 (1.64)	R-9.7 (1.70)	R-0.4 (0.06)
	120	4	R-16.8 (2.96 RSI)	R-15.0 (2.64)	R-16.6 (2.92)	R-1.6 (0.29)
	160	5	R-21.0 (3.70 RSI)	R-17.6 (3.10)	R-20.6 (3.62)	R-3.0 (0.52)
	220	8	R-33.6 (5.92 RSI)	R-23.5 (4.14)	R-30.7 (5.41)	R-7.2 (1.28)

Table D12: Effective R-Value for Aluminum vs. Stainless Steel FP Bracket for 16" o.c. Horizontal Bracket Spacing, Poured-in-Place Concrete

Vertical Bracket Spacing in	StoVentec Bracket Size	Exterior Insulation Thickness in	Exterior Insulation Nominal R-Value ⁶ ft ² hr °F/Btu (m ² °K/W)	Effective R-Value ft ² hr °F/Btu (m ² °K/W)		Difference in R-Value ft ² hr °F/Btu (m ² °K/W)
				Aluminum Bracket	Stainless Steel Bracket	
24	80	2	R-8.4 (1.48 RSI)	R-8.0 (1.42)	R-8.6 (1.52)	R-0.6 (0.10)
	120	4	R-16.8 (2.96 RSI)	R-11.6 (2.04)	R-13.9 (2.44)	R-2.3 (0.40)
	160	5	R-21.0 (3.70 RSI)	R-12.9 (2.27)	R-16.8 (2.97)	R-4.0 (0.70)
	220	8	R-33.6 (5.92 RSI)	R-15.5 (2.74)	R-24.0 (4.23)	R-8.5 (1.50)
48	80	2	R-8.4 (1.48 RSI)	R-9.0 (1.59)	R-9.4 (1.65)	R-0.4 (0.06)
	120	4	R-16.8 (2.96 RSI)	R-14.2 (2.49)	R-15.8 (2.78)	R-1.6 (0.29)
	160	5	R-21.0 (3.70 RSI)	R-16.4 (2.89)	R-19.4 (3.42)	R-3.0 (0.53)
	220	8	R-33.6 (5.92 RSI)	R-21.4 (3.76)	R-28.5 (5.03)	R-7.2 (1.26)

⁶ This value is the nominal R-value of the exterior insulation ONLY. Additional components, such as the sheathing, batt insulation, and air films all contribute an additional R-2.0 towards the nominal R-value of the entire assembly.



Table D13: Effective R-Value for FP Bracket for 16" o.c. x 24" o.c. Bracket Spacing, with and without the Thermal Isolator, Exterior Insulated Steel Stud Assembly

Bracket Material	StoVentec Bracket Size	Exterior Insulation Thickness in	Exterior Insulation Nominal R-Value ⁷ ft ² hr °F/Btu (m ² °K/W)	Effective R-Value ft ² hr °F/Btu (m ² °K/W)		Difference in R-Value ft ² hr °F/Btu (m ² °K/W)
				Without Thermal Isolator	With Thermal Isolator	
Aluminum	80	2	R-8.4 (1.48 RSI)	R-8.7 (1.53)	R-9.6 (1.69)	R-0.9 (0.16)
	160	5	R-21.0 (3.70 RSI)	R-13.2 (2.32)	R-15.4 (2.71)	R-2.2 (0.39)
	220	8	R-33.6 (5.92 RSI)	R-15.6 (2.75)	R-18.7 (3.30)	R-3.1 (0.55)
Stainless Steel	80	2	R-8.4 (1.48 RSI)	R-9.4 (1.65)	R-10.0 (1.76)	R-0.6 (0.11)
	160	5	R-21.0 (3.70 RSI)	R-17.5 (3.08)	R-18.5 (3.26)	R-1.0 (0.18)
	220	8	R-33.6 (5.92 RSI)	R-24.6 (4.33)	R-25.8 (4.55)	R-1.3 (0.22)

Table D14: Effective R-Value for FP Bracket for 16" o.c. x 24" o.c. Bracket Spacing, with and without the Thermal Isolator, Split Insulated Steel Stud Assembly

Bracket Material	StoVentec Bracket Size	Exterior Insulation Thickness in	Exterior Insulation Nominal R-Value ⁸ ft ² hr °F/Btu (m ² °K/W)	Effective R-Value ft ² hr °F/Btu (m ² °K/W)		Difference in R-Value ft ² hr °F/Btu (m ² °K/W)
				Without Thermal Isolator	With Thermal Isolator	
Aluminum	80	2	R-8.4 (1.48 RSI)	R-16.4 (2.89)	R-17.7 (3.11)	R-1.2 (0.22)
	160	5	R-21.0 (3.70 RSI)	R-20.8 (3.66)	R-23.1 (4.07)	R-2.4 (0.42)
	220	8	R-33.6 (5.92 RSI)	R-23.3 (4.11)	R-26.4 (4.66)	R-3.1 (0.55)
Stainless Steel	80	2	R-8.4 (1.48 RSI)	R-17.3 (3.05)	R-18.2 (3.20)	R-0.9 (0.16)
	160	5	R-21.0 (3.70 RSI)	R-25.3 (4.46)	R-26.5 (4.67)	R-1.2 (0.22)
	220	8	R-33.6 (5.92 RSI)	R-32.4 (5.70)	R-33.8 (5.95)	R-1.4 (0.25)

⁷ This value is the nominal R-value of the exterior insulation ONLY. Additional components, such as the sheathing, batt insulation, and air films all contribute an additional R-3.2 towards the nominal R-value of the entire assembly.

⁸ This value is the nominal R-value of the exterior insulation ONLY. Additional components, such as the sheathing, batt insulation, and air films all contribute an additional R-21.3 towards the nominal R-value of the entire assembly.



APPENDIX E: SIMULATED TEMPERATURE PROFILES

As an example of the thermal profiles of the Sto Bracket system, the following figures illustrate a typical temperature distribution for the 160 GP Bracket with 5 inches of exterior insulation (R-21) with 16 inches o.c. horizontal and 24 inches o.c. vertical bracket spacing. For the sensitivity analysis investigating the impact of the thermal isolator, the 160 FP bracket temperature distributions are presented. The profiles are presented as a temperature index (between 0 and 1). See Appendix B.2 for more information.

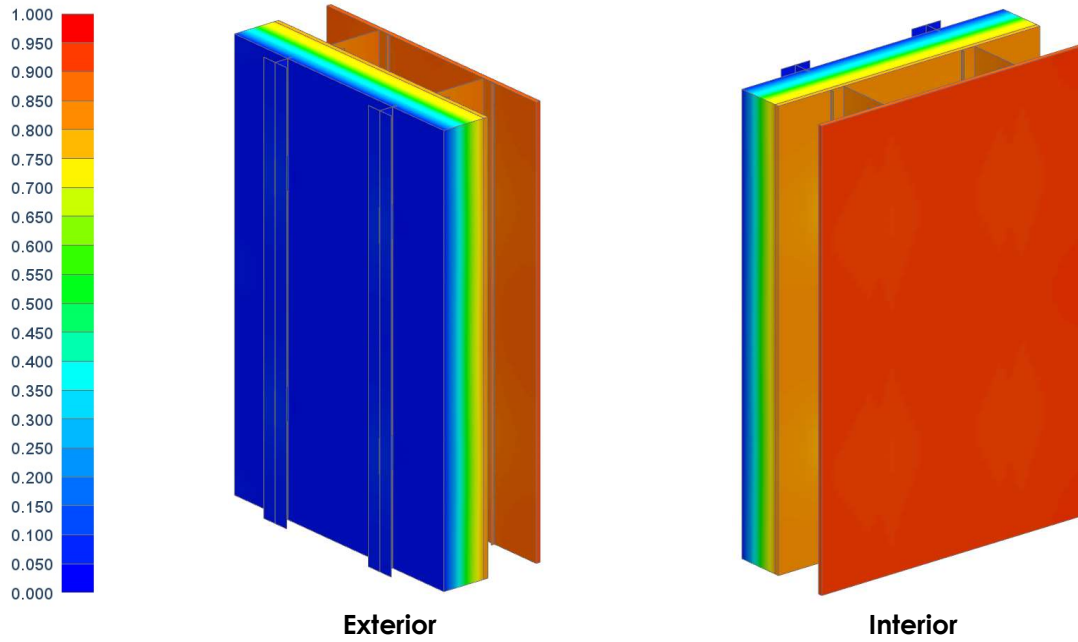

Figure E1: Temperature Profile 160 GP Bracket with Exterior Insulated Steel Stud

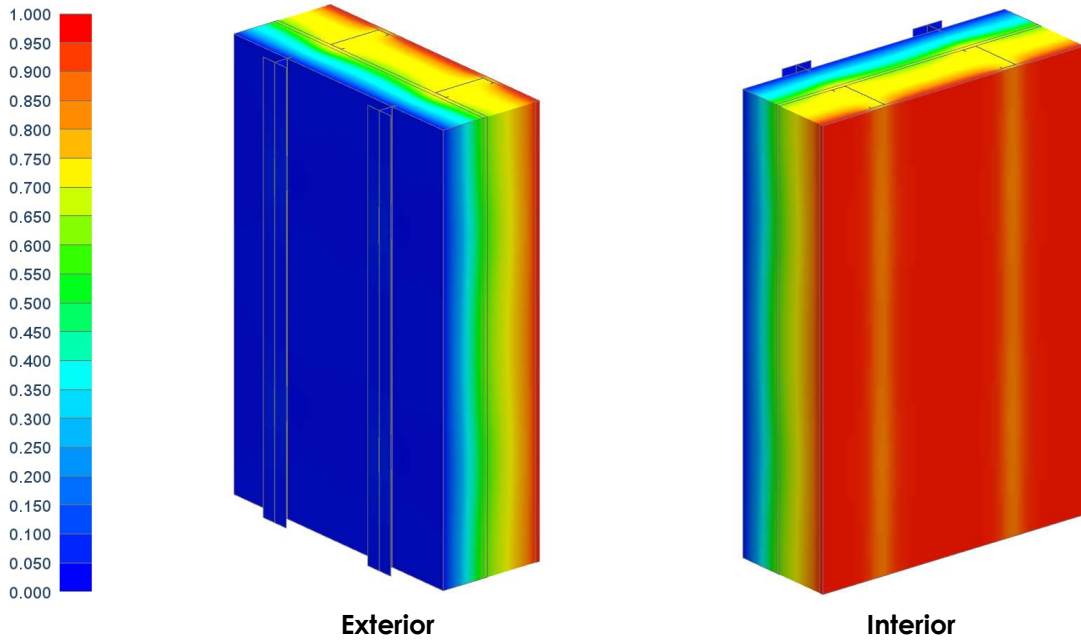

Figure E2: Temperature Profile of 160 GP Bracket with Split Insulated Steel Stud

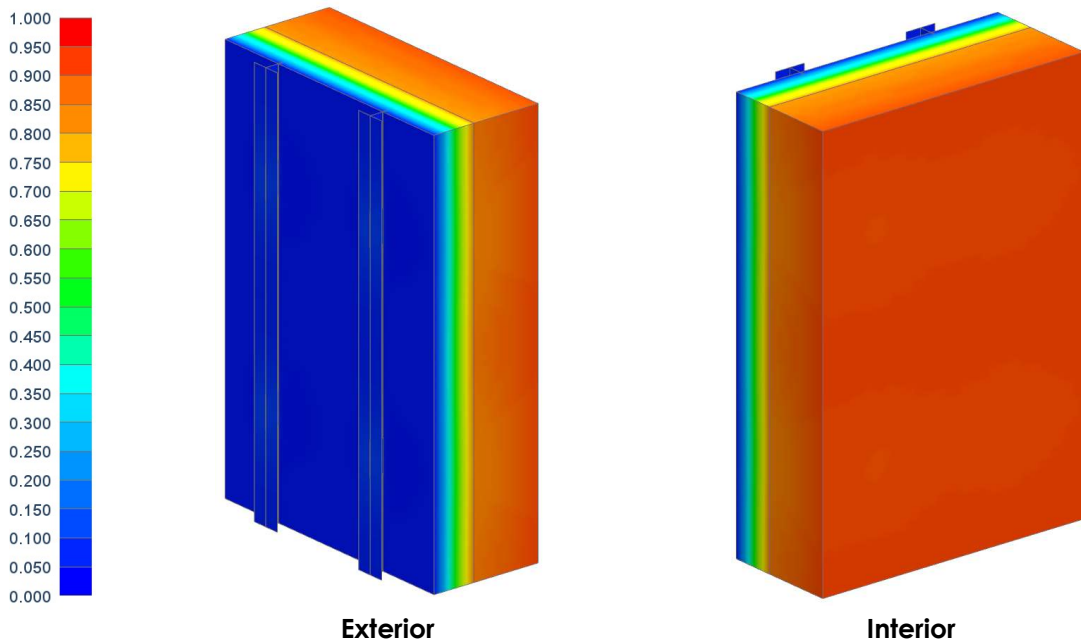

Figure E3: Temperature Profile of 160 GP Bracket with Poured-in-Place Concrete

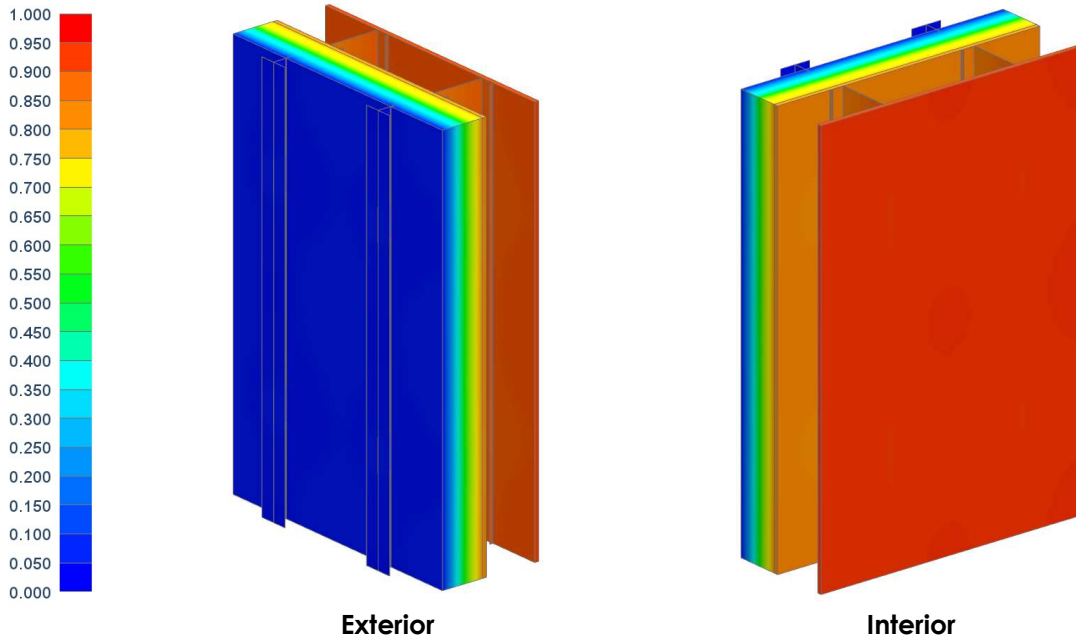

Figure E4: Temperature Profile of Stainless Steel 160 GP Bracket with Exterior Insulated Steel Stud

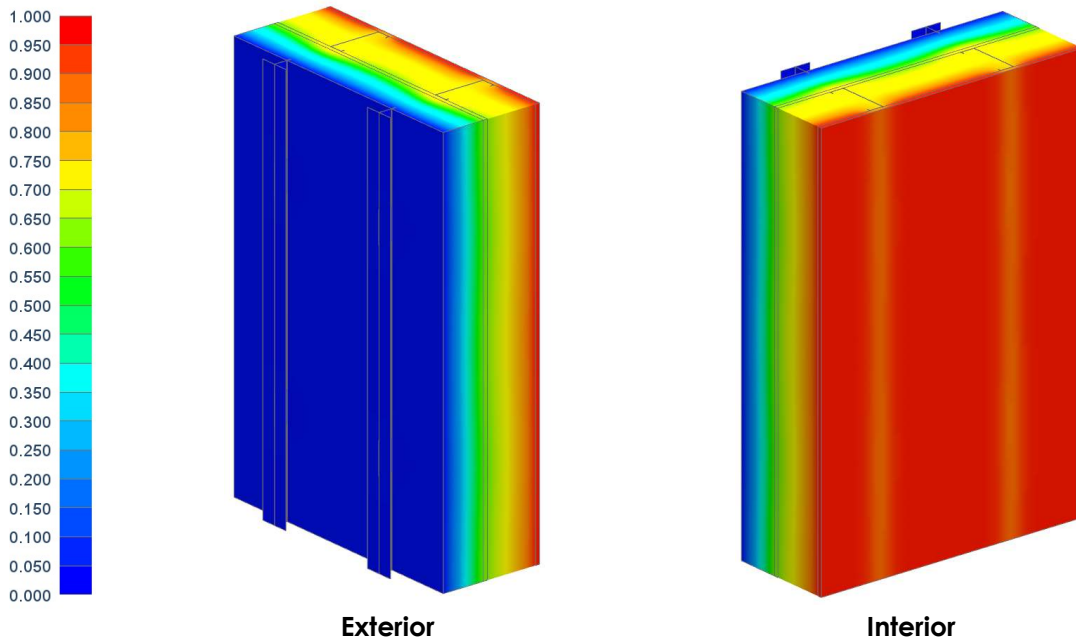

Figure E5: Temperature Profile Stainless Steel 160 GP Bracket with Split Insulated Steel Stud

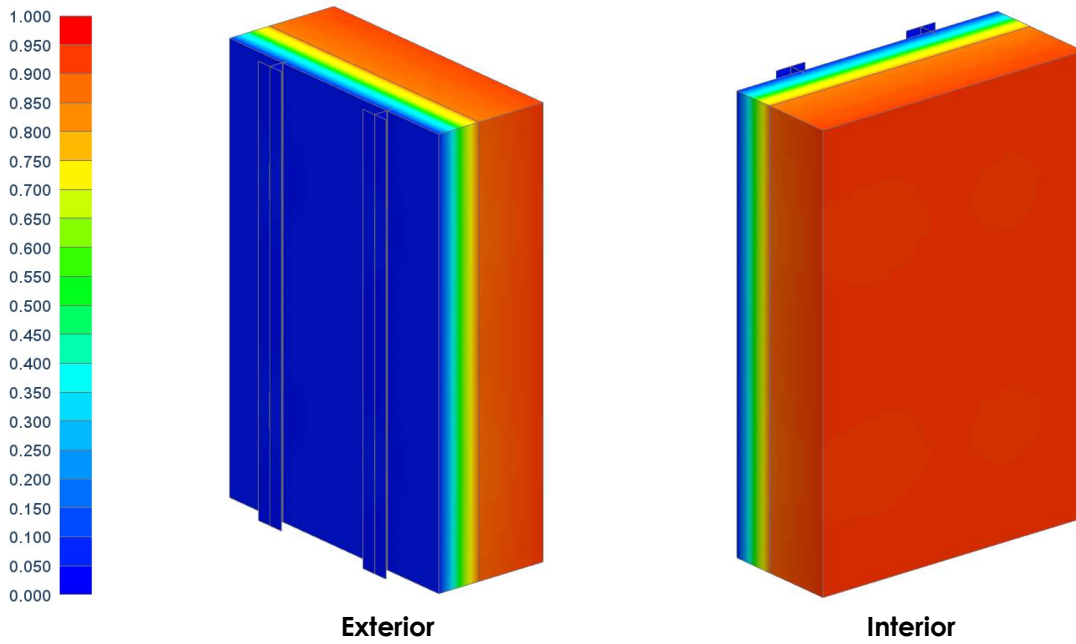

Figure E6: Temperature Profile of Stainless Steel 160 GP Bracket with Poured-in-Place Concrete

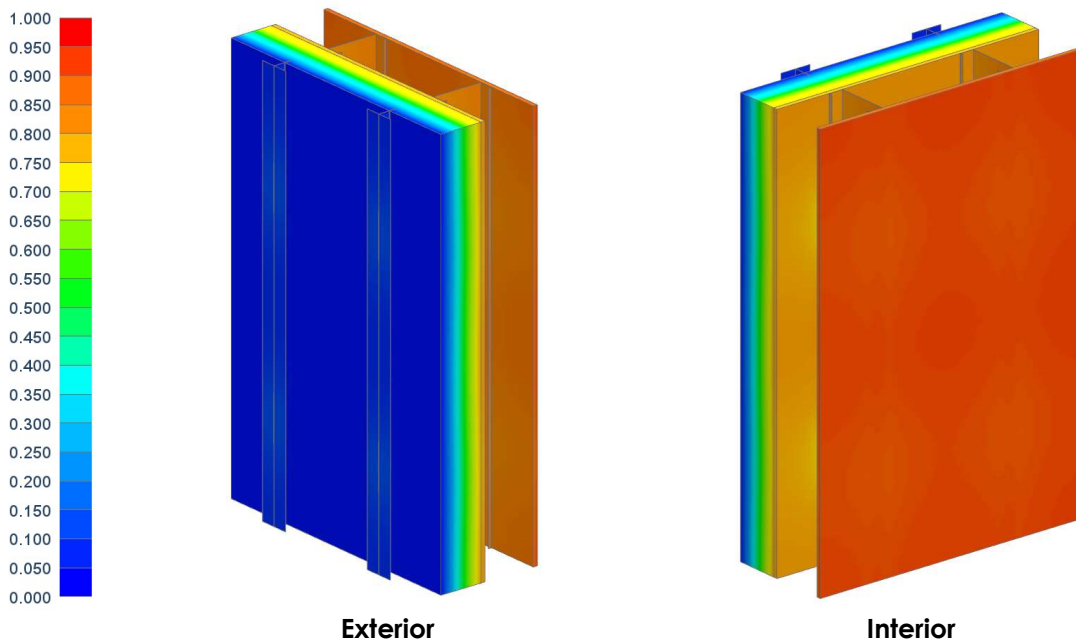

Figure E7: Temperature Profile of Aluminum 160 FP Bracket with No Thermal Break; Exterior Insulated Steel Stud

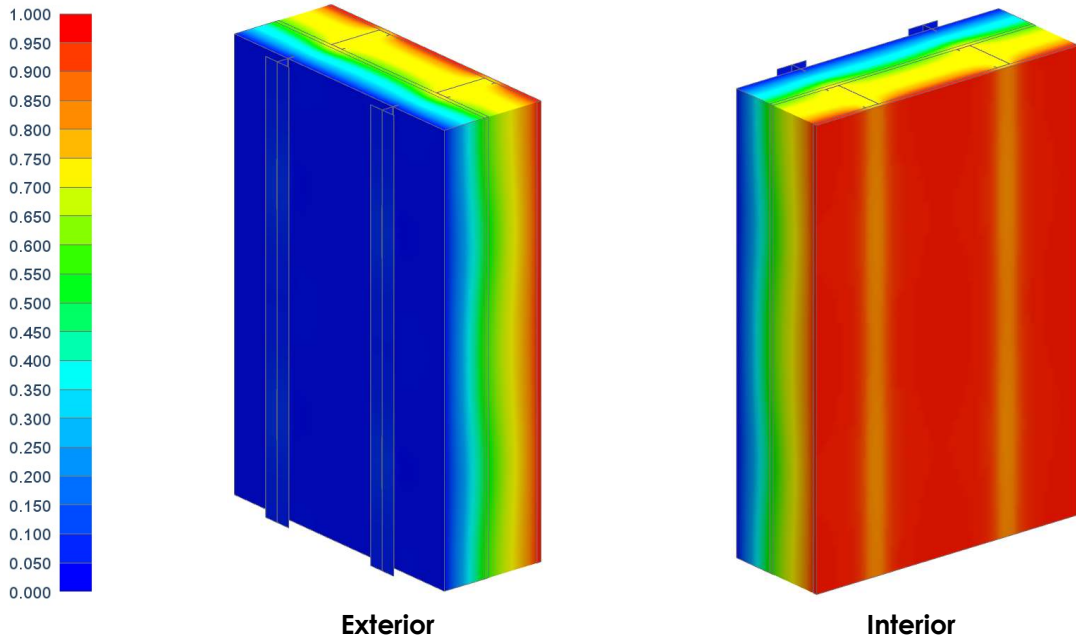

Figure E8: Temperature Profile of Aluminum 160 FP Bracket with No Thermal Break; Split Insulated Steel Stud

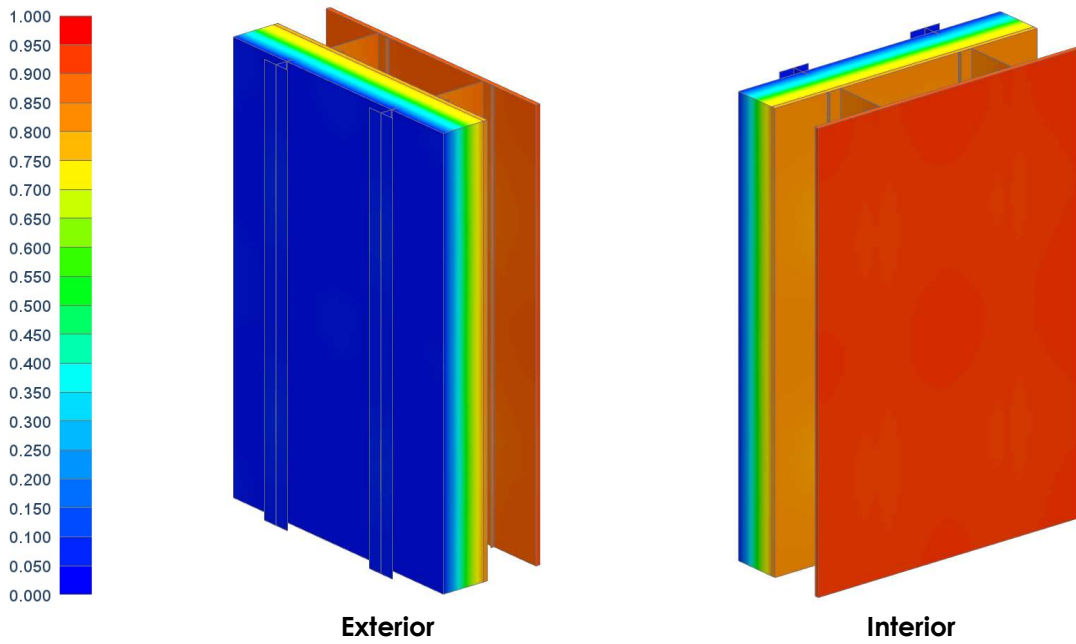

Figure E9: Temperature Profile of Stainless Steel 160 FP Bracket with No Thermal Break; Exterior Insulated Steel Stud

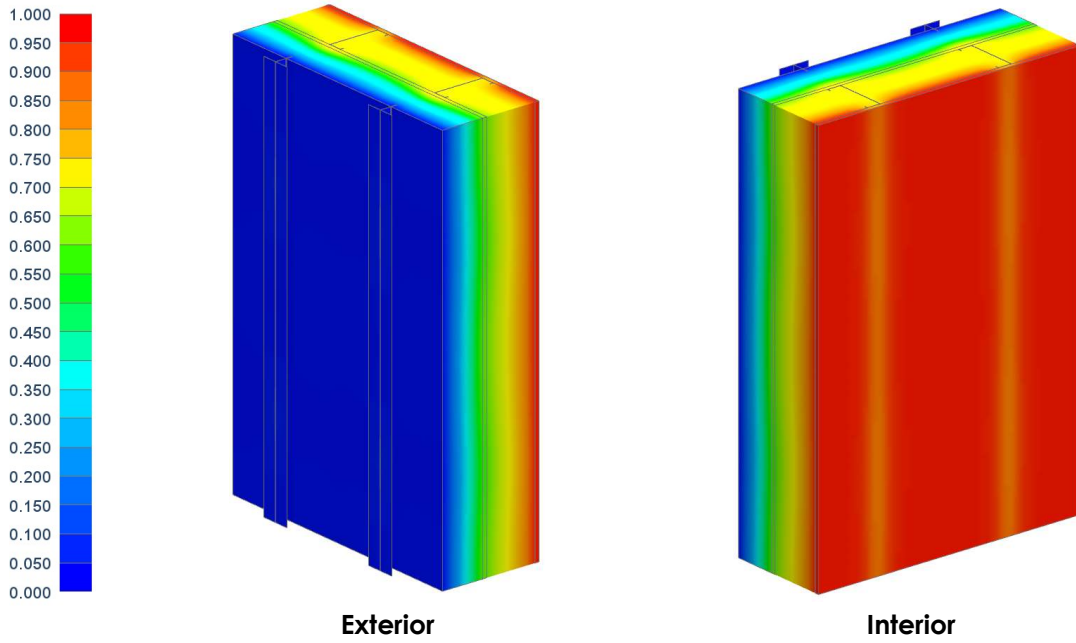

Figure E10: Temperature Profile of Stainless Steel 160 FP Bracket with No Thermal Break; Split Insulated Steel Stud

APPENDIX F: GLOSSARY OF TERMS

Term	Symbol	Units Imperial	Units SI	Description
Conductivity	K	$\frac{(\text{BTU in})}{(\text{hr ft}^2 \text{ }^\circ\text{F})}$	$\frac{\text{W}}{(\text{m K})}$	The ability of a material to transmit heat in terms of energy per unit area per unit thickness for each degree of temperature difference.
Equivalent Conductivity	K_{eq}	$\frac{(\text{BTU in})}{(\text{hr ft}^2 \text{ }^\circ\text{F})}$	$\frac{\text{W}}{(\text{m K})}$	The averaged or equivalent thermal conductivity of a component consisting of several building materials, effectively treating the component as a homogeneous material that provides the same thermal characteristics.
Heat Flow	Q	BTU/hr	W	The amount of energy per unit time that passes through an assembly under a specific temperature drive of ΔT .
Thermal Transmission Coefficient	U	$\frac{(\text{BTU})}{(\text{hr ft}^2 \text{ }^\circ\text{F})}$	$\frac{\text{W}}{(\text{m}^2 \text{ K})}$	Heat flow per unit time through a unit area of an assembly per temperature degree difference. The convention is to include the impact of air films
Thermal Resistance of a Material	R	$\frac{(\text{hr ft}^2 \text{ }^\circ\text{F})}{(\text{BTU})}$	$\frac{(\text{m}^2 \text{ K})}{\text{W}}$	A measure of a material's resistance to heat flow.
Effective Thermal Resistance	R_{eff}	$\frac{(\text{hr ft}^2 \text{ }^\circ\text{F})}{(\text{BTU})}$	$\frac{(\text{m}^2 \text{ K})}{\text{W}}$	A measure of an assembly's resistance to heat flow, including the effects of thermal bridging. The inverse of the assembly U-value.
Clear Field Assembly Thermal Transmittance	U_0	$\frac{(\text{BTU})}{(\text{hr ft}^2 \text{ }^\circ\text{F})}$	$\frac{\text{W}}{(\text{m}^2 \text{ K})}$	Heat flow coefficient for an assembly with uniformly distributed thermal bridges, which are not practical to account for on an individual basis for U-value calculations. Examples of thermal bridging included in U_0 are brick ties, girts supporting cladding, and structural studs.

Term	Description
Air Films	An approximation of the combined radiative and conductive-convective heat exchange at air boundary surfaces.
Clear Field Assembly	Wall, floor and roof assemblies of a building. (see definition of U_0 above).
Opaque Assembly	All areas in the building envelope, except fenestration and building services openings such as vents and grilles.
Poured-in-Place Concrete Wall	An architectural exposed concrete wall that is formed at the location of installation and is part of the building structural support.
Thermal Break	A non-conductive material that interrupts a conductive heat flow path. For example, aluminum framing for glazing in cold climates typically utilizes a low conductivity material to join an exterior and interior portion of the metal framing.
Thermal Bridge	Part of the building envelope where otherwise uniform thermal resistance is changed by full or partial penetration of the thermal insulation by materials with lower thermal conductivities and/or when the interior and exterior areas of the envelope are different, such as what occurs at parapets and corners.
Thermal Modelling	The process by which the thermal performance of assemblies is determined through computer simulations utilizing heat transfer models. Assemblies can be modeled two- or three- dimensions (2D and 3D).
Thermal Performance	A broad term to describe performance indicators related to the heat transfer through an assembly. The performance indicators include thermal transmittances, effective R-values, and metrics to evaluate condensation resistance related to surface temperatures.