



Building with conscience.

# StoTherm® ci over Steel Frame

Detail Booklet

Series 52s.xx | June 2022

Facades



Exterior Wall  
Insulation Systems

Combining innovative design and high-level performance, StoTherm®ci over steel frame offers a unique approach to wall system design. A highly efficient and cost-effective solution to bolster an architect's aesthetic vision StoTherm®ci wall system provides world class performance through the integration of continuous insulation (ci), innovative air and water-resistant barrier technology, drainage and a variety of architectural surface options. They are easy to install and can be used in almost any residential or commercial setting.





# Design Guide



## Table of Contents

System Overview .....	3
System Components .....	3
Assembly Diagram .....	6
General Notes .....	6
StoGuard Product Use Chart .....	11
Additional Information .....	12
Guide Details .....	13

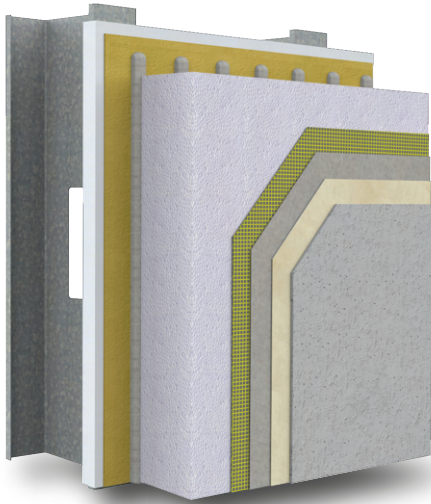

## StoTherm® ci

StoTherm ci is an exterior insulation and finish system (EIFS) for use on vertical above grade exterior walls. It incorporates an air and water-resistive barrier (AWRB), and continuous exterior insulation attached with vertical ribbons of adhesive to the AWRB, which forms a drainage cavity. An impact resistant reinforced base coat is installed over the continuous insulation, which serves as a base for Sto high performance textured finishes, StoCast finishes that simulate the look of wood, brick, stone, and other architectural finish materials, or Sto Specialty finishes that create unique architectural surfaces.

NOTE: Sto documents referenced in this booklet are in **bold** and can be viewed or downloaded by visiting the documentation center at [www.stocorp.com](http://www.stocorp.com), where other information - Guide Specification, System Bulletin, and Product Bulletins – is also available.

## Components

### Fluid Applied Air and Water-Resistive Products



**Sto Gold Coat®** - Roller or spray applied vapor-permeable air & water-resistive barrier designed for use in StoPower-wall® ci Systems.



**Sto AirSeal®** - Roller or spray applied, medium-to-high build, vapor-permeable air & water-resistive barrier for use behind siding, brick, stone, adhered veneer and other claddings.



**StoGuard VaporSeal®** - Roller or spray applied high build air and water-resistive barrier and Class 1 vapor retarder (< 0.1 perms). Provides superior protection against vapor diffusion, moisture intrusion, and air leakage.



**Sto Gold Coat® TA** - Trowel applied vapor-permeable air & water-resistive barrier for use behind siding, brick, stone, adhered veneer, and other claddings.

### Detail Component Products



**Sto Gold Fill®** - Trowel applied joint treatment and air barrier material used to treat rough openings, corners, and sheathing joints with StoGuard® Mesh or Sto Detail Mesh.



**Sto RapidGuard™** - One-component air barrier and waterproof material used to protect rough openings, sheathing joints, seams, cracks, penetrations, and other transitions in above grade wall construction.



**StoGuard® Fabric** - Non-woven cloth reinforcement to treat joints, inside and outside corners and rough openings when embedded in Sto Gold Coat, Sto AirSeal or Sto VaporSeal.





**StoGuard® Mesh** - Glass fiber, self-adhesive mesh for use with Sto Gold Fill and Sto Gold Coat TA as part of the StoGuard assembly.





## Detail Component Products (cont'd)

 **Sto Mesh, Sto Intermediate Mesh & Sto Detail Mesh** - A variety of designed coated glass fiber meshes used to provide reinforcement and impact resistance in Sto claddings.

 **Sto Armor Mat & Sto Armor Mat XX** - A heavy, specifically designed coated glass fiber mesh used to provide ultra-high impact resistance in Sto claddings.

 **StoGuard® RediCorner** - A preformed StoGuard® fabric piece used in the corners of rough openings for quicker installation.

 **StoGuard® Transition Membrane** - Flexible air barrier material used to make connections with adjoining construction to achieve continuity of the air barrier assembly at dynamic joints and dissimilar materials.

 **StoGuard® Tape** - A self-adhering membrane composed of spun bond polyester fabric laminated to rubberized asphalt adhesive for use as rough opening protection at windows and doors. StoGuard® Primer required.

## Insulation Adhesive

 **Sto TurboStick®** - is a ready-to-use, single component polyurethane foam adhesive used for securing insulation panels to the substrate and filling seams and gaps in insulation board surface.

## Base Coats/Adhesive

 **Sto BTS® Plus** - A trowel or spray applied, one-component, polymer-modified, high build cement based, dry powder material used as an adhesive and base coat.

 **Sto BTS® Xtra** - A trowel or spray applied, lightweight factory blended one component polymer modified portland cement based extra high build base coat.

 **Sto RFP** - A trowel or spray applied, ready mixed acrylic based fiber reinforced base coat material used as an adhesive and base coat.

 **Sto Flexyl** - A trowel or spray applied, ready mixed acrylic based fiber reinforced base coat material used as an adhesive and base coat.

## Primer

 **StoPrime® Sand** - A roller, brush or sprayed applied, tintable, sanded primer used to reduce surface water absorption of the base coat, and to enhance finish color, texture, and coverage of finishes.

 **StoPrime®** - A roller, brush or sprayed applied, tintable, used to reduce surface water absorption of the base coat, and to enhance finish color, texture, and coverage of finishes.



## Primer (cont'd)



**StoPrime® UV** - A roller, brush or sprayed applied primer used for prepared concrete, masonry, plaster, EIFS base coat, or drywall surfaces prior to application of Sto Finishes and Coatings

## Finishes



**StoLit® Lotusan®** - A trowel or sprayed applied, ready-mixed, acrylic-based wall finish with Lotus-Effect® Technology for highest water repellency and resistance to soiling. Available in a variety of graded marble aggregates, as well as standard and specialty textures.

NOTE: Please visit [www.stocorp.com](http://www.stocorp.com) for more information on a wide range of available Sto Finish options for StoTherm®ci including; StoSignature, StoCast (Wood and Brick), Stolit®, Stolit® X, Sto Powerflex, StoPowerwall®, Sto Essence DPR, and Sto Powercryn finishes.



Figure 1.0

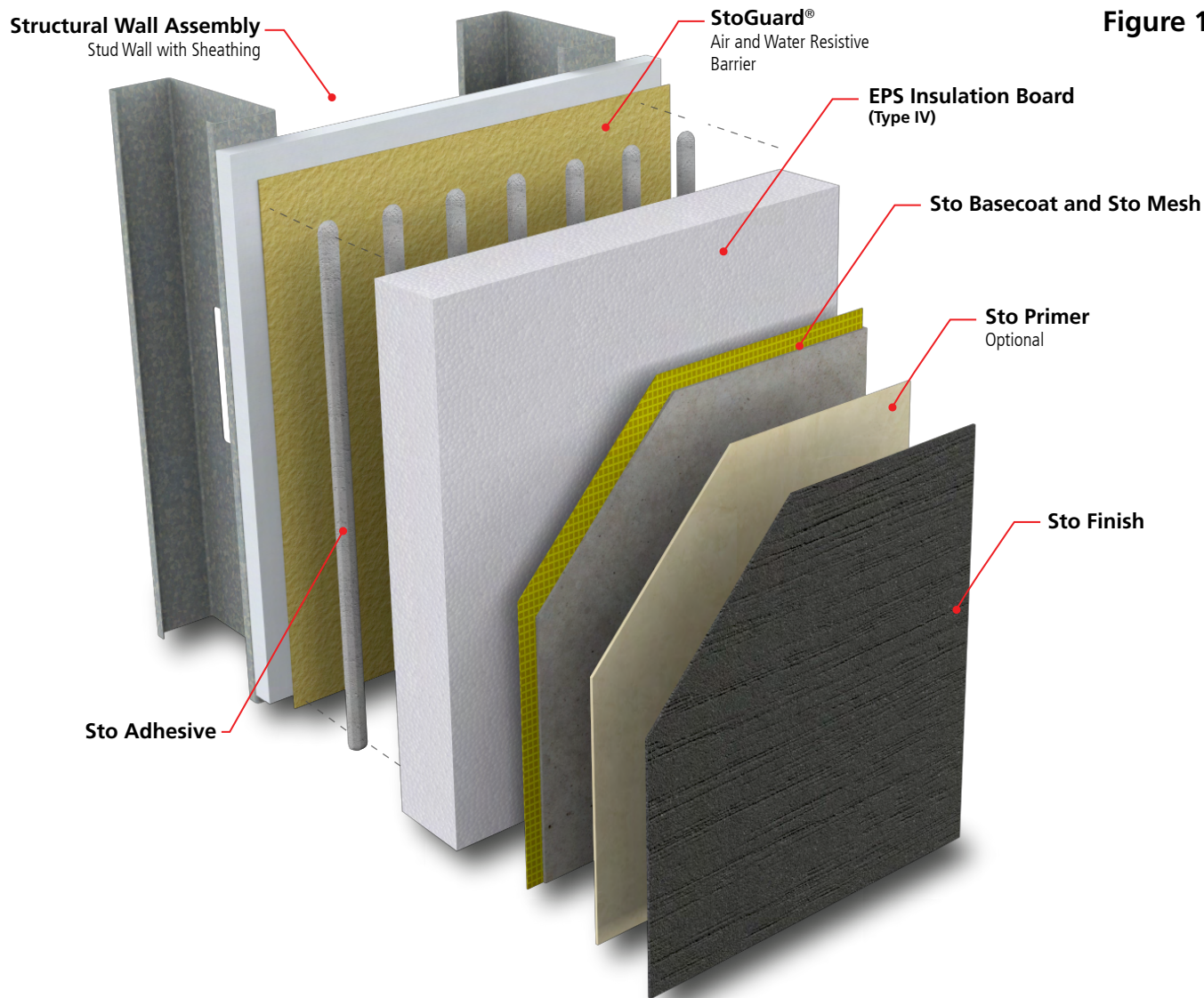

## Structural Considerations

1. StoTherm® ci is a non-structural exterior wall cladding. It is non-load bearing and does not provide racking resistance, nor is it to be used as a base for mechanical anchoring of attachments such as signage or light fixtures. The structural backup wall, typically concrete, concrete masonry, or a frame wall with sheathing, must be designed and built for these purposes in accordance with the applicable building code.

2. Wind Loads: Design deflection criteria for StoTherm® ci is L/240. StoTherm® ci transfers positive wind loads to the supporting wall construction and resists negative wind loads via adhesive attachment to a substrate.

Generally, StoTherm® ci is not the determinant of ultimate wind load capacity on frame walls. The supporting frame wall construction, or sheathing attachment, typically dictates ultimate load capacity of the assembly. Consult [ICC ESR-1748](#) for allowable wind loads (published values have a safety factor of 3x applied to ultimate loads). In some cases, such as painted wall substrates, where adhesion may not be possible, full mechanical attachment is necessary. Refer to [ICC ESR-1030](#) for information on allowable wind loads of mechanically attached StoTherm® ci systems.



## Fire Protection

StoTherm®ci uses combustible foam plastic insulation as its insulating component. Use of foam plastics on exterior walls is covered in Chapter 26 of the IBC (International Building Code), which requires certain tests to allow use of foam plastics on noncombustible construction. Based on testing of StoTherm® ci in accordance with NFPA 285 and NFPA 268 (and other fire tests and criteria listed in the code), the system complies with requirements for use on noncombustible construction (Types I, II, III, and IV). The system may also be used on combustible (Type V) construction.

Where a fire resistance rating is required, in general, StoTherm®ci does not add to nor detract from the rating of an hourly rated load bearing or non-load bearing concrete, concrete masonry, or steel frame base wall assembly, based on testing in accordance with ASTM E119.

Refer to [ICC ESR-1748](#) for more information on tested assemblies. Note that certain assemblies may be extended beyond the recognition provided in the ICC evaluation report through engineering judgments on file at Sto Corp., or by way of modeling or rational analysis applied to the particular product or assembly in question.

## Moisture Protection

1. **General:** StoTherm®ci has redundant built-in moisture protection with StoGuard®, the air and water-resistive barrier component in the assembly. StoGuard® is applied to the structural backup wall and protects against water damage from rain during construction when the building is "closed-in," and in the event of a breach in the wall cladding while in service. StoGuard® is available as a vapor permeable or vapor impermeable fluid-applied membrane.

The system also has built-in drainage capability. When properly combined with flashing, the system effectively drains water, based on testing in accordance with ASTM E2273.

StoGuard® is not intended to correct faulty design or workmanship, such as the absence or improper integration of flashing, roofing, copings, and sealants in the construction, which shed water and prevent water entry into wall construction. StoGuard® is not intended to correct defective components of construction such as windows that leak into the wall assembly. Basic principles that should be followed in the design, detailing, and construction of the wall assembly include:

2. **Flashing:** provide flashing to direct water to the exterior where it is likely to penetrate components in the wall assembly, including, above window and door heads, beneath window and door sills, at roof/wall intersections, decks, abutments of lower walls with higher walls, above projecting features, at floor lines, and at the base of the wall.
3. **Air Leakage Prevention:** provide continuity of the air barrier assembly at foundation, roof, windows, doors, and other penetrations through the wall with connecting and compatible air barrier components, to minimize condensation caused by air movement. In most cases StoGuard Detail Components will facilitate detailing at these transitions. Take into account construction sequencing when designing an airtight assembly and the effects of airtightness on mechanical ventilation in the overall project design.
4. **Water Vapor Diffusion:** perform a dew point analysis and/or dynamic hygrothermal modeling of the wall assembly to determine the potential for accumulation of moisture by diffusion of water vapor. Adjust insulation thickness and/or other wall assembly components accordingly to eliminate or minimize the risk of a dew point in the wall assembly. Avoid the use of vapor retarders on the interior side of the wall in hot, humid climates.



## Moisture Protection (cont'd)

5. Terminations and Sealants: Provide minimum 1/2 inch (13 mm) wide perimeter sealant joints at all penetrations through StoTherm® ci (windows, doors, scuppers, mechanical, electrical, and plumbing penetrations, etc.).
6. Size joints at terminations based on anticipated movement and specify sealant and backer rod that is compatible with StoTherm® ci, supported by the sealant manufacturer's certificate of compatibility. Typically, sealant is adhered to the StoTherm ci reinforced base coat or primed base coat.

Arrange for field adhesion testing to verify adhesion compatibility and obtain the sealant manufacturer's adhesion data to the sealant substrate(s).

Maintain air barrier continuity across joints. Drain joints to the exterior or provide other means to prevent or control water infiltration at joints.

7. Grade Condition: Provide minimum 6-inch (152mm) clearance above grade or as required by code. Do not specify StoTherm® ci for use below grade.
8. Testing: conduct mock-up testing of the opaque wall-to-window assembly and other critical construction details to verify performance – air leakage resistance (ASTM E283), resistance to wind-driven rain (ASTM E331), and wind load resistance (ASTM E330).

Do not use StoTherm® ci on surfaces subject to continuous or intermittent water immersion or hydrostatic pressure. Prevent the accumulation of water behind StoTherm ci, either by condensation or water leakage into the wall construction, in the design and detailing of the wall assembly, and with proper sequencing and protective measures during construction.

For further information see **Sto Tech Hotline No. 0403-BSc, Critical Detail Checklist for Wall Assemblies**, **Sto Tech Hotline No. 0603-BSc, Moisture Control Principles for Design and Construction of Wall Assemblies**, and **Sto Tech Hotline No. 1001-BSc, Effects of Temporary Heating on Construction Materials in Cold Weather**.

## Impact Resistance

StoTherm® ci meets standard, medium, high, and ultra-high impact resistance ratings, depending on the type of mesh reinforcement used with the base coat, when tested in accordance with [ASTM E2458](#). Ultra-high impact resistance is recommended at ground floors to a minimum height of 6 ft (1.8m) and at any other areas of abnormal stress or impact. Alternatively, StoTherm® ci MVES with adhered thin brick, stone, or tile can be used to provide a more impact resistant finished wall surface at ground floors. Refer to Sto Details.

The system also meets FBC (Florida Building Code) and Miami-Dade County test protocols for large and small missile impact resistance (with supplemental mesh reinforcement of the sheathing surface on frame walls with gypsum sheathing). Refer to Miami-Dade County NOAs.

## Acoustics

Acoustical controls are achieved primarily in the base wall assembly, for example, in frame wall construction through the use of batt insulation in the stud wall cavity, gypsum sheathing, and wood or metal stud configuration. Refer to the Gypsum Association Fire Resistance and Sound Control Design Manual for technical data on performance of base wall assemblies.





## Aesthetics

A wide variety of aesthetic choices and colors exist with Sto textured finishes, available in smooth, fine, medium, and coarse textures that are applied by trowel or spray application. Sto Specialty finishes offer unique architectural surfaces through the use of colored aggregate blends that are applied by trowel or spray application. StoCast finishes are factory made veneer units that achieve the look of wood, stone, brick, and other architectural finishes in a range of sizes, styles, and colors, with simplified application methods.

Dark colored finishes [LRV (Light Reflectance Value) less than 20] are not recommended unless reviewed by the design professional with regard to service temperature limitations of the foam plastic insulation [(limited to a maximum service temperature of 165°F (74.8°C)], and anticipated temperatures on the façade surface through the life of the building.

Architectural features – trim, sills, ledges, build-outs, reveals: all trim and projecting architectural features must have a minimum 1:2 [27°] slope along their top surface. All reveals must have minimum ¾ inch (19 mm) insulation thickness at the bottom of the reveal. All horizontal reveals must have a minimum 1:2 [27°] slope along their bottom surface. Increase slope for northern climates to prevent accumulation of ice/snow and water on sloped surfaces. Where trim/feature or bottom surface of reveals project more than 2 inches (51 mm) from the face of the EIFS wall plane, protect the top surface with waterproof base coat. Periodic inspections and increased maintenance may be required to maintain surface integrity of the finish on weather exposed sloped surfaces. Limit projecting features to easily accessible areas and limit total area to facilitate and minimize maintenance. Refer to Sto Details.

Do not use StoTherm®ci on top of parapets or on large weather exposed projecting ledges, sills, or other projecting features unless supported by framing or other structural support and protected with metal coping or flashing.

## Joints

Joints are required at:

- Joints in the supporting wall construction such as expansion joints, control joints, and cold joints
- Perimeters of windows, doors, scuppers, fixture attachments, and similar objects in the wall construction
- Changes in substrate or support construction (e.g., masonry to frame wall) or other junctures with dissimilar construction
- Floor lines in multi-story wood frame wall construction
- Floor line deflection joints
- Changes in building height and other areas of stress concentration
- Panel-to-panel joints in prefabricated panel wall construction

Do not bridge expansion joints, control joints, or cold joints in wall construction with StoTherm®ci.

## Regulatory Compliance

The StoTherm®ci System complies with the weather resistance requirements of the 2018 IBC Sections 1407.2 and 1407.4, and complies with requirements of Chapter 26 for use on noncombustible construction (Types I, II, II, and IV), and on fire-resistance rated wall assemblies. The system also complies with ASHRAE 90.1-2019 Section 5, Building Envelope, air barrier and continuous insulation requirements.

StoGuard complies with IBC, IRC, and IECC (International Energy Conservation Code) requirements as an air barrier material and water-resistive barrier. It meets requirements as an air barrier material based on testing in accordance with ASTM E2178 and as an air barrier assembly based on testing in accordance with ASTM E2357. Refer to ICC ESR-1233.

All Sto architectural coatings, textured and specialty finishes, primers, sealers, waterproofers, and underlayments comply with South Coast Air Quality Management District (South Coast AQMD) volatile organic compound (VOC) requirements.



## Thermal Insulation

StoTherm®ci uses expanded polystyrene (EPS) insulation board as the thermal insulating component. The insulation board is applied adhesively to StoGuard on a supporting substrate to create a continuous exterior insulating thermal barrier. Thickness is limited based on structural considerations and fire testing. Minimum thickness is 1 inch (25mm). Maximum thickness is 12 inches (305mm) on noncombustible construction, and in some cases may be limited to six inches (152mm), depending on finish selection. Refer to ICC ESR-1748. If walls are required to have an hourly fire-resistance rating, maximum thickness is 4 inches.

Sto EPS Insulation conforms with ASTM E2430 and ASTM C578 Type I requirements. R-value is R-3.6 F•ft<sup>2</sup>•h/Btu per inch thickness at 75°F (RSI-0.634 K•m<sup>2</sup>/W per 25mm at 24°C).

Insulation material is flammable and must be kept away from flame, ignition sources, high heat and temperatures in excess of 165°F [74.8° C]).

## Sustainability

StoTherm®ci has high potential for LEED and other sustainability program credits based on efficient and effective use of a continuous air barrier, continuous exterior insulation, and the resulting energy savings and reductions in greenhouse gas emissions. The system also has positive impacts on life cycle energy use based on reduced dead load, which permits the use of lighter gage metal studs, and supporting structural members and foundation footings, when compared to other wall systems such as full thickness/weight masonry veneer walls. The use of light gage metal framing with recycled content and StoPanel prefabricated wall construction offers additional means to obtain credits. Refer to StoPanel Technology information and ICC ESR-4500.



**Table 1.1 - StoGuard® Product Application**

StoGuard® Detail Component	Sheathing Joints and Corners	Rough Opening Protection	Counter Flashing, Penetrations	Static Joints and Seams	Dynamic Joints
StoGuard® Fluid Applied Air & Water-Resistive Barrier with StoGuard® Fabric	✓	✓	✓		
Sto Gold Coat® TA with StoGuard® Mesh embedded	✓	✓	✓		
Sto Gold Fill with StoGuard® Mesh or StoGuard® Detail Mesh embedded	✓	✓	✓		
Sto RapidGuard®	✓	✓	✓	✓	
StoGuard® Conformable Membrane	✓	✓	✓	✓	✓
StoGuard® Transition Membrane embedded with any StoGuard® Fluid Applied Air & Water-Resistive Barrier				✓	✓



## Additional Information

Refer to Sto product bulletins, guide specifications and guide details, technical hotlines, ICC Evaluation Reports, and other sources of information available at [www.stocorp.com](http://www.stocorp.com) for more details on specific Sto products, features, benefits, and limitations that apply to StoTherm ci wall systems and components.

### References:

1. American Society of Testing and Materials International (ASTM), Standard Specification for Rigid Cellular Polystyrene Thermal Insulation, ASTM C578.
2. American Society of Testing and Materials International (ASTM), Standard Test Methods for Fire Tests of Building Construction and Materials, ASTM E119.
3. American Society of Testing and Materials International (ASTM), Standard Test Method for Determining Rate of Air Leakage Through Exterior Windows, Curtain Walls, and Doors Under Specified Pressure Differences Across the Specimen, ASTM E283.
4. American Society of Testing and Materials International (ASTM), Standard Test Method for Structural Performance of Exterior Windows, Doors, Skylights, and Curtain Walls by Uniform Static Air Pressure Difference, ASTM E330.
5. American Society of Testing and Materials International (ASTM), Standard Test Method for Water Penetration of Exterior Windows, Skylights, Doors, and Curtain Walls by Uniform Static Air Pressure Difference, ASTM E331.
6. American Society of Testing and Materials International (ASTM), Standard Test Method for Determining Rate of Air Leakage Rate and Calculation of Air Permeance of Building Materials, ASTM E2178.
7. American Society of Testing and Materials International (ASTM), Standard Test Method for Determining the Drainage Efficiency of Exterior Insulation and Finish System (EIFS) Clad Wall Assemblies, ASTM E2273.
8. American Society of Testing and Materials International (ASTM), Standard Specification for Expanded Polystyrene ("EPS") Thermal Insulation Boards for Use in Exterior Insulation and Finish Systems ("EIFS"), ASTM E2430.
9. American Society of Testing and Materials International (ASTM), Standard Test Method for Determining Air Leakage Rate of Air Barrier Assemblies, ASTM E2357.
10. American Society of Refrigeration and Air Conditioning Engineers (ASHRAE), Energy Efficiency Standard for Buildings Except Low-Rise Residential Buildings, ANSI/ASHRAE/IES Standard 90.1-2019.
11. Gypsum Association, Fire Resistance and Sound Control Design Manual, GA-600-2021.
11. Gypsum Association, Fire Resistance and Sound Control Design Manual, GA-600-2021.
12. International Code Council Evaluation Service, Sto Rainscreen and Sto Rainscreen II Class PB Exterior Insulation and Finish Systems with Drainage, ICC ESR-1030.
13. International Code Council Evaluation Service, StoGuard with Sto Gold Coat, StoGuard with Sto EmeraldCoat, and StoGuard VaporSeal Air Barriers and Water-resistive Barriers, and StoEnergy Guard (StoGuard with Continuous Insulation), ICC ESR-1233.
14. International Code Council Evaluation Service, StoTherm ci, StoTherm ci, and StoTherm ci with StoCast Finishes, ICC ESR-1748.
15. International Code Council Evaluation Service, StoPanel Classic ci, StoPanel Impact ci, StoPanel XPS, StoPanel Classic NExT ci, and StoPanel Backup, ICC ESR-4500.
16. International Code Council, Inc., 2018 International Building Code (IBC).
17. International Code Council, Inc., 2018 International Energy Conservation Code (IECC).
18. International Code Council, Inc., 2018 International Residential Code (IRC).
19. National Fire Protection Association (NFPA), Standard Test Method for Determining Ignitability of Exterior Wall Assemblies Using a Radiant Heat Energy Source, NFPA 268.
20. National Fire Protection Association (NFPA), Standard Fire Test Method for Evaluation of Fire Propagation Characteristics of Exterior Wall Assemblies Containing Combustible Components, NFPA 285.
21. Sto Corp., Critical Detail Checklist for Wall Assemblies, TH-0403-BSc.
22. Sto Corp., Moisture Control Principles for Design and Construction of Wall Assemblies, TH-0603-BSc.
23. Sto Corp. Effects of Temporary Heating on Construction Materials in Cold Weather, TH-1001-BSc.



# Design Details

## Components

System Components .....	52s.00
System Components with StoCast Brick .....	52s.00 SCB
System Components with StoCast Wood .....	52s.00 SCW
System Components with Ultra-High Impact Resistance .....	52s.01

## Installation at Grade

Termination at Grade: Sheathing Flush with Foundation or Slab Edge .....	52s.03A
Termination at Grade: Sheathing Overlapping Slab or Foundation .....	52s.03B

## Installation of Aesthetic Feature

Aesthetic Feature Band .....	52s.04
Aesthetic Reveal .....	52s.05

## Installation at Windows

Receptor-Type Window Sill: Rough Opening Protection .....	52s.23 A1
Receptor-Type Window Sill: Receptor with End Dam .....	52s.23 A2
Receptor-Type Window Sill: Window and Sill Flashing, Cladding, and Perimeter Weather and Air Seals.....	52s.23 A3
Receptor-Type Window Head: Rough Opening Protection/Flashing .....	52s.23 B1
Receptor-Type Window Head: Receptor and Window .....	52s.23 B2
Receptor-Type Window Head: Cladding, and Perimeter Weather and Air Seals.....	52s.23 B3
Flanged Window Sill: Rough Opening Protection/Flashing .....	52s.24 A1
Flanged Window Sill: Window and Trim .....	52s.24 A2
Flanged Window Sill: Cladding, and Perimeter Weather and Air Seals.....	52s.24 A3
Flanged Window Head: Rough Opening Protection/Flashing .....	52s.24 B1
Flanged Window Head: Window and Trim .....	52s.24 B2
Flanged Window Head: Cladding, and Perimeter Weather and Air Seals.....	52s.24 B3

## Installation at Soffit

Soffit: Insulated and Unvented .....	52s.30
Soffit: Uninsulated and Vented .....	52s.31

## Installation at Joints

Floor Line Without Deflection .....	52s.40
Floor Line With Deflection - Concealed Flashing and Drainage at Floor Line .....	52s.41A
Floor Line With Deflection - No Drainage at Floor Line .....	52s.41B

## Installation at Balcony/Abutments

Balcony Floor/Wall .....	52s.42A
Balcony Ceiling/Wall .....	52s.42B

## Installation at Dissimilar Cladding

Horizontal Termination at Dissimilar Cladding .....	52s.50
Vertical Termination at Dissimilar Cladding .....	52s.51A
Vertical Termination at Dissimilar Backup Wall Construction.....	52s.51B

(Continued on Page 3)



# Design Details (cont'd)

## Installation at Joints

Vertical Expansion Joint in Back-Up Wall .....	52s.52A
Vertical Expansion Joint in Back-Up Wall, StoTherm® ci and Dissimilar Cladding .....	52s.52B

## Installation at Corners

Inside Corner with Dissimilar Backup Wall .....	52s.53
Inside and Outside Corner with Common Substrate and StoMesh Corner Bead Reinforcement .....	52s.54A
Inside and Outside Corner with Common Substrate and StoMesh Reinforcement .....	52s.54B

## Installation at Parapets, Gravel Stop, Roofline

Termination at Parapet - Front .....	52s.60A
Termination at Parapet - Back .....	52s.60 B
Parapet at Cornice Feature .....	52s.61
Diverter Flashing at Roof/Wall Abutment .....	52s.62
Gravel Stop .....	52s.63
Saddle Flashing at Lower/Higher Wall Abutment: Air & Water-Resistive Barrier .....	52s.64-1
Saddle Flashing at Lower/Higher Wall Abutment: Flashing .....	52s.64-2
Saddle Flashing at Lower/Higher Wall Abutment: Cladding, Coping and Sealant .....	52s.64-3

## Installation at Penetrations

Scupper Penetration .....	52s.65
Pipe Penetration - Precision Cut Sheathing .....	52s.70A
Pipe Penetration - Rough Cut Sheathing .....	52s.70B
Sign Attachment .....	52s.71
Fixture Attachment .....	52s.73



### ATTENTION

The final design of any project is the sole responsibility of the Design Professional, with considerations for compliance with local building and design codes and requirements. Sto Corp. accepts no liability for design, engineering, or workmanship of any project. The information provided herein is in addition to other technical data provided by Sto Corp. (System Bulletin, Specification, Guide Details, etc). For more information, please visit [www.stocorp.com](http://www.stocorp.com)

### Sto Corp.

3800 Camp Creek Pkwy. SW  
Bldg. 1400 • Suite 120  
Atlanta, GA 30331  
Tel: (800) 221-2397  
Fax: (404) 346-3119  
<http://www.stocorp.com>  
[helpdesk.stocorp.com](mailto:helpdesk.stocorp.com)

# StoTherm® ci System Components with Sto Textured Finish

Detail No.: 52s.00  
Date: June 2022

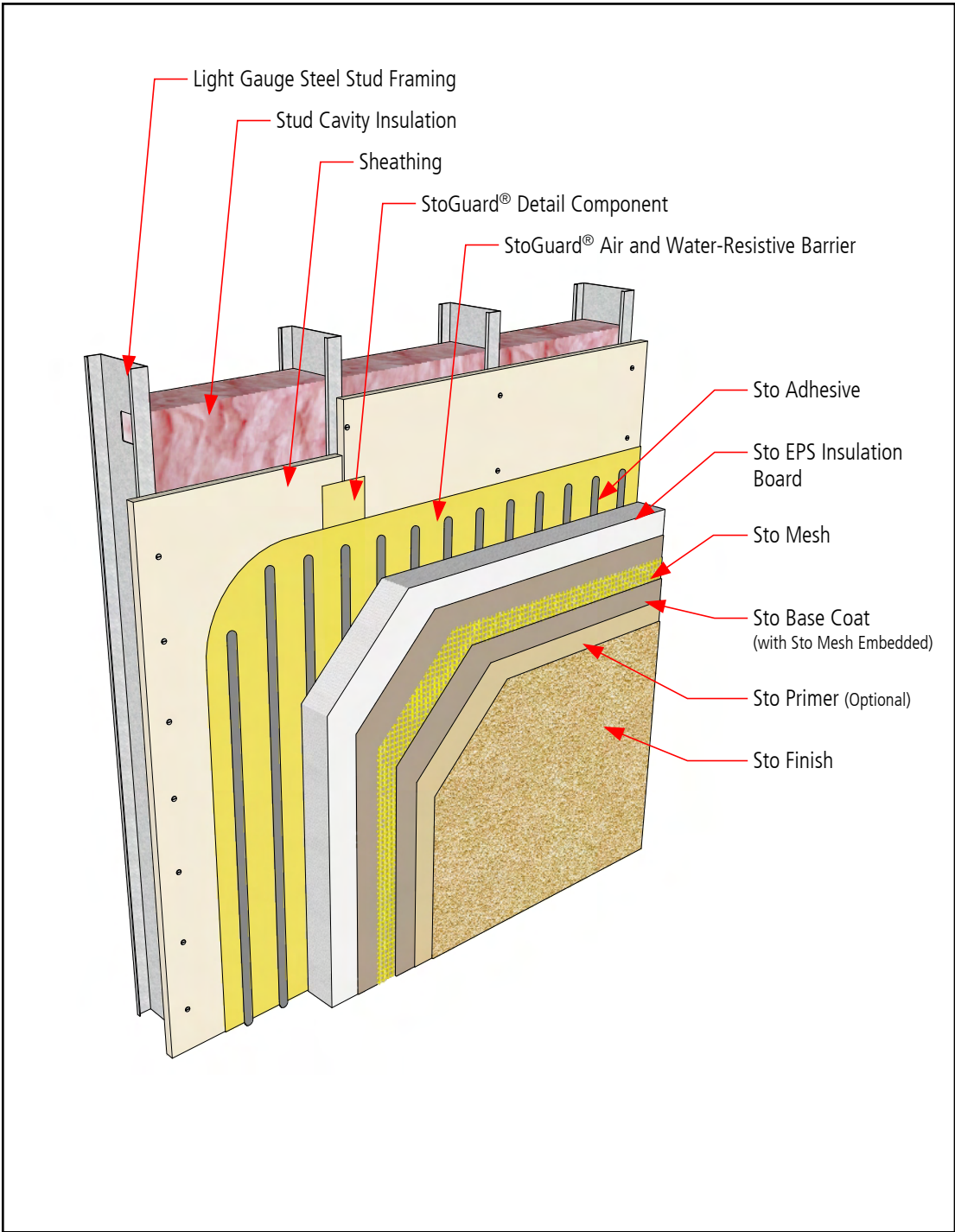

Notes:

1. Refer to StoGuard Product Use Chart (Table 1.1) for StoGuard detail components; joint treatment, rough opening protection, backing for masonry anchors, or transitions to dissimilar materials, joints and seams in construction.
2. Refer to General Notes for specific information and design guidance on wall assembly components.
3. Components not identified as Sto are furnished by other manufacturers and are not necessarily installed by trades who install the Sto products. Refer to project specific contract documents.

**ATTENTION**

Property of Sto Corp. All Rights Reserved

Sto products are intended for use by qualified professional contractors, not consumers, as a component of a larger construction assembly as specified by a qualified design professional, general contractor or builder. They should be installed in accordance with those specifications and Sto's instructions. Sto Corp. disclaims all, and assumes no, liability for on-site inspections, for its products applied improperly, or by unqualified persons or entities, or as part of an improperly designed or constructed building, for the nonperformance of adjacent building components or assemblies, or for other construction activities beyond Sto's control. Improper use of Sto products or use as part of an improperly designed or constructed larger assembly or building may result in serious damage to Sto products, and to the structure of the building or its components.

STO CORP. DISCLAIMS ALL WARRANTIES EXPRESSED OR IMPLIED EXCEPT FOR EXPLICIT LIMITED WRITTEN WARRANTIES ISSUED TO AND ACCEPTED BY BUILDING OWNERS IN ACCORDANCE WITH STO'S WARRANTY PROGRAMS WHICH ARE SUBJECT TO CHANGE FROM TIME TO TIME. For the fullest, most current information on proper application, clean-up, mixing and other specifications and warranties, cautions and disclaimers, please refer to the Sto Corp. website. [www.stocorp.com](http://www.stocorp.com)

[www.stocorp.com](http://www.stocorp.com)



# StoTherm® ci System Components with StoCast Brick

Detail No.: 52s.00B  
Date: June 2022

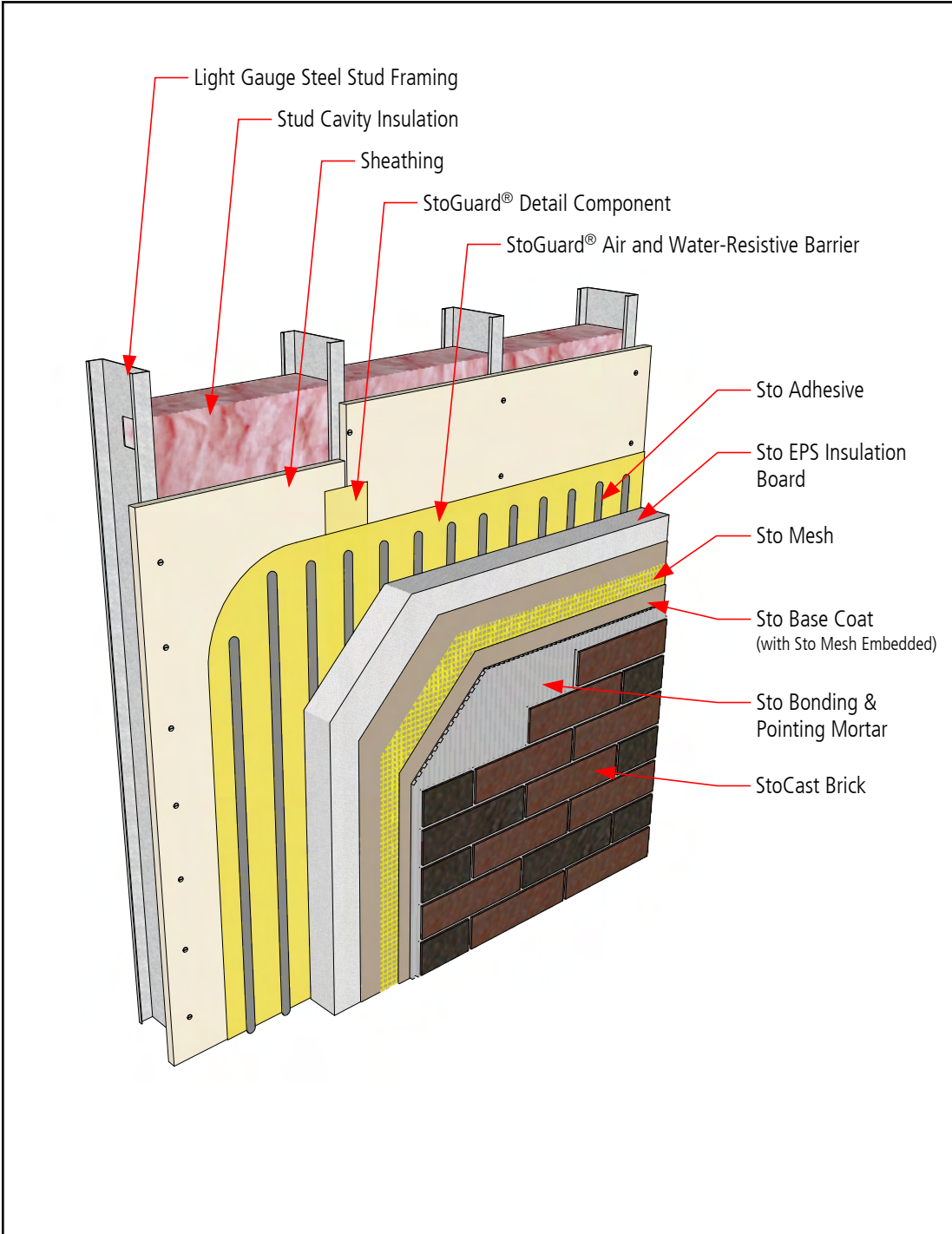

- Notes:
1. Refer to StoGuard Product Use Chart (Table 1.1) for StoGuard detail components; joint treatment, rough opening protection, backing for masonry anchors, or transitions to dissimilar materials, joints and seams in construction.
  2. Refer to General Notes for specific information and design guidance on wall assembly components.
  3. Components not identified as Sto are furnished by other manufacturers and are not necessarily installed by trades who install the Sto products. Refer to project specific contract documents.

**ATTENTION**

Property of Sto Corp. All Rights Reserved

[www.stocorp.com](http://www.stocorp.com)

Sto products are intended for use by qualified professional contractors, not consumers, as a component of a larger construction assembly as specified by a qualified design professional, general contractor or builder. They should be installed in accordance with those specifications and Sto's instructions. Sto Corp. disclaims all, and assumes no, liability for on-site inspections, for its products applied improperly, or by unqualified persons or entities, or as part of an improperly designed or constructed building, for the nonperformance of adjacent building components or assemblies, or for other construction activities beyond Sto's control. Improper use of Sto products or use as part of an improperly designed or constructed larger assembly or building may result in serious damage to Sto products, and to the structure of the building or its components.

STO CORP. DISCLAIMS ALL WARRANTIES EXPRESSED OR IMPLIED EXCEPT FOR EXPLICIT LIMITED WRITTEN WARRANTIES ISSUED TO AND ACCEPTED BY BUILDING OWNERS IN ACCORDANCE WITH STO'S WARRANTY PROGRAMS WHICH ARE SUBJECT TO CHANGE FROM TIME TO TIME. For the fullest, most current information on proper application, clean-up, mixing and other specifications and warranties, cautions and disclaimers, please refer to the Sto Corp. website. [www.stocorp.com](http://www.stocorp.com)





# StoTherm® ci System Components with StoCast Wood

Detail No.: 52s.00W  
Date: June 2022

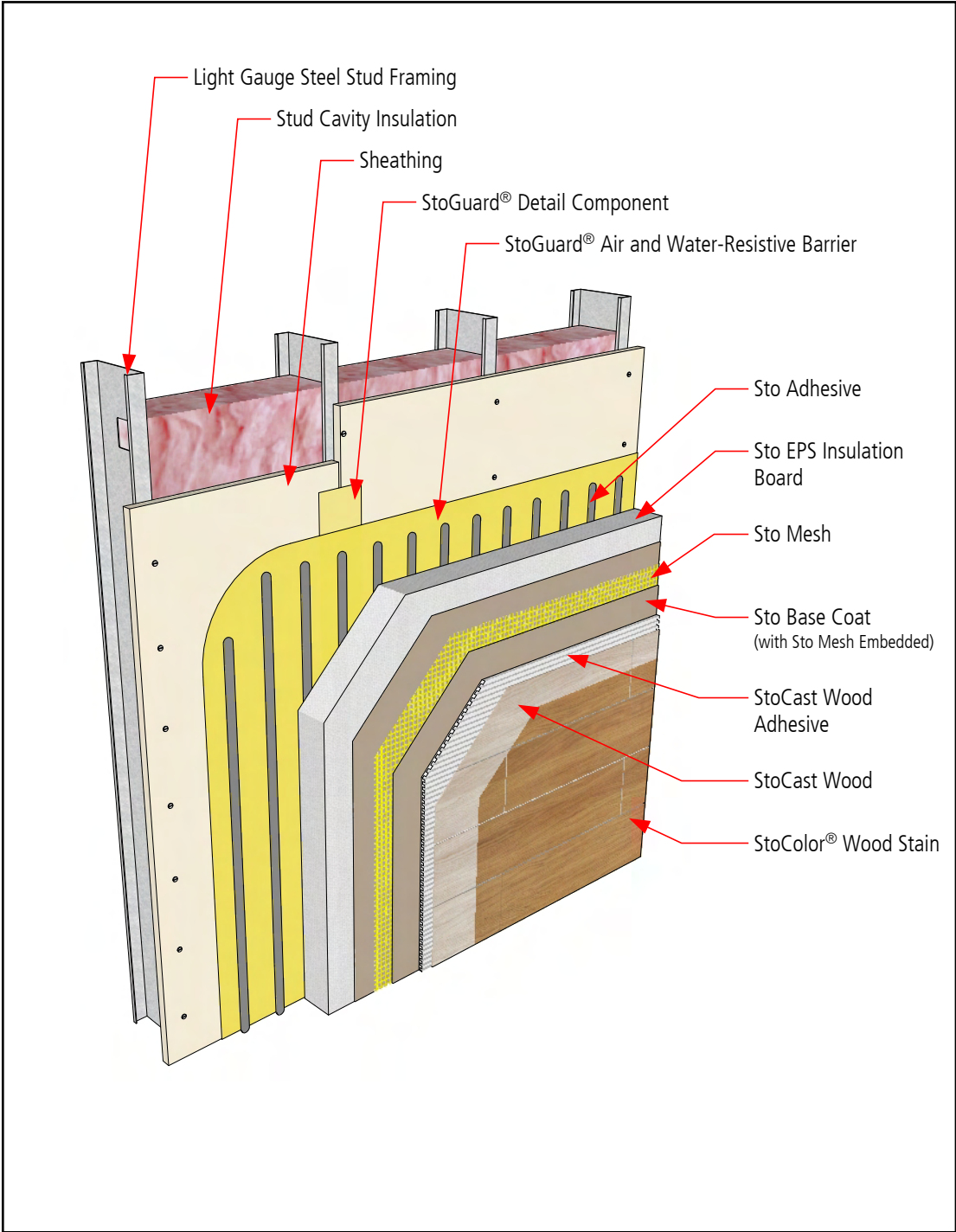

- Notes:
1. Refer to StoGuard Product Use Chart (Table 1.1) for StoGuard detail components; joint treatment, rough opening protection, backing for masonry anchors, or transitions to dissimilar materials, joints and seams in construction.
  2. Refer to General Notes for specific information and design guidance on wall assembly components.
  3. Components not identified as Sto are furnished by other manufacturers and are not necessarily installed by trades who install the Sto products. Refer to project specific contract documents.

**ATTENTION**

Property of Sto Corp. All Rights Reserved

[www.stocorp.com](http://www.stocorp.com)

Sto products are intended for use by qualified professional contractors, not consumers, as a component of a larger construction assembly as specified by a qualified design professional, general contractor or builder. They should be installed in accordance with those specifications and Sto's instructions. Sto Corp. disclaims all, and assumes no, liability for on-site inspections, for its products applied improperly, or by unqualified persons or entities, or as part of an improperly designed or constructed building, for the nonperformance of adjacent building components or assemblies, or for other construction activities beyond Sto's control. Improper use of Sto products or use as part of an improperly designed or constructed larger assembly or building may result in serious damage to Sto products, and to the structure of the building or its components.

STO CORP. DISCLAIMS ALL WARRANTIES EXPRESSED OR IMPLIED EXCEPT FOR EXPLICIT LIMITED WRITTEN WARRANTIES ISSUED TO AND ACCEPTED BY BUILDING OWNERS IN ACCORDANCE WITH STO'S WARRANTY PROGRAMS WHICH ARE SUBJECT TO CHANGE FROM TIME TO TIME. For the fullest, most current information on proper application, clean-up, mixing and other specifications and warranties, cautions and disclaimers, please refer to the Sto Corp. website. [www.stocorp.com](http://www.stocorp.com)



# StoTherm® ci

## System Components: Ultra-High Impact Resistance

Detail No.: 52s.01  
Date: June 2022

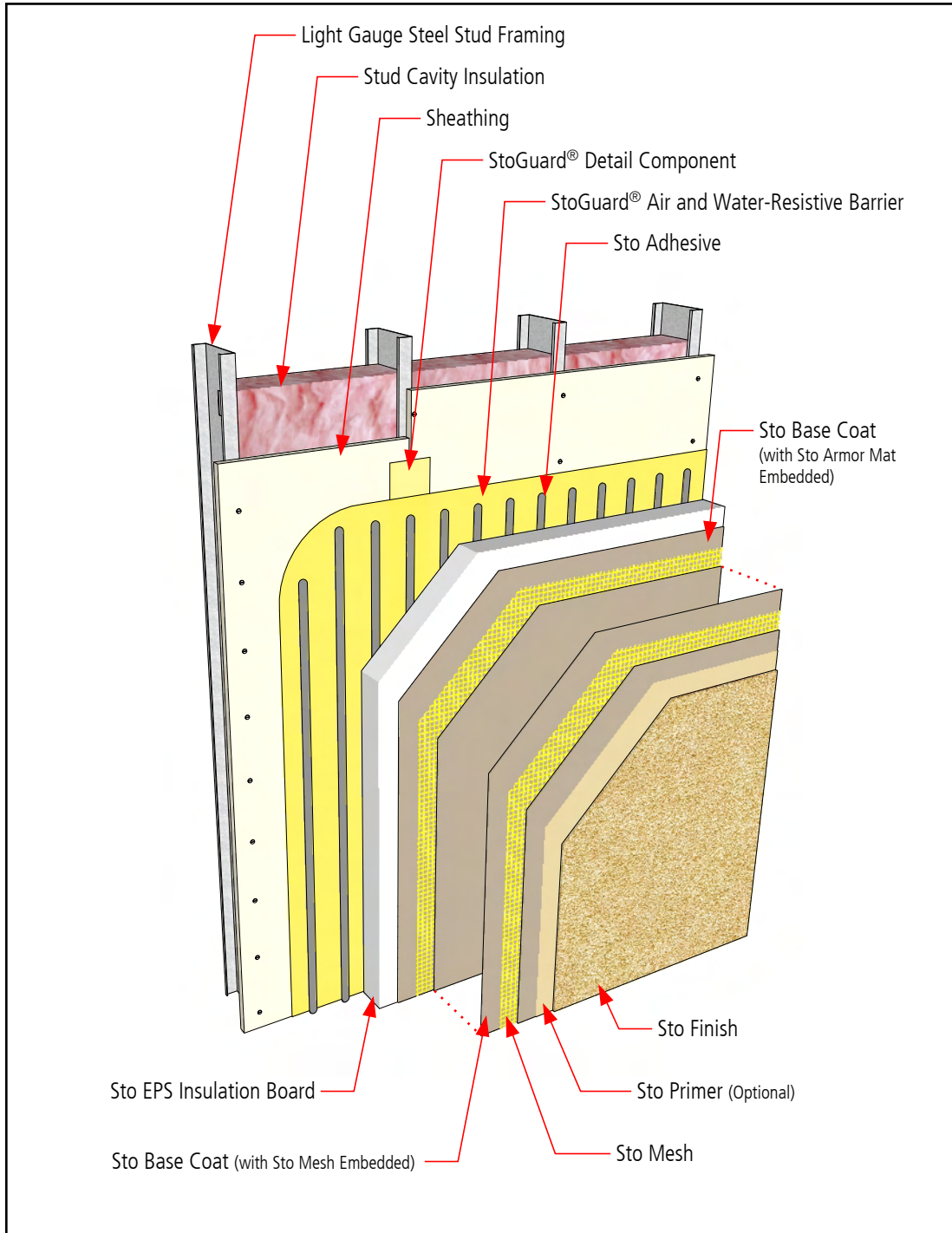

### Notes:

1. Refer to StoGuard Product Use Chart (Table 1.1) for StoGuard detail components; joint treatment, rough opening protection, backing for masonry anchors, or transitions to dissimilar materials, joints and seams in construction.
2. Refer to General Notes for specific information and design guidance on wall assembly components.
3. Components not identified as Sto are furnished by other manufacturers and are not necessarily installed by trades who install the Sto products. Refer to project specific contract documents.

### ATTENTION

Property of Sto Corp. All Rights Reserved

Sto products are intended for use by qualified professional contractors, not consumers, as a component of a larger construction assembly as specified by a qualified design professional, general contractor or builder. They should be installed in accordance with those specifications and Sto's instructions. Sto Corp. disclaims all, and assumes no, liability for on-site inspections, for its products applied improperly, or by unqualified persons or entities, or as part of an improperly designed or constructed building, for the nonperformance of adjacent building components or assemblies, or for other construction activities beyond Sto's control. Improper use of Sto products or use as part of an improperly designed or constructed larger assembly or building may result in serious damage to Sto products, and to the structure of the building or its components.

STO CORP. DISCLAIMS ALL WARRANTIES EXPRESSED OR IMPLIED EXCEPT FOR EXPLICIT LIMITED WRITTEN WARRANTIES ISSUED TO AND ACCEPTED BY BUILDING OWNERS IN ACCORDANCE WITH STO'S WARRANTY PROGRAMS WHICH ARE SUBJECT TO CHANGE FROM TIME TO TIME. For the fullest, most current information on proper application, clean-up, mixing and other specifications and warranties, cautions and disclaimers, please refer to the Sto Corp. website. [www.stocorp.com](http://www.stocorp.com)

[www.stocorp.com](http://www.stocorp.com)



# StoTherm® ci

## Termination at Grade - Sheathing Flush with Foundation or Slab Edge

Detail No.: 52s.03A  
Date: June 2022

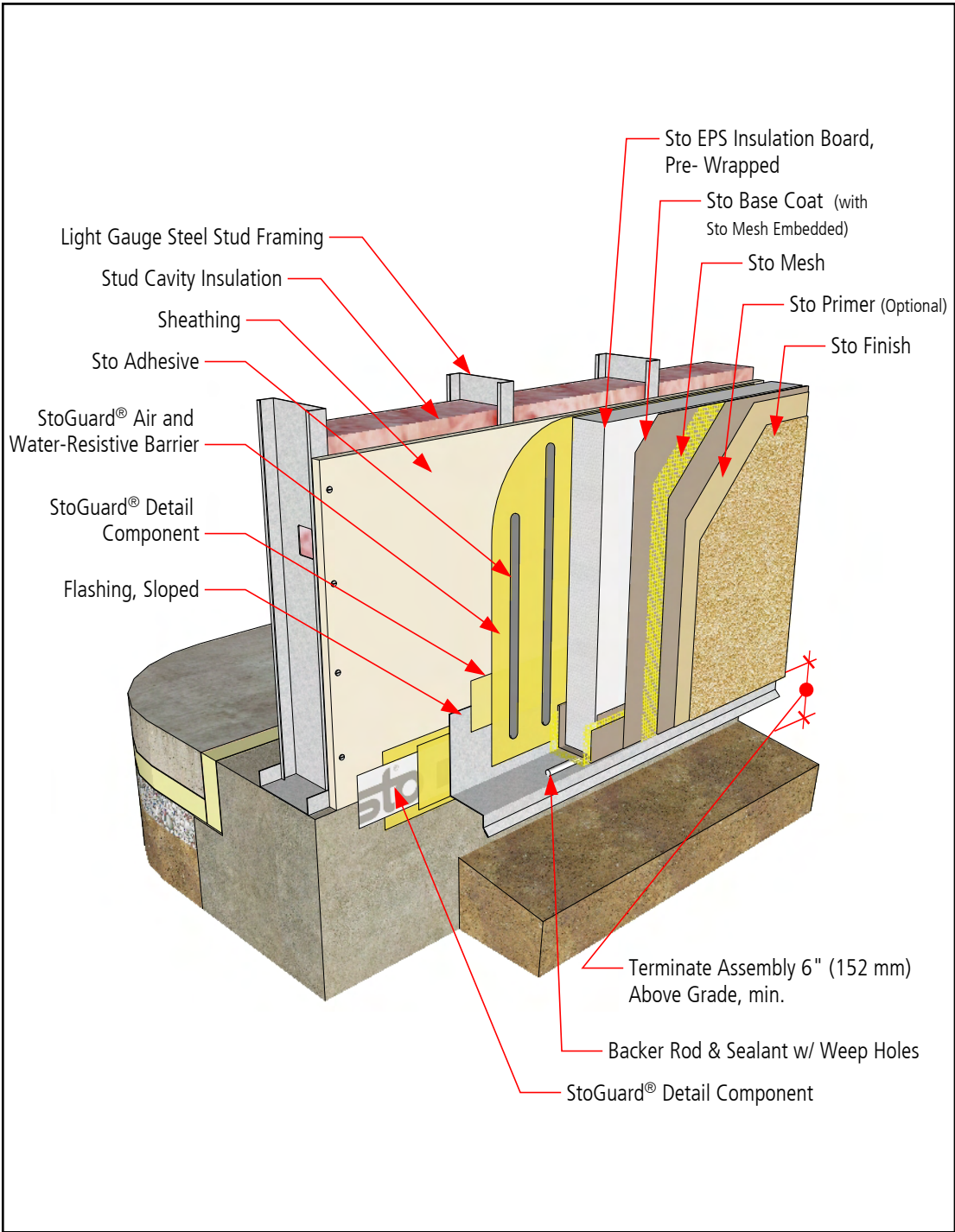

- Notes:
1. Refer to StoGuard Product Use Chart (Table 1.1) for StoGuard detail components; joint treatment, rough opening protection, backing for masonry anchors, or transitions to dissimilar materials, joints and seams in construction.
  2. Refer to General Notes for specific information and design guidance on wall assembly components.
  3. Components not identified as Sto are furnished by other manufacturers and are not necessarily installed by trades who install the Sto products. Refer to project specific contract documents.

**ATTENTION**

Property of Sto Corp. All Rights Reserved

[www.stocorp.com](http://www.stocorp.com)

Sto products are intended for use by qualified professional contractors, not consumers, as a component of a larger construction assembly as specified by a qualified design professional, general contractor or builder. They should be installed in accordance with those specifications and Sto's instructions. Sto Corp. disclaims all, and assumes no, liability for on-site inspections, for its products applied improperly, or by unqualified persons or entities, or as part of an improperly designed or constructed building, for the nonperformance of adjacent building components or assemblies, or for other construction activities beyond Sto's control. Improper use of Sto products or use as part of an improperly designed or constructed larger assembly or building may result in serious damage to Sto products, and to the structure of the building or its components.

STO CORP. DISCLAIMS ALL WARRANTIES EXPRESSED OR IMPLIED EXCEPT FOR EXPLICIT LIMITED WRITTEN WARRANTIES ISSUED TO AND ACCEPTED BY BUILDING OWNERS IN ACCORDANCE WITH STO'S WARRANTY PROGRAMS WHICH ARE SUBJECT TO CHANGE FROM TIME TO TIME. For the fullest, most current information on proper application, clean-up, mixing and other specifications and warranties, cautions and disclaimers, please refer to the Sto Corp. website. [www.stocorp.com](http://www.stocorp.com)



# StoTherm® ci

## Termination at Grade - Sheathing Overlapping Slab or Foundation

Detail No.: 52s.03B  
Date: June 2022

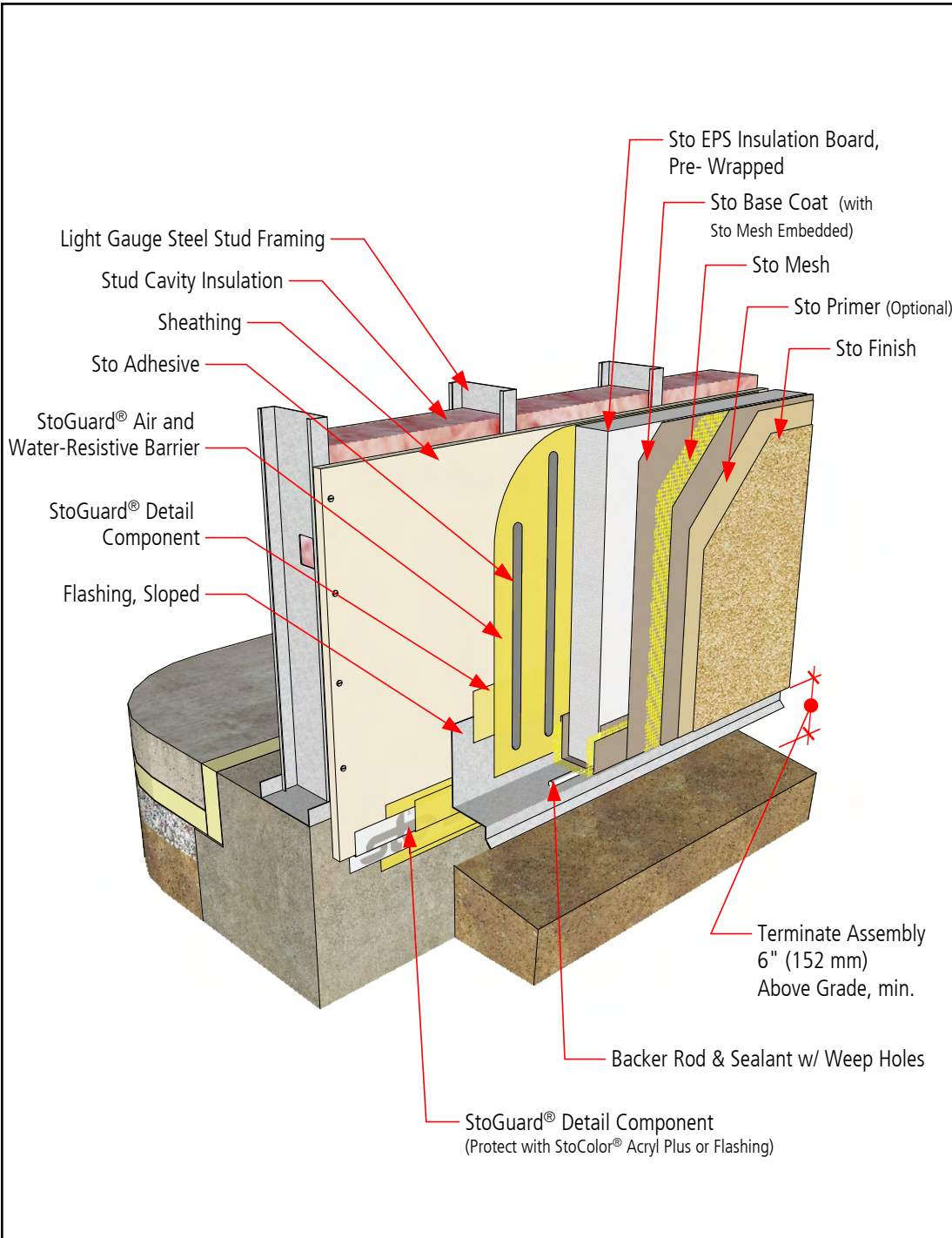

### Notes:

1. Refer to StoGuard Product Use Chart (Table 1.1) for StoGuard detail components; joint treatment, rough opening protection, backing for masonry anchors, or transitions to dissimilar materials, joints and seams in construction.
2. Refer to General Notes for specific information and design guidance on wall assembly components.
3. Components not identified as Sto are furnished by other manufacturers and are not necessarily installed by trades who install the Sto products. Refer to project specific contract documents.

### ATTENTION

Property of Sto Corp. All Rights Reserved

Sto products are intended for use by qualified professional contractors, not consumers, as a component of a larger construction assembly as specified by a qualified design professional, general contractor or builder. They should be installed in accordance with those specifications and Sto's instructions. Sto Corp. disclaims all, and assumes no, liability for on-site inspections, for its products applied improperly, or by unqualified persons or entities, or as part of an improperly designed or constructed building, for the nonperformance of adjacent building components or assemblies, or for other construction activities beyond Sto's control. Improper use of Sto products or use as part of an improperly designed or constructed larger assembly or building may result in serious damage to Sto products, and to the structure of the building or its components.

STO CORP. DISCLAIMS ALL WARRANTIES EXPRESSED OR IMPLIED EXCEPT FOR EXPLICIT LIMITED WRITTEN WARRANTIES ISSUED TO AND ACCEPTED BY BUILDING OWNERS IN ACCORDANCE WITH STO'S WARRANTY PROGRAMS WHICH ARE SUBJECT TO CHANGE FROM TIME TO TIME. For the fullest, most current information on proper application, clean-up, mixing and other specifications and warranties, cautions and disclaimers, please refer to the Sto Corp. website. [www.stocorp.com](http://www.stocorp.com)

[www.stocorp.com](http://www.stocorp.com)



# StoTherm® ci Aesthetic Feature Band

Detail No.: 52s.04  
Date: June 2022

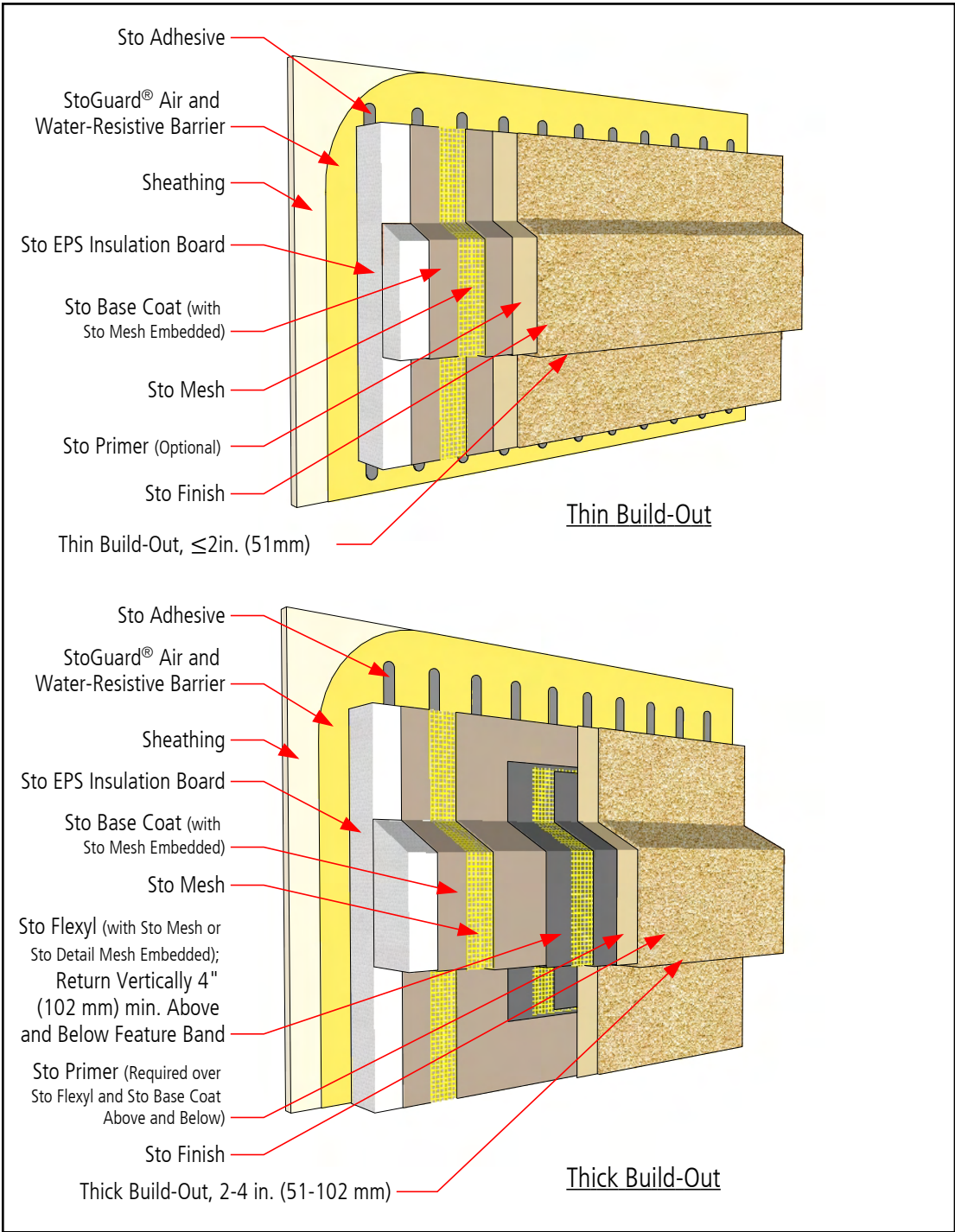

- Notes:
1. Refer to StoGuard Product Use Chart (Table 1.1) for StoGuard detail components; joint treatment, rough opening protection, backing for masonry anchors, or transitions to dissimilar materials, joints and seams in construction.
  2. Refer to General Notes for specific information and design guidance on wall assembly components.
  3. Components not identified as Sto are furnished by other manufacturers and are not necessarily installed by trades who install the Sto products. Refer to project specific contract documents.

**ATTENTION**

Property of Sto Corp. All Rights Reserved

[www.stocorp.com](http://www.stocorp.com)

Sto products are intended for use by qualified professional contractors, not consumers, as a component of a larger construction assembly as specified by a qualified design professional, general contractor or builder. They should be installed in accordance with those specifications and Sto's instructions. Sto Corp. disclaims all, and assumes no, liability for on-site inspections, for its products applied improperly, or by unqualified persons or entities, or as part of an improperly designed or constructed building, for the nonperformance of adjacent building components or assemblies, or for other construction activities beyond Sto's control. Improper use of Sto products or use as part of an improperly designed or constructed larger assembly or building may result in serious damage to Sto products, and to the structure of the building or its components.

STO CORP. DISCLAIMS ALL WARRANTIES EXPRESSED OR IMPLIED EXCEPT FOR EXPLICIT LIMITED WRITTEN WARRANTIES ISSUED TO AND ACCEPTED BY BUILDING OWNERS IN ACCORDANCE WITH STO'S WARRANTY PROGRAMS WHICH ARE SUBJECT TO CHANGE FROM TIME TO TIME. For the fullest, most current information on proper application, clean-up, mixing and other specifications and warranties, cautions and disclaimers, please refer to the Sto Corp. website. [www.stocorp.com](http://www.stocorp.com)



# StoTherm® ci Aesthetic Reveal

Detail No.: 52s.05  
Date: June 2022

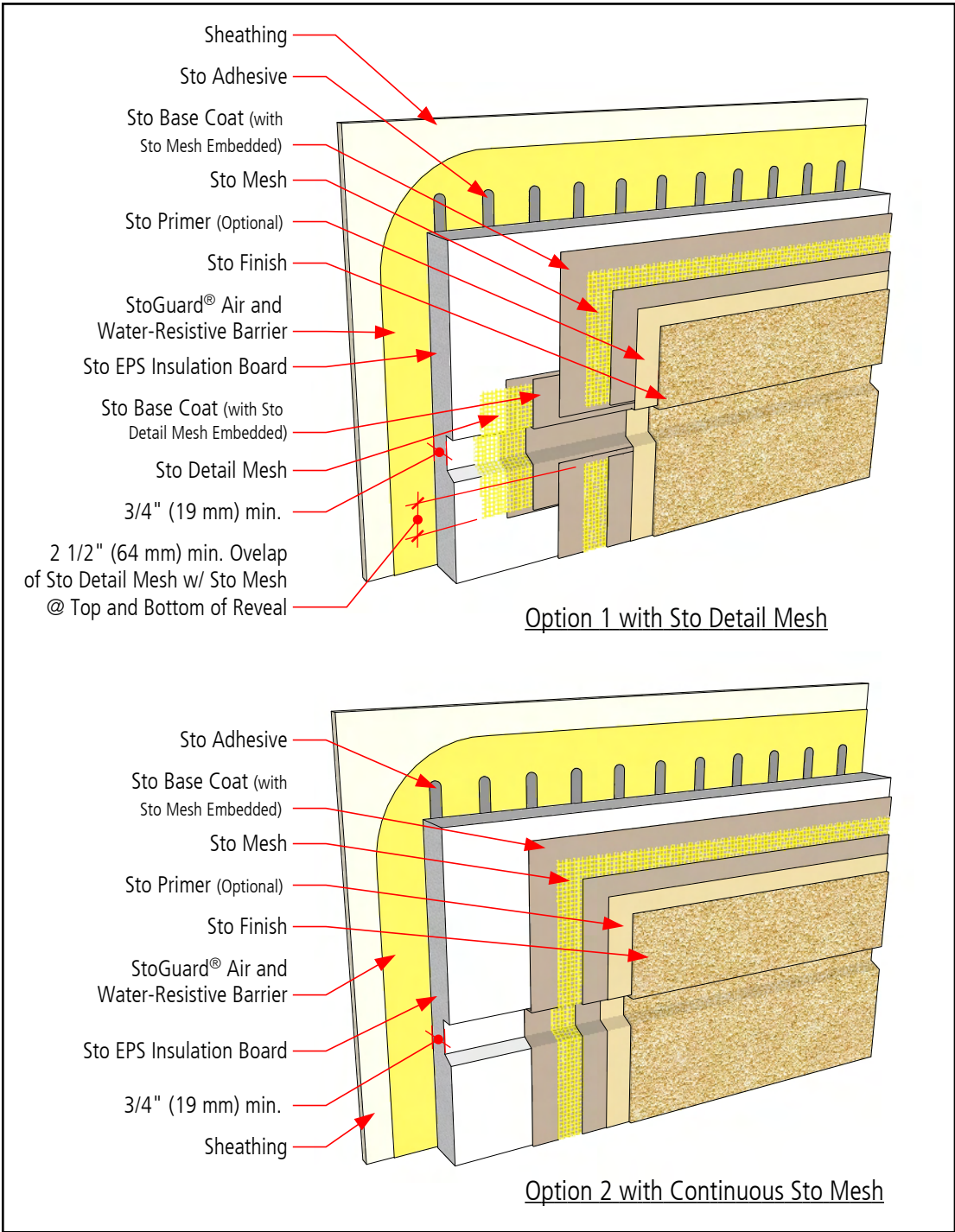

Notes:

1. Refer to StoGuard Product Use Chart (Table 1.1) for StoGuard detail components; joint treatment, rough opening protection, backing for masonry anchors, or transitions to dissimilar materials, joints and seams in construction.
2. Refer to General Notes for specific information and design guidance on wall assembly components.
3. Components not identified as Sto are furnished by other manufacturers and are not necessarily installed by trades who install the Sto products. Refer to project specific contract documents.

**ATTENTION**

Property of Sto Corp. All Rights Reserved

[www.stocorp.com](http://www.stocorp.com)

Sto products are intended for use by qualified professional contractors, not consumers, as a component of a larger construction assembly as specified by a qualified design professional, general contractor or builder. They should be installed in accordance with those specifications and Sto's instructions. Sto Corp. disclaims all, and assumes no, liability for on-site inspections, for its products applied improperly, or by unqualified persons or entities, or as part of an improperly designed or constructed building, for the nonperformance of adjacent building components or assemblies, or for other construction activities beyond Sto's control. Improper use of Sto products or use as part of an improperly designed or constructed larger assembly or building may result in serious damage to Sto products, and to the structure of the building or its components.

STO CORP. DISCLAIMS ALL WARRANTIES EXPRESSED OR IMPLIED EXCEPT FOR EXPLICIT LIMITED WRITTEN WARRANTIES ISSUED TO AND ACCEPTED BY BUILDING OWNERS IN ACCORDANCE WITH STO'S WARRANTY PROGRAMS WHICH ARE SUBJECT TO CHANGE FROM TIME TO TIME. For the fullest, most current information on proper application, clean-up, mixing and other specifications and warranties, cautions and disclaimers, please refer to the Sto Corp. website. [www.stocorp.com](http://www.stocorp.com)



# StoTherm® ci Receptor-Type Window Sill

Detail No.: 52s.23A-1  
Date: June 2022

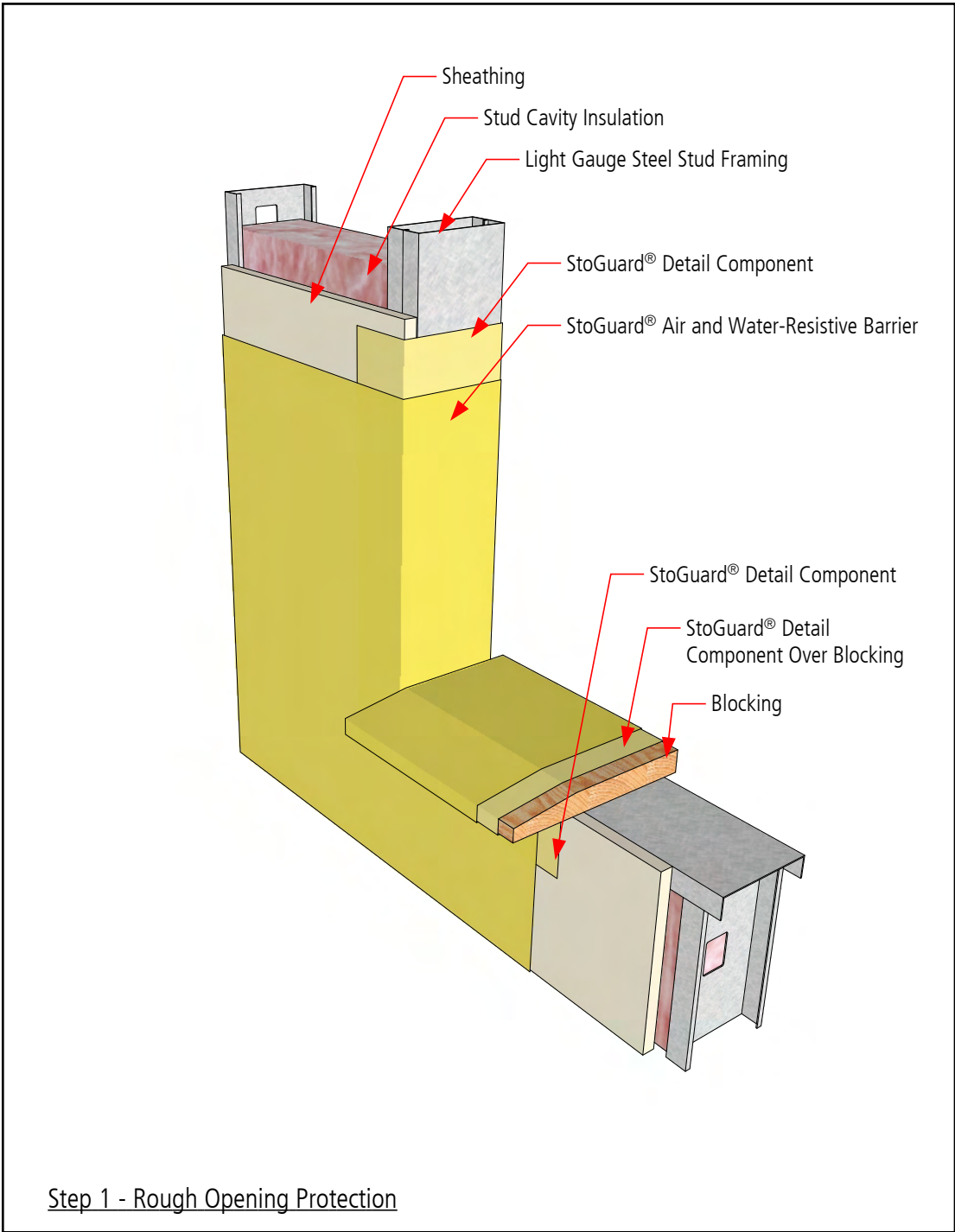

- Notes:
1. Refer to StoGuard Product Use Chart (Table 1.1) for StoGuard detail components; joint treatment, rough opening protection, backing for masonry anchors, or transitions to dissimilar materials, joints and seams in construction.
  2. Refer to General Notes for specific information and design guidance on wall assembly components.
  3. Components not identified as Sto are furnished by other manufacturers and are not necessarily installed by trades who install the Sto products. Refer to project specific contract documents.

Step 1 - Rough Opening Protection

**ATTENTION**

Property of Sto Corp. All Rights Reserved

Sto products are intended for use by qualified professional contractors, not consumers, as a component of a larger construction assembly as specified by a qualified design professional, general contractor or builder. They should be installed in accordance with those specifications and Sto's instructions. Sto Corp. disclaims all, and assumes no, liability for on-site inspections, for its products applied improperly, or by unqualified persons or entities, or as part of an improperly designed or constructed building, for the nonperformance of adjacent building components or assemblies, or for other construction activities beyond Sto's control. Improper use of Sto products or use as part of an improperly designed or constructed larger assembly or building may result in serious damage to Sto products, and to the structure of the building or its components.

STO CORP. DISCLAIMS ALL WARRANTIES EXPRESSED OR IMPLIED EXCEPT FOR EXPLICIT LIMITED WRITTEN WARRANTIES ISSUED TO AND ACCEPTED BY BUILDING OWNERS IN ACCORDANCE WITH STO'S WARRANTY PROGRAMS WHICH ARE SUBJECT TO CHANGE FROM TIME TO TIME. For the fullest, most current information on proper application, clean-up, mixing and other specifications and warranties, cautions and disclaimers, please refer to the Sto Corp. website. [www.stocorp.com](http://www.stocorp.com)

[www.stocorp.com](http://www.stocorp.com)



# StoTherm® ci Receptor-Type Window Sill

Detail No.: 52s.23A-2  
Date: June 2022

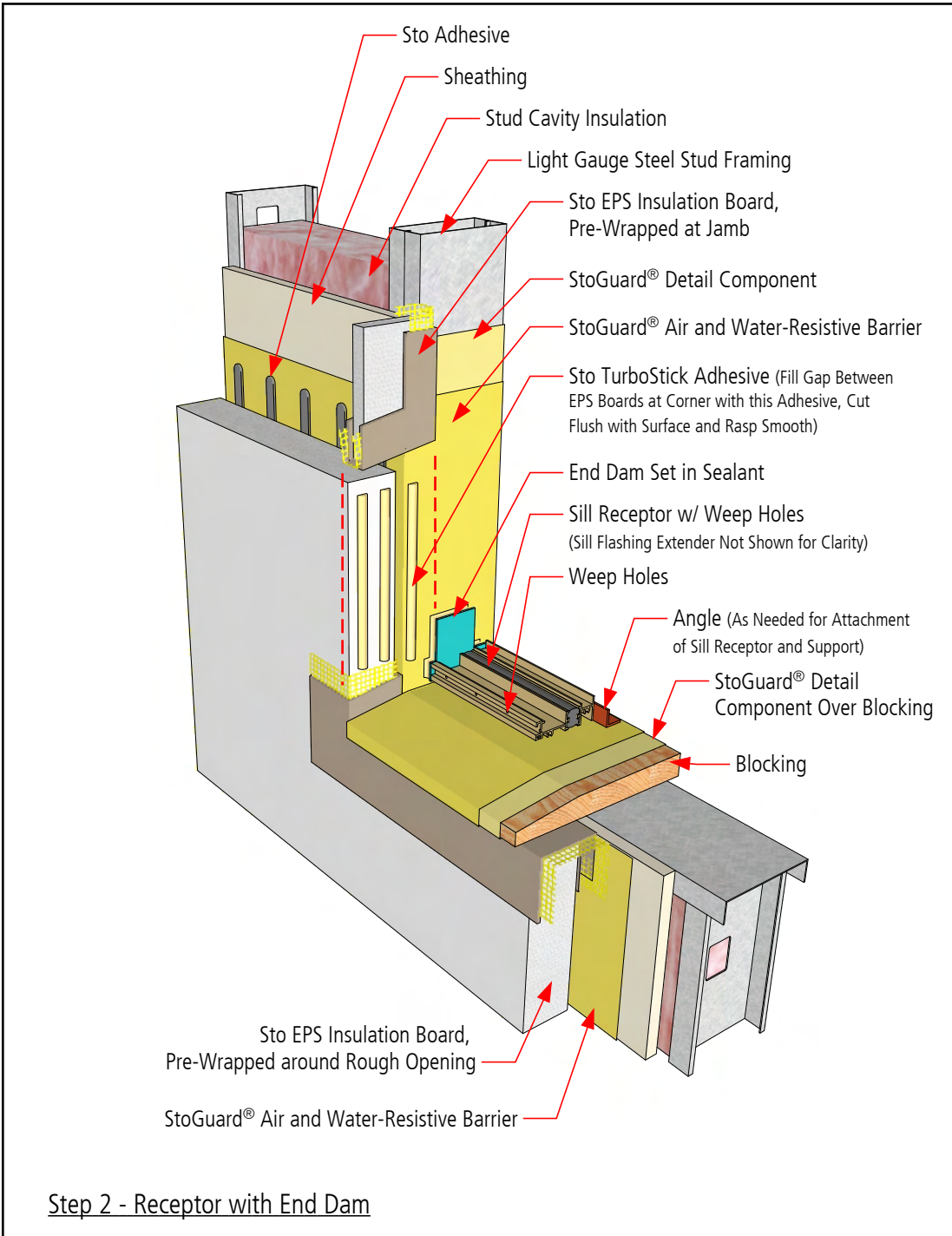

- Notes:
1. Refer to StoGuard Product Use Chart (Table 1.1) for StoGuard detail components; joint treatment, rough opening protection, backing for masonry anchors, or transitions to dissimilar materials, joints and seams in construction.
  2. Refer to General Notes for specific information and design guidance on wall assembly components.
  3. Components not identified as Sto are furnished by other manufacturers and are not necessarily installed by trades who install the Sto products. Refer to project specific contract documents.

**ATTENTION**

Property of Sto Corp. All Rights Reserved

[www.stocorp.com](http://www.stocorp.com)

Sto products are intended for use by qualified professional contractors, not consumers, as a component of a larger construction assembly as specified by a qualified design professional, general contractor or builder. They should be installed in accordance with those specifications and Sto's instructions. Sto Corp. disclaims all, and assumes no, liability for on-site inspections, for its products applied improperly, or by unqualified persons or entities, or as part of an improperly designed or constructed building, for the nonperformance of adjacent building components or assemblies, or for other construction activities beyond Sto's control. Improper use of Sto products or use as part of an improperly designed or constructed larger assembly or building may result in serious damage to Sto products, and to the structure of the building or its components.

STO CORP. DISCLAIMS ALL WARRANTIES EXPRESSED OR IMPLIED EXCEPT FOR EXPLICIT LIMITED WRITTEN WARRANTIES ISSUED TO AND ACCEPTED BY BUILDING OWNERS IN ACCORDANCE WITH STO'S WARRANTY PROGRAMS WHICH ARE SUBJECT TO CHANGE FROM TIME TO TIME. For the fullest, most current information on proper application, clean-up, mixing and other specifications and warranties, cautions and disclaimers, please refer to the Sto Corp. website. [www.stocorp.com](http://www.stocorp.com)





# StoTherm® ci Receptor-Type Window Sill

Detail No.: 52s.23A-3  
Date: June 2022

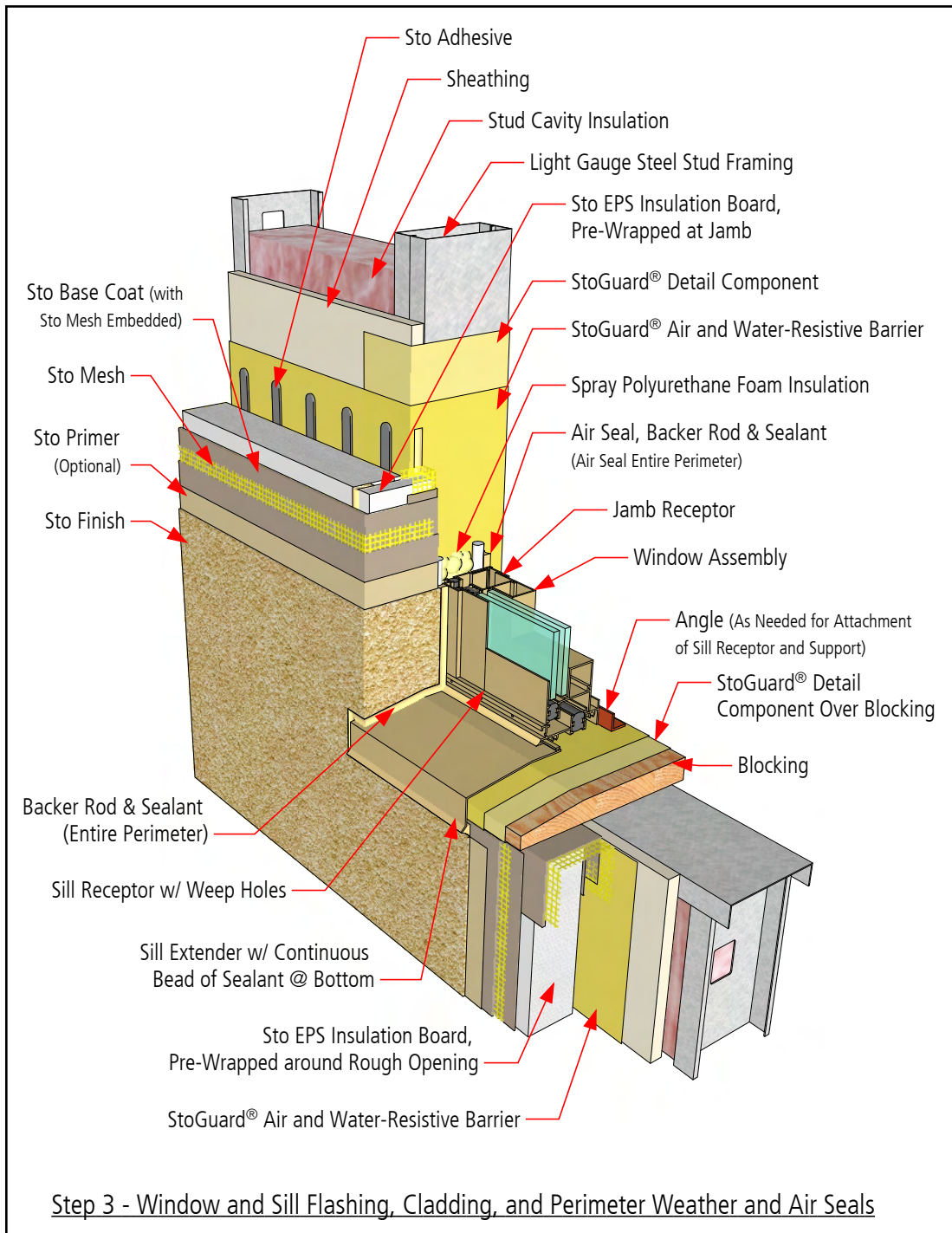

## Notes:

1. Refer to StoGuard Product Use Chart (Table 1.1) for StoGuard detail components; joint treatment, rough opening protection, backing for masonry anchors, or transitions to dissimilar materials, joints and seams in construction.
2. Refer to General Notes for specific information and design guidance on wall assembly components.
3. Components not identified as Sto are furnished by other manufacturers and are not necessarily installed by trades who install the Sto products. Refer to project specific contract documents.

## ATTENTION

Property of Sto Corp. All Rights Reserved

Sto products are intended for use by qualified professional contractors, not consumers, as a component of a larger construction assembly as specified by a qualified design professional, general contractor or builder. They should be installed in accordance with those specifications and Sto's instructions. Sto Corp. disclaims all, and assumes no, liability for on-site inspections, for its products applied improperly, or by unqualified persons or entities, or as part of an improperly designed or constructed building, for the nonperformance of adjacent building components or assemblies, or for other construction activities beyond Sto's control. Improper use of Sto products or use as part of an improperly designed or constructed larger assembly or building may result in serious damage to Sto products, and to the structure of the building or its components.

**STO CORP. DISCLAIMS ALL WARRANTIES EXPRESSED OR IMPLIED EXCEPT FOR EXPLICIT LIMITED WRITTEN WARRANTIES ISSUED TO AND ACCEPTED BY BUILDING OWNERS IN ACCORDANCE WITH STO'S WARRANTY PROGRAMS WHICH ARE SUBJECT TO CHANGE FROM TIME TO TIME.** For the fullest, most current information on proper application, clean-up, mixing and other specifications and warranties, cautions and disclaimers, please refer to the Sto Corp. website. [www.stocorp.com](http://www.stocorp.com)

[www.stocorp.com](http://www.stocorp.com)



# StoTherm® ci Receptor-Type Window Head

Detail No.: 52s.23B-1  
Date: June 2022

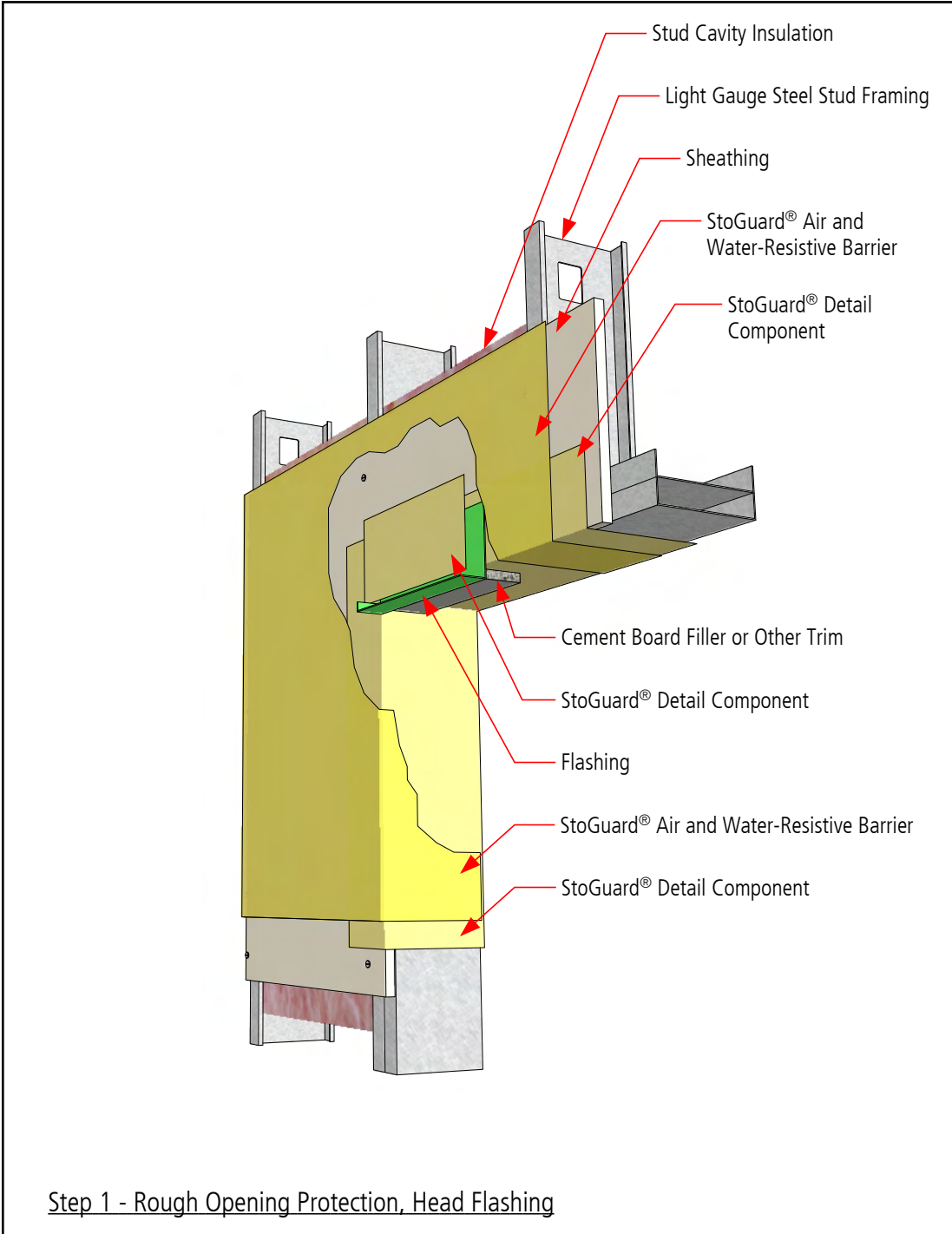

- Notes:
1. Refer to StoGuard Product Use Chart (Table 1.1) for StoGuard detail components; joint treatment, rough opening protection, backing for masonry anchors, or transitions to dissimilar materials, joints and seams in construction.
  2. Refer to General Notes for specific information and design guidance on wall assembly components.
  3. Components not identified as Sto are furnished by other manufacturers and are not necessarily installed by trades who install the Sto products. Refer to project specific contract documents.

**ATTENTION**

Property of Sto Corp. All Rights Reserved

Sto products are intended for use by qualified professional contractors, not consumers, as a component of a larger construction assembly as specified by a qualified design professional, general contractor or builder. They should be installed in accordance with those specifications and Sto's instructions. Sto Corp. disclaims all, and assumes no, liability for on-site inspections, for its products applied improperly, or by unqualified persons or entities, or as part of an improperly designed or constructed building, for the nonperformance of adjacent building components or assemblies, or for other construction activities beyond Sto's control. Improper use of Sto products or use as part of an improperly designed or constructed larger assembly or building may result in serious damage to Sto products, and to the structure of the building or its components.

STO CORP. DISCLAIMS ALL WARRANTIES EXPRESSED OR IMPLIED EXCEPT FOR EXPLICIT LIMITED WRITTEN WARRANTIES ISSUED TO AND ACCEPTED BY BUILDING OWNERS IN ACCORDANCE WITH STO'S WARRANTY PROGRAMS WHICH ARE SUBJECT TO CHANGE FROM TIME TO TIME. For the fullest, most current information on proper application, clean-up, mixing and other specifications and warranties, cautions and disclaimers, please refer to the Sto Corp. website. [www.stocorp.com](http://www.stocorp.com)

[www.stocorp.com](http://www.stocorp.com)



# StoTherm® ci Receptor-Type Window Head

Detail No.: 52s.23B-2  
Date: June 2022

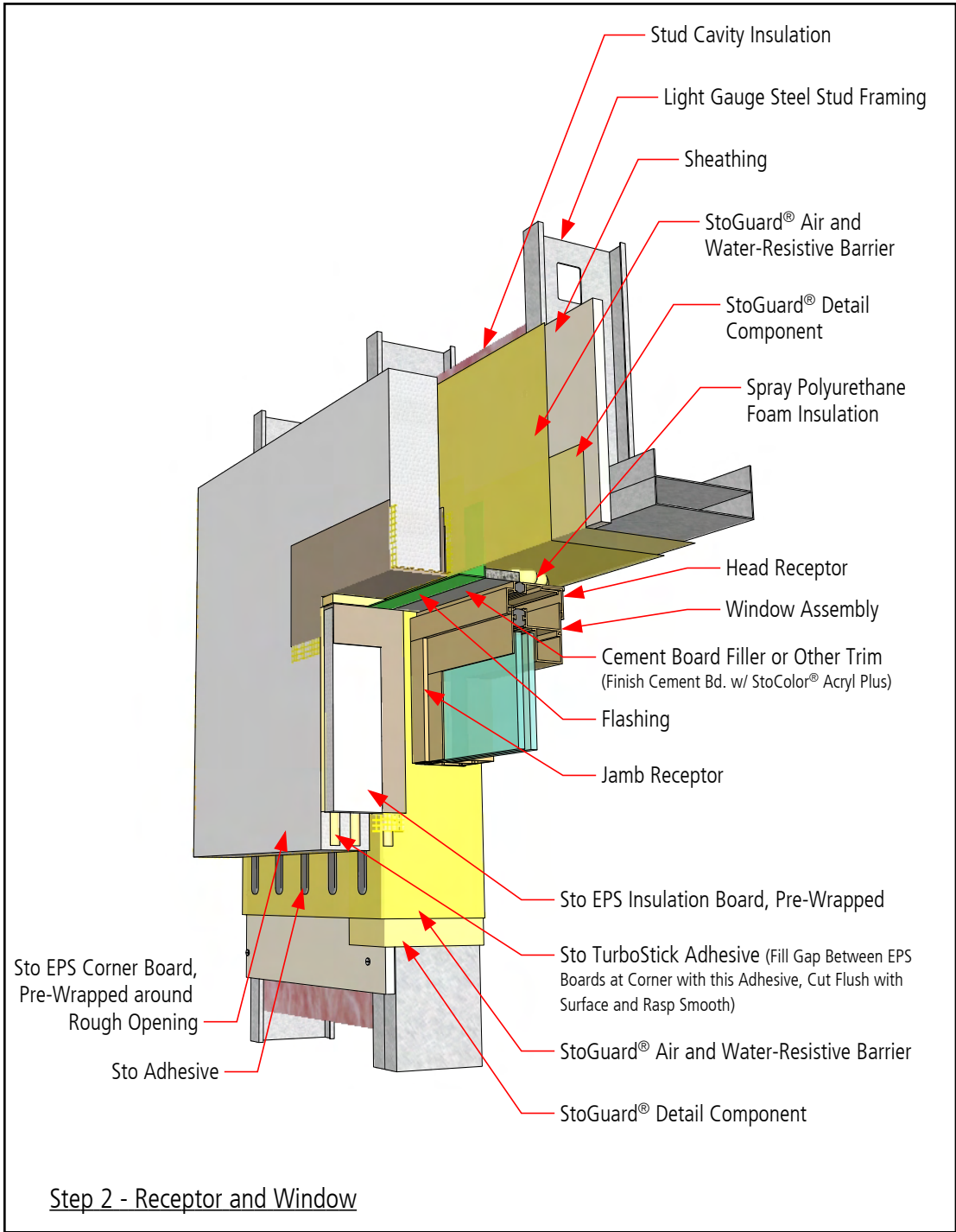

- Notes:
1. Refer to StoGuard Product Use Chart (Table 1.1) for StoGuard detail components; joint treatment, rough opening protection, backing for masonry anchors, or transitions to dissimilar materials, joints and seams in construction.
  2. Refer to General Notes for specific information and design guidance on wall assembly components.
  3. Components not identified as Sto are furnished by other manufacturers and are not necessarily installed by trades who install the Sto products. Refer to project specific contract documents.

**ATTENTION**

Property of Sto Corp. All Rights Reserved

[www.stocorp.com](http://www.stocorp.com)

Sto products are intended for use by qualified professional contractors, not consumers, as a component of a larger construction assembly as specified by a qualified design professional, general contractor or builder. They should be installed in accordance with those specifications and Sto's instructions. Sto Corp. disclaims all, and assumes no, liability for on-site inspections, for its products applied improperly, or by unqualified persons or entities, or as part of an improperly designed or constructed building, for the nonperformance of adjacent building components or assemblies, or for other construction activities beyond Sto's control. Improper use of Sto products or use as part of an improperly designed or constructed larger assembly or building may result in serious damage to Sto products, and to the structure of the building or its components.

STO CORP. DISCLAIMS ALL WARRANTIES EXPRESSED OR IMPLIED EXCEPT FOR EXPLICIT LIMITED WRITTEN WARRANTIES ISSUED TO AND ACCEPTED BY BUILDING OWNERS IN ACCORDANCE WITH STO'S WARRANTY PROGRAMS WHICH ARE SUBJECT TO CHANGE FROM TIME TO TIME. For the fullest, most current information on proper application, clean-up, mixing and other specifications and warranties, cautions and disclaimers, please refer to the Sto Corp. website. [www.stocorp.com](http://www.stocorp.com)



# StoTherm® ci Receptor-Type Window Head

Detail No.: 52s.23B-3  
Date: June 2022

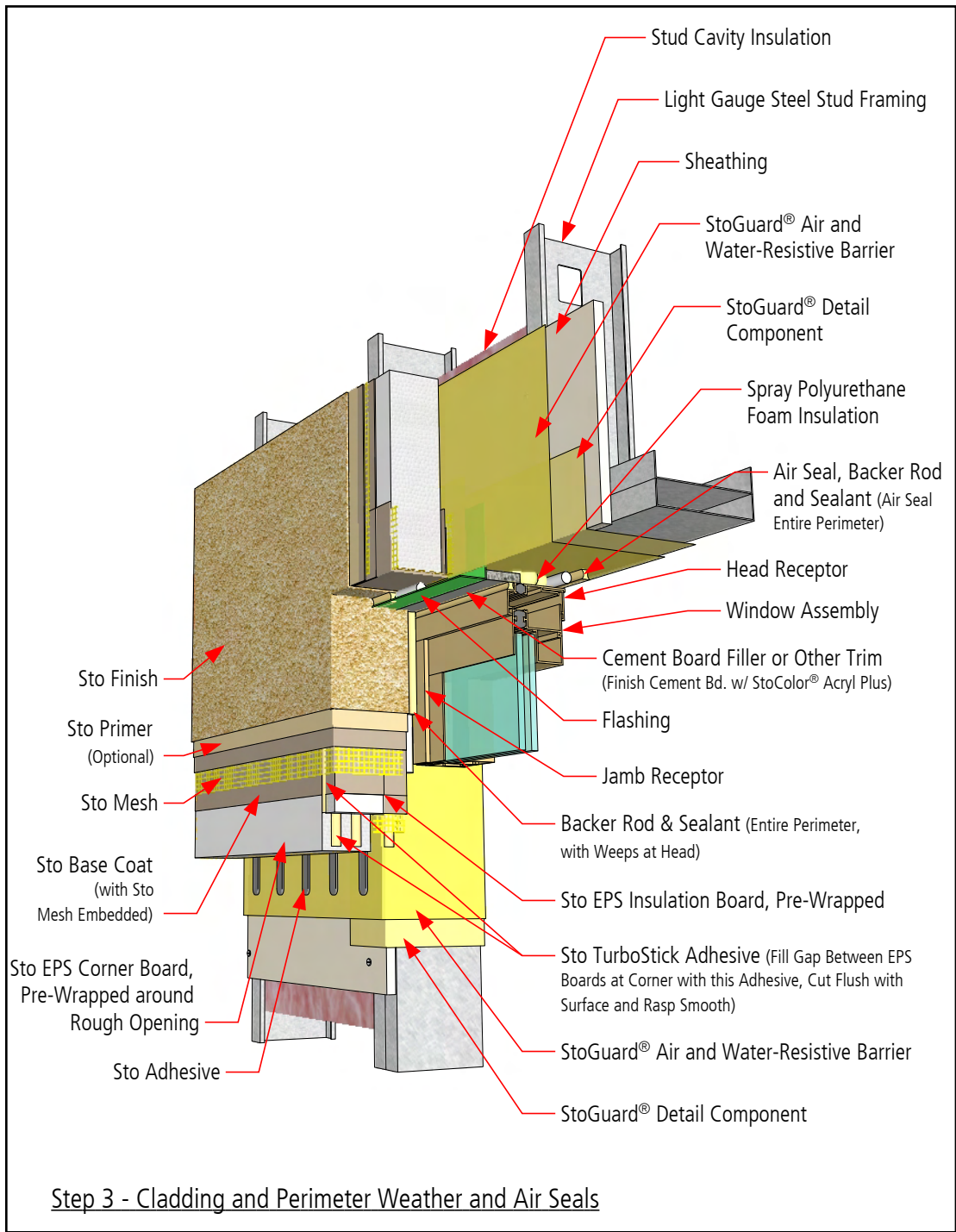

- Notes:
1. Refer to StoGuard Product Use Chart (Table 1.1) for StoGuard detail components; joint treatment, rough opening protection, backing for masonry anchors, or transitions to dissimilar materials, joints and seams in construction.
  2. Refer to General Notes for specific information and design guidance on wall assembly components.
  3. Components not identified as Sto are furnished by other manufacturers and are not necessarily installed by trades who install the Sto products. Refer to project specific contract documents.

**ATTENTION**

Property of Sto Corp. All Rights Reserved

[www.stocorp.com](http://www.stocorp.com)

Sto products are intended for use by qualified professional contractors, not consumers, as a component of a larger construction assembly as specified by a qualified design professional, general contractor or builder. They should be installed in accordance with those specifications and Sto's instructions. Sto Corp. disclaims all, and assumes no, liability for on-site inspections, for its products applied improperly, or by unqualified persons or entities, or as part of an improperly designed or constructed building, for the nonperformance of adjacent building components or assemblies, or for other construction activities beyond Sto's control. Improper use of Sto products or use as part of an improperly designed or constructed larger assembly or building may result in serious damage to Sto products, and to the structure of the building or its components.

STO CORP. DISCLAIMS ALL WARRANTIES EXPRESSED OR IMPLIED EXCEPT FOR EXPLICIT LIMITED WRITTEN WARRANTIES ISSUED TO AND ACCEPTED BY BUILDING OWNERS IN ACCORDANCE WITH STO'S WARRANTY PROGRAMS WHICH ARE SUBJECT TO CHANGE FROM TIME TO TIME. For the fullest, most current information on proper application, clean-up, mixing and other specifications and warranties, cautions and disclaimers, please refer to the Sto Corp. website. [www.stocorp.com](http://www.stocorp.com)



# StoTherm® ci Flanged Window-Sill

Detail No.: 52s.24A-1  
Date: June 2022

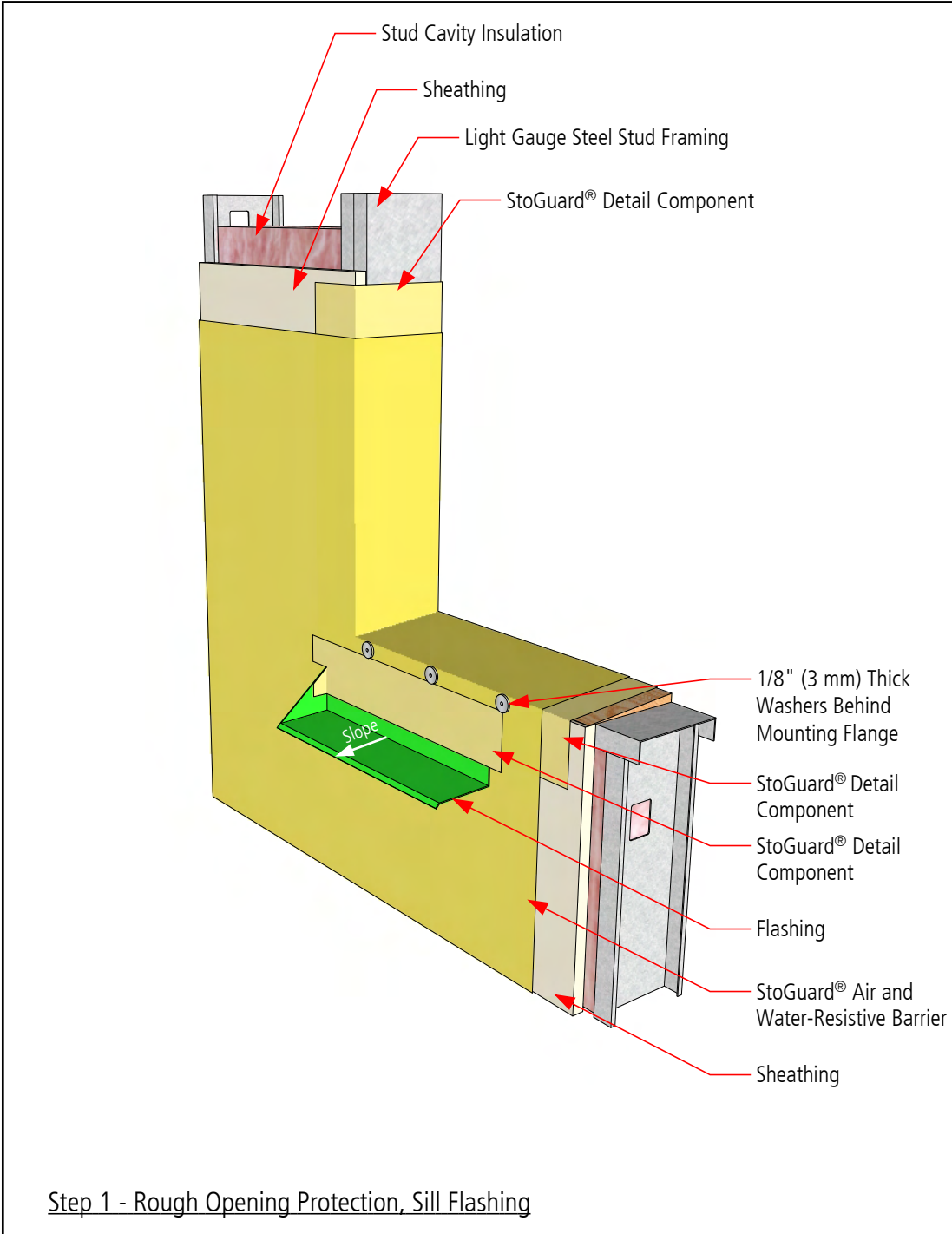

Notes:

1. Refer to StoGuard Product Use Chart (Table 1.1) for StoGuard detail components; joint treatment, rough opening protection, backing for masonry anchors, or transitions to dissimilar materials, joints and seams in construction.
2. Refer to General Notes for specific information and design guidance on wall assembly components.
3. Components not identified as Sto are furnished by other manufacturers and are not necessarily installed by trades who install the Sto products. Refer to project specific contract documents.

**ATTENTION**

Property of Sto Corp. All Rights Reserved

Sto products are intended for use by qualified professional contractors, not consumers, as a component of a larger construction assembly as specified by a qualified design professional, general contractor or builder. They should be installed in accordance with those specifications and Sto's instructions. Sto Corp. disclaims all, and assumes no, liability for on-site inspections, for its products applied improperly, or by unqualified persons or entities, or as part of an improperly designed or constructed building, for the nonperformance of adjacent building components or assemblies, or for other construction activities beyond Sto's control. Improper use of Sto products or use as part of an improperly designed or constructed larger assembly or building may result in serious damage to Sto products, and to the structure of the building or its components.

STO CORP. DISCLAIMS ALL WARRANTIES EXPRESSED OR IMPLIED EXCEPT FOR EXPLICIT LIMITED WRITTEN WARRANTIES ISSUED TO AND ACCEPTED BY BUILDING OWNERS IN ACCORDANCE WITH STO'S WARRANTY PROGRAMS WHICH ARE SUBJECT TO CHANGE FROM TIME TO TIME. For the fullest, most current information on proper application, clean-up, mixing and other specifications and warranties, cautions and disclaimers, please refer to the Sto Corp. website. [www.stocorp.com](http://www.stocorp.com)

[www.stocorp.com](http://www.stocorp.com)



# StoTherm® ci Flanged Window-Sill

Detail No.: 52s.24A-2  
Date: June 2022

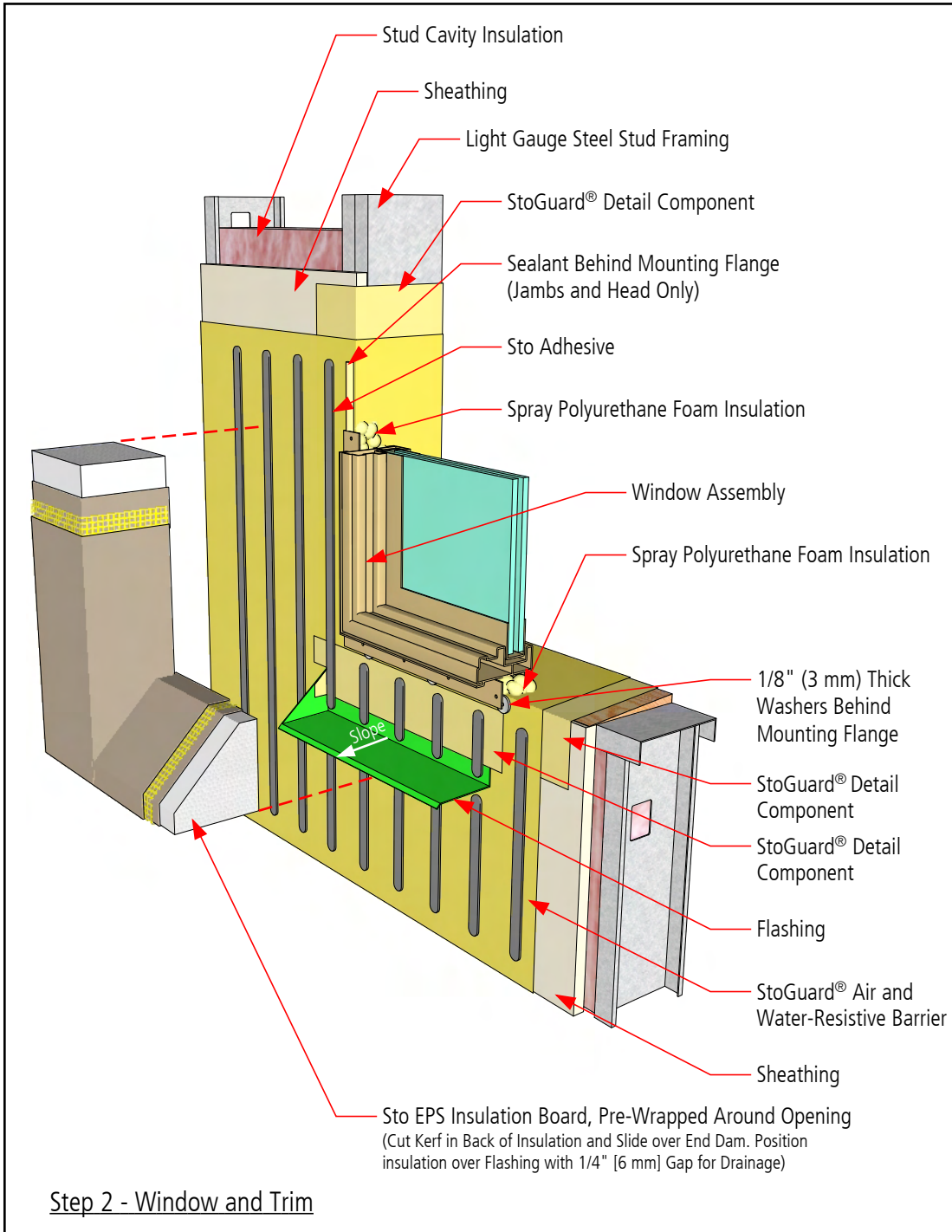

- Notes:
1. Refer to StoGuard Product Use Chart (Table 1.1) for StoGuard detail components; joint treatment, rough opening protection, backing for masonry anchors, or transitions to dissimilar materials, joints and seams in construction.
  2. Refer to General Notes for specific information and design guidance on wall assembly components.
  3. Components not identified as Sto are furnished by other manufacturers and are not necessarily installed by trades who install the Sto products. Refer to project specific contract documents.

**ATTENTION**

Property of Sto Corp. All Rights Reserved

[www.stocorp.com](http://www.stocorp.com)

Sto products are intended for use by qualified professional contractors, not consumers, as a component of a larger construction assembly as specified by a qualified design professional, general contractor or builder. They should be installed in accordance with those specifications and Sto's instructions. Sto Corp. disclaims all, and assumes no, liability for on-site inspections, for its products applied improperly, or by unqualified persons or entities, or as part of an improperly designed or constructed building, for the nonperformance of adjacent building components or assemblies, or for other construction activities beyond Sto's control. Improper use of Sto products or use as part of an improperly designed or constructed larger assembly or building may result in serious damage to Sto products, and to the structure of the building or its components.

STO CORP. DISCLAIMS ALL WARRANTIES EXPRESSED OR IMPLIED EXCEPT FOR EXPLICIT LIMITED WRITTEN WARRANTIES ISSUED TO AND ACCEPTED BY BUILDING OWNERS IN ACCORDANCE WITH STO'S WARRANTY PROGRAMS WHICH ARE SUBJECT TO CHANGE FROM TIME TO TIME. For the fullest, most current information on proper application, clean-up, mixing and other specifications and warranties, cautions and disclaimers, please refer to the Sto Corp. website. [www.stocorp.com](http://www.stocorp.com)



# StoTherm® ci Flanged Window-Sill

Detail No.: 52s.24A-3  
Date: June 2022

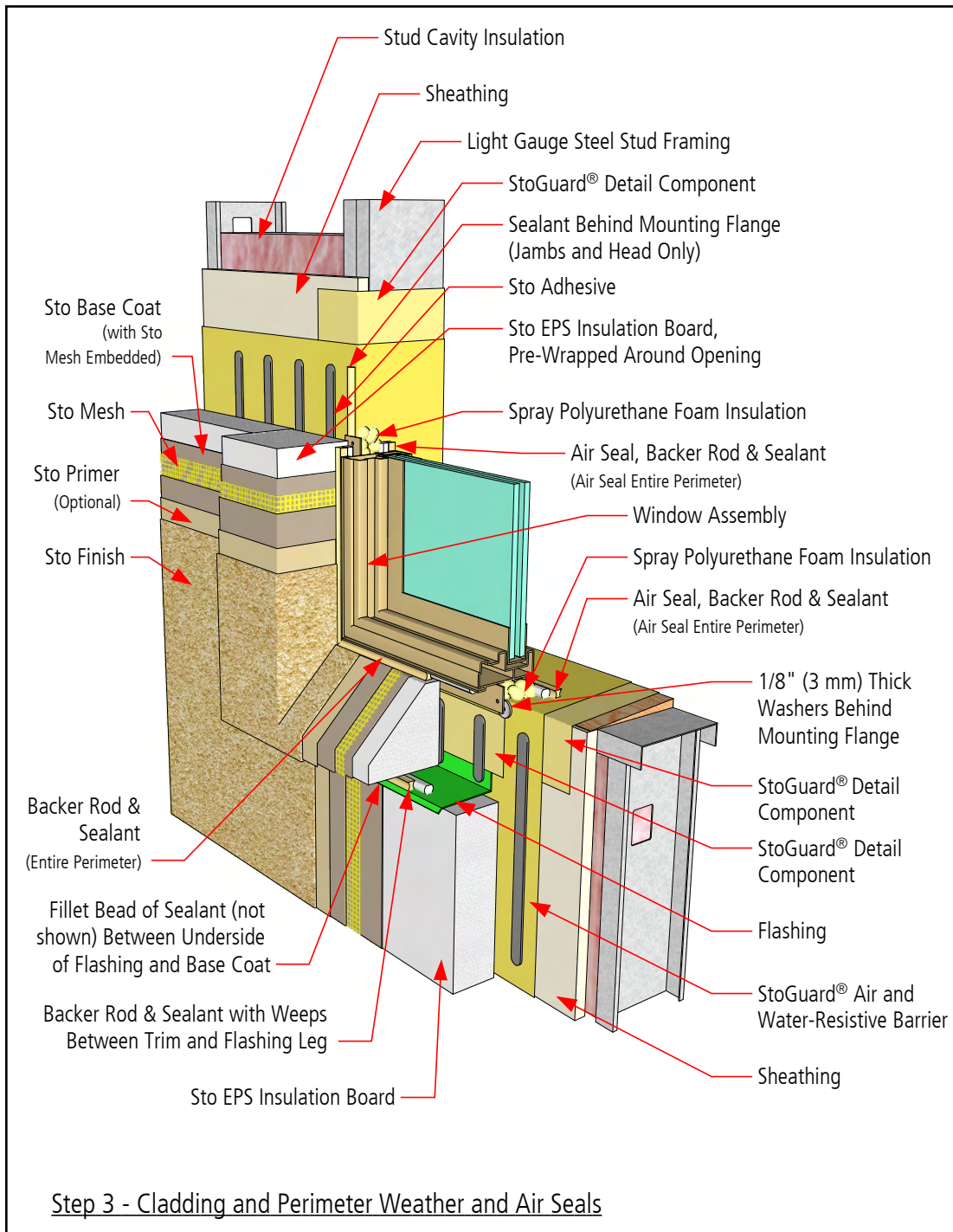

- Notes:
1. Refer to StoGuard Product Use Chart (Table 1.1) for StoGuard detail components; joint treatment, rough opening protection, backing for masonry anchors, or transitions to dissimilar materials, joints and seams in construction.
  2. Refer to General Notes for specific information and design guidance on wall assembly components.
  3. Components not identified as Sto are furnished by other manufacturers and are not necessarily installed by trades who install the Sto products. Refer to project specific contract documents.

**ATTENTION**

Property of Sto Corp. All Rights Reserved

[www.stocorp.com](http://www.stocorp.com)

Sto products are intended for use by qualified professional contractors, not consumers, as a component of a larger construction assembly as specified by a qualified design professional, general contractor or builder. They should be installed in accordance with those specifications and Sto's instructions. Sto Corp. disclaims all, and assumes no, liability for on-site inspections, for its products applied improperly, or by unqualified persons or entities, or as part of an improperly designed or constructed building, for the nonperformance of adjacent building components or assemblies, or for other construction activities beyond Sto's control. Improper use of Sto products or use as part of an improperly designed or constructed larger assembly or building may result in serious damage to Sto products, and to the structure of the building or its components.

STO CORP. DISCLAIMS ALL WARRANTIES EXPRESSED OR IMPLIED EXCEPT FOR EXPLICIT LIMITED WRITTEN WARRANTIES ISSUED TO AND ACCEPTED BY BUILDING OWNERS IN ACCORDANCE WITH STO'S WARRANTY PROGRAMS WHICH ARE SUBJECT TO CHANGE FROM TIME TO TIME. For the fullest, most current information on proper application, clean-up, mixing and other specifications and warranties, cautions and disclaimers, please refer to the Sto Corp. website. [www.stocorp.com](http://www.stocorp.com)



# StoTherm® ci Flanged Window-Head

Detail No.: 52s.24B-1  
Date: June 2022

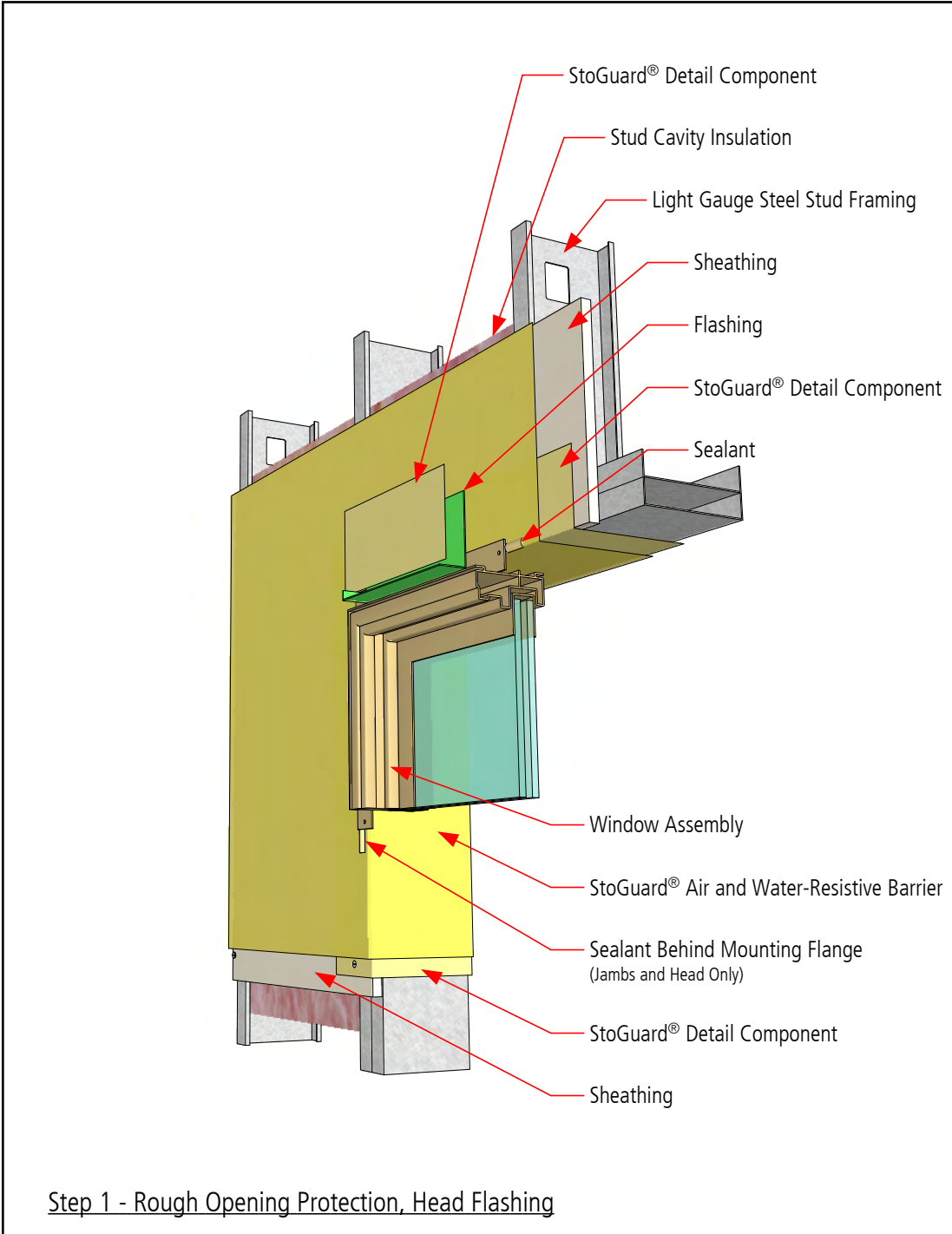

- Notes:
1. Refer to StoGuard Product Use Chart (Table 1.1) for StoGuard detail components; joint treatment, rough opening protection, backing for masonry anchors, or transitions to dissimilar materials, joints and seams in construction.
  2. Refer to General Notes for specific information and design guidance on wall assembly components.
  3. Components not identified as Sto are furnished by other manufacturers and are not necessarily installed by trades who install the Sto products. Refer to project specific contract documents.

**ATTENTION**

Property of Sto Corp. All Rights Reserved

Sto products are intended for use by qualified professional contractors, not consumers, as a component of a larger construction assembly as specified by a qualified design professional, general contractor or builder. They should be installed in accordance with those specifications and Sto's instructions. Sto Corp. disclaims all, and assumes no, liability for on-site inspections, for its products applied improperly, or by unqualified persons or entities, or as part of an improperly designed or constructed building, for the nonperformance of adjacent building components or assemblies, or for other construction activities beyond Sto's control. Improper use of Sto products or use as part of an improperly designed or constructed larger assembly or building may result in serious damage to Sto products, and to the structure of the building or its components.

STO CORP. DISCLAIMS ALL WARRANTIES EXPRESSED OR IMPLIED EXCEPT FOR EXPLICIT LIMITED WRITTEN WARRANTIES ISSUED TO AND ACCEPTED BY BUILDING OWNERS IN ACCORDANCE WITH STO'S WARRANTY PROGRAMS WHICH ARE SUBJECT TO CHANGE FROM TIME TO TIME. For the fullest, most current information on proper application, clean-up, mixing and other specifications and warranties, cautions and disclaimers, please refer to the Sto Corp. website. [www.stocorp.com](http://www.stocorp.com)

[www.stocorp.com](http://www.stocorp.com)





# StoTherm® ci Flanged Window-Head

Detail No.: 52s.24B-2  
Date: June 2022

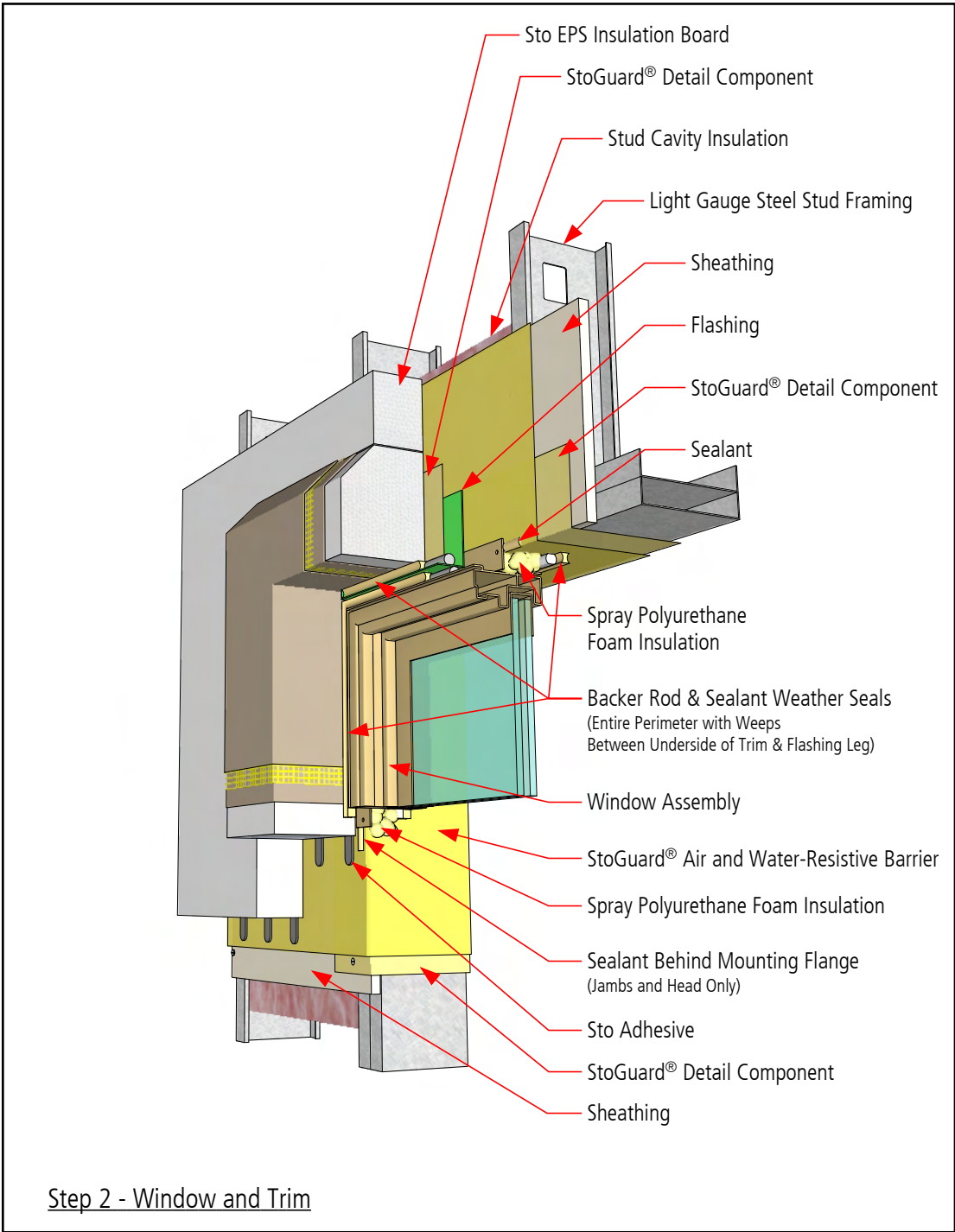

- Notes:
1. Refer to StoGuard Product Use Chart (Table 1.1) for StoGuard detail components; joint treatment, rough opening protection, backing for masonry anchors, or transitions to dissimilar materials, joints and seams in construction.
  2. Refer to General Notes for specific information and design guidance on wall assembly components.
  3. Components not identified as Sto are furnished by other manufacturers and are not necessarily installed by trades who install the Sto products. Refer to project specific contract documents.

**ATTENTION**

Property of Sto Corp. All Rights Reserved

[www.stocorp.com](http://www.stocorp.com)

Sto products are intended for use by qualified professional contractors, not consumers, as a component of a larger construction assembly as specified by a qualified design professional, general contractor or builder. They should be installed in accordance with those specifications and Sto's instructions. Sto Corp. disclaims all, and assumes no, liability for on-site inspections, for its products applied improperly, or by unqualified persons or entities, or as part of an improperly designed or constructed building, for the nonperformance of adjacent building components or assemblies, or for other construction activities beyond Sto's control. Improper use of Sto products or use as part of an improperly designed or constructed larger assembly or building may result in serious damage to Sto products, and to the structure of the building or its components.

STO CORP. DISCLAIMS ALL WARRANTIES EXPRESSED OR IMPLIED EXCEPT FOR EXPLICIT LIMITED WRITTEN WARRANTIES ISSUED TO AND ACCEPTED BY BUILDING OWNERS IN ACCORDANCE WITH STO'S WARRANTY PROGRAMS WHICH ARE SUBJECT TO CHANGE FROM TIME TO TIME. For the fullest, most current information on proper application, clean-up, mixing and other specifications and warranties, cautions and disclaimers, please refer to the Sto Corp. website. [www.stocorp.com](http://www.stocorp.com)



# StoTherm® ci Flanged Window-Head

Detail No.: 52s.24B-3  
Date: June 2022

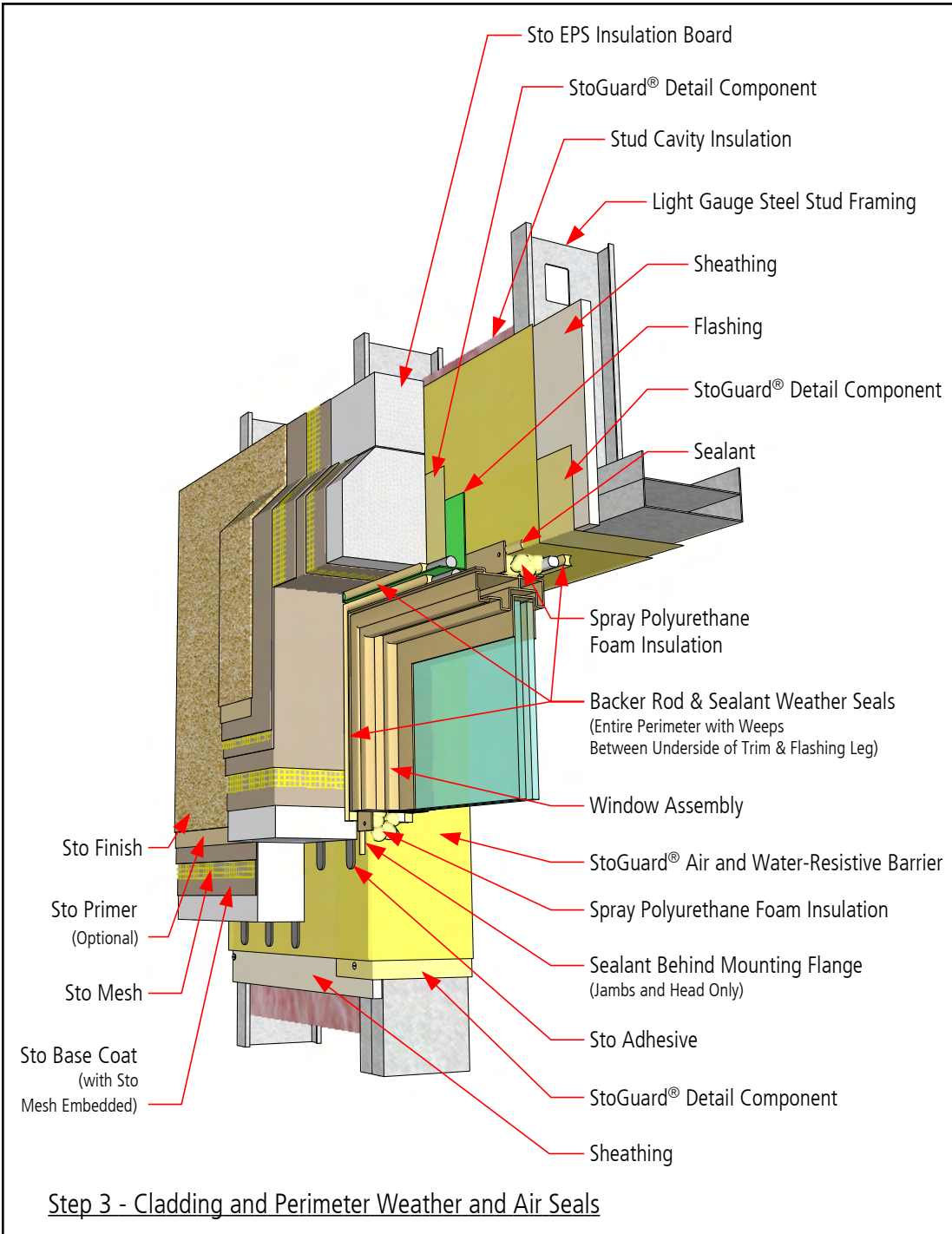

Notes:

1. Refer to StoGuard Product Use Chart (Table 1.1) for StoGuard detail components; joint treatment, rough opening protection, backing for masonry anchors, or transitions to dissimilar materials, joints and seams in construction.
2. Refer to General Notes for specific information and design guidance on wall assembly components.
3. Components not identified as Sto are furnished by other manufacturers and are not necessarily installed by trades who install the Sto products. Refer to project specific contract documents.

**ATTENTION**

Property of Sto Corp. All Rights Reserved

Sto products are intended for use by qualified professional contractors, not consumers, as a component of a larger construction assembly as specified by a qualified design professional, general contractor or builder. They should be installed in accordance with those specifications and Sto's instructions. Sto Corp. disclaims all, and assumes no, liability for on-site inspections, for its products applied improperly, or by unqualified persons or entities, or as part of an improperly designed or constructed building, for the nonperformance of adjacent building components or assemblies, or for other construction activities beyond Sto's control. Improper use of Sto products or use as part of an improperly designed or constructed larger assembly or building may result in serious damage to Sto products, and to the structure of the building or its components.

STO CORP. DISCLAIMS ALL WARRANTIES EXPRESSED OR IMPLIED EXCEPT FOR EXPLICIT LIMITED WRITTEN WARRANTIES ISSUED TO AND ACCEPTED BY BUILDING OWNERS IN ACCORDANCE WITH STO'S WARRANTY PROGRAMS WHICH ARE SUBJECT TO CHANGE FROM TIME TO TIME. For the fullest, most current information on proper application, clean-up, mixing and other specifications and warranties, cautions and disclaimers, please refer to the Sto Corp. website. [www.stocorp.com](http://www.stocorp.com)

[www.stocorp.com](http://www.stocorp.com)



# StoTherm® ci

## Soffit: Insulated and Unvented

Detail No.: 52s.30  
Date: June 2022

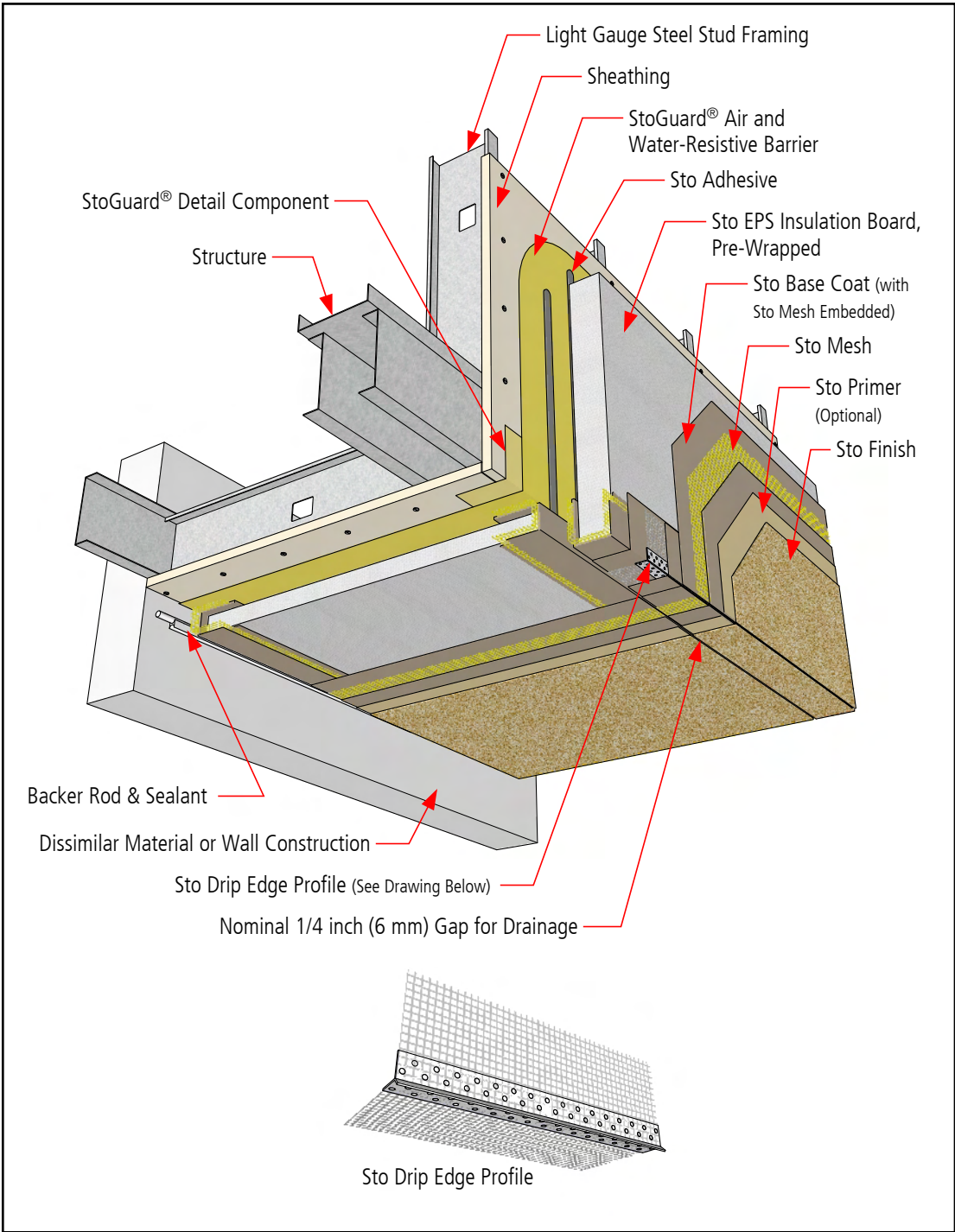

Notes:

1. Refer to StoGuard Product Use Chart (Table 1.1) for StoGuard detail components; joint treatment, rough opening protection, backing for masonry anchors, or transitions to dissimilar materials, joints and seams in construction.
2. Refer to General Notes for specific information and design guidance on wall assembly components.
3. Components not identified as Sto are furnished by other manufacturers and are not necessarily installed by trades who install the Sto products. Refer to project specific contract documents.

**ATTENTION**

Property of Sto Corp. All Rights Reserved

[www.stocorp.com](http://www.stocorp.com)

Sto products are intended for use by qualified professional contractors, not consumers, as a component of a larger construction assembly as specified by a qualified design professional, general contractor or builder. They should be installed in accordance with those specifications and Sto's instructions. Sto Corp. disclaims all, and assumes no, liability for on-site inspections, for its products applied improperly, or by unqualified persons or entities, or as part of an improperly designed or constructed building, for the nonperformance of adjacent building components or assemblies, or for other construction activities beyond Sto's control. Improper use of Sto products or use as part of an improperly designed or constructed larger assembly or building may result in serious damage to Sto products, and to the structure of the building or its components.

STO CORP. DISCLAIMS ALL WARRANTIES EXPRESSED OR IMPLIED EXCEPT FOR EXPLICIT LIMITED WRITTEN WARRANTIES ISSUED TO AND ACCEPTED BY BUILDING OWNERS IN ACCORDANCE WITH STO'S WARRANTY PROGRAMS WHICH ARE SUBJECT TO CHANGE FROM TIME TO TIME. For the fullest, most current information on proper application, clean-up, mixing and other specifications and warranties, cautions and disclaimers, please refer to the Sto Corp. website. [www.stocorp.com](http://www.stocorp.com)



# StoTherm® ci

## Soffit: Uninsulated and Vented

Detail No.: 52s.31  
Date: June 2022

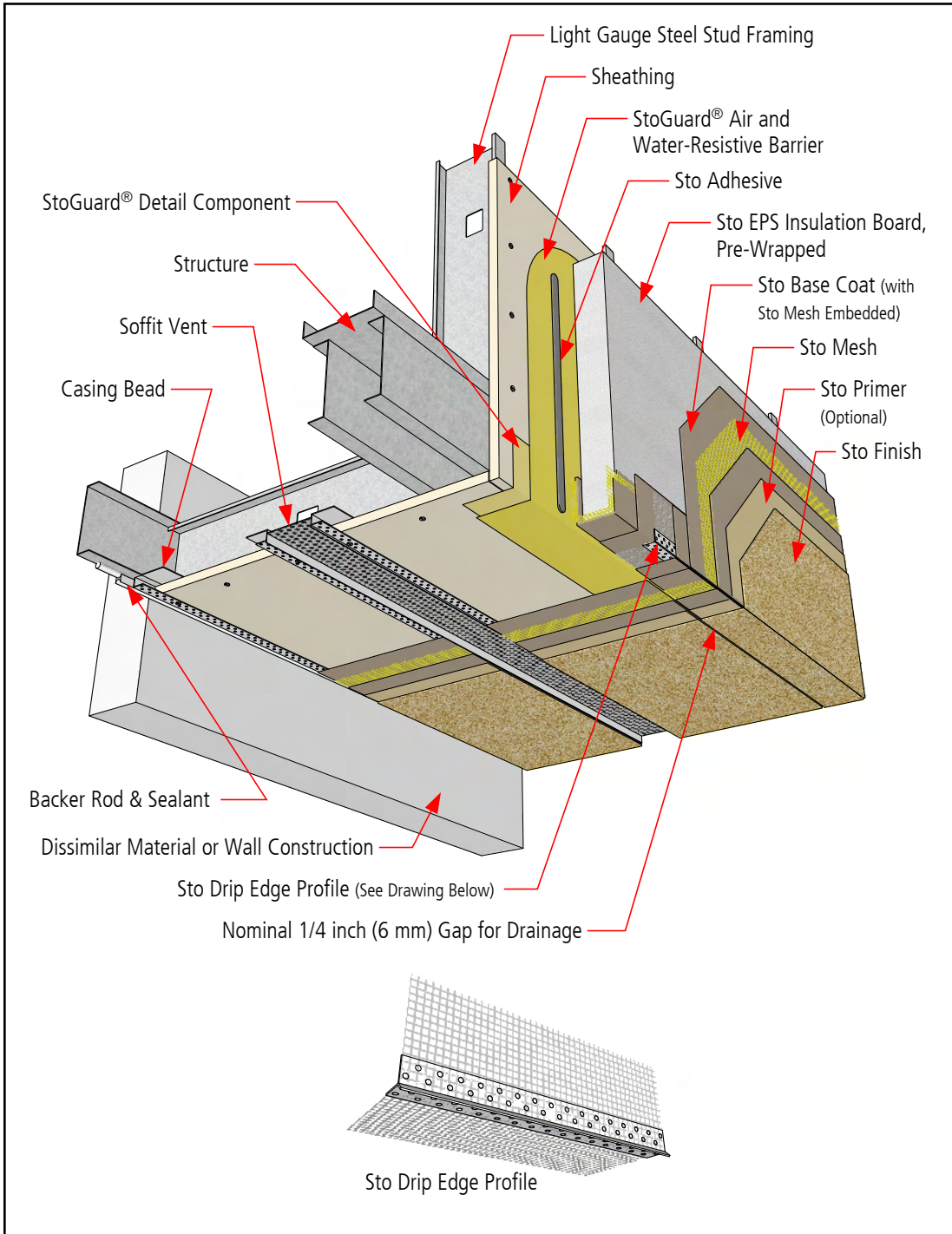

### Notes:

1. Refer to StoGuard Product Use Chart (Table 1.1) for StoGuard detail components; joint treatment, rough opening protection, backing for masonry anchors, or transitions to dissimilar materials, joints and seams in construction.
2. Refer to General Notes for specific information and design guidance on wall assembly components.
3. Components not identified as Sto are furnished by other manufacturers and are not necessarily installed by trades who install the Sto products. Refer to project specific contract documents.

### ATTENTION

Property of Sto Corp. All Rights Reserved

[www.stocorp.com](http://www.stocorp.com)

Sto products are intended for use by qualified professional contractors, not consumers, as a component of a larger construction assembly as specified by a qualified design professional, general contractor or builder. They should be installed in accordance with those specifications and Sto's instructions. Sto Corp. disclaims all, and assumes no, liability for on-site inspections, for its products applied improperly, or by unqualified persons or entities, or as part of an improperly designed or constructed building, for the nonperformance of adjacent building components or assemblies, or for other construction activities beyond Sto's control. Improper use of Sto products or use as part of an improperly designed or constructed larger assembly or building may result in serious damage to Sto products, and to the structure of the building or its components.

STO CORP. DISCLAIMS ALL WARRANTIES EXPRESSED OR IMPLIED EXCEPT FOR EXPLICIT LIMITED WRITTEN WARRANTIES ISSUED TO AND ACCEPTED BY BUILDING OWNERS IN ACCORDANCE WITH STO'S WARRANTY PROGRAMS WHICH ARE SUBJECT TO CHANGE FROM TIME TO TIME. For the fullest, most current information on proper application, clean-up, mixing and other specifications and warranties, cautions and disclaimers, please refer to the Sto Corp. website. [www.stocorp.com](http://www.stocorp.com)



# StoTherm® ci Floor Line Without Deflection

Detail No.: 52s.40  
Date: June 2022

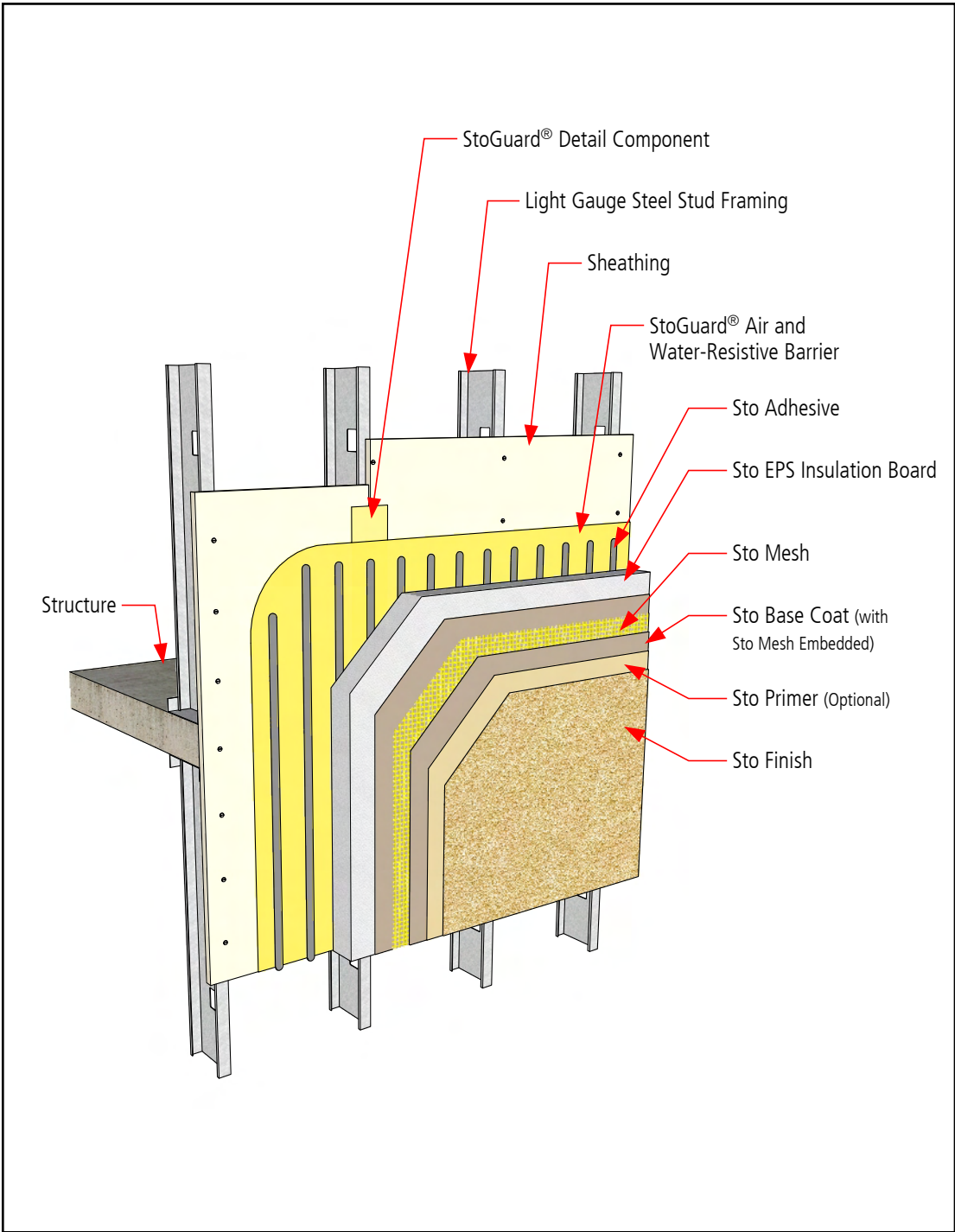

Notes:

1. Refer to StoGuard Product Use Chart (Table 1.1) for StoGuard detail components; joint treatment, rough opening protection, backing for masonry anchors, or transitions to dissimilar materials, joints and seams in construction.
2. Refer to General Notes for specific information and design guidance on wall assembly components.
3. Components not identified as Sto are furnished by other manufacturers and are not necessarily installed by trades who install the Sto products. Refer to project specific contract documents.

**ATTENTION**

Property of Sto Corp. All Rights Reserved

[www.stocorp.com](http://www.stocorp.com)

Sto products are intended for use by qualified professional contractors, not consumers, as a component of a larger construction assembly as specified by a qualified design professional, general contractor or builder. They should be installed in accordance with those specifications and Sto's instructions. Sto Corp. disclaims all, and assumes no, liability for on-site inspections, for its products applied improperly, or by unqualified persons or entities, or as part of an improperly designed or constructed building, for the nonperformance of adjacent building components or assemblies, or for other construction activities beyond Sto's control. Improper use of Sto products or use as part of an improperly designed or constructed larger assembly or building may result in serious damage to Sto products, and to the structure of the building or its components.

STO CORP. DISCLAIMS ALL WARRANTIES EXPRESSED OR IMPLIED EXCEPT FOR EXPLICIT LIMITED WRITTEN WARRANTIES ISSUED TO AND ACCEPTED BY BUILDING OWNERS IN ACCORDANCE WITH STO'S WARRANTY PROGRAMS WHICH ARE SUBJECT TO CHANGE FROM TIME TO TIME. For the fullest, most current information on proper application, clean-up, mixing and other specifications and warranties, cautions and disclaimers, please refer to the Sto Corp. website. [www.stocorp.com](http://www.stocorp.com)



# StoTherm® ci Floor Line With Deflection - Concealed Flashing and Drainage at Floor Line

Detail No.: 52s.41A  
Date: June 2022

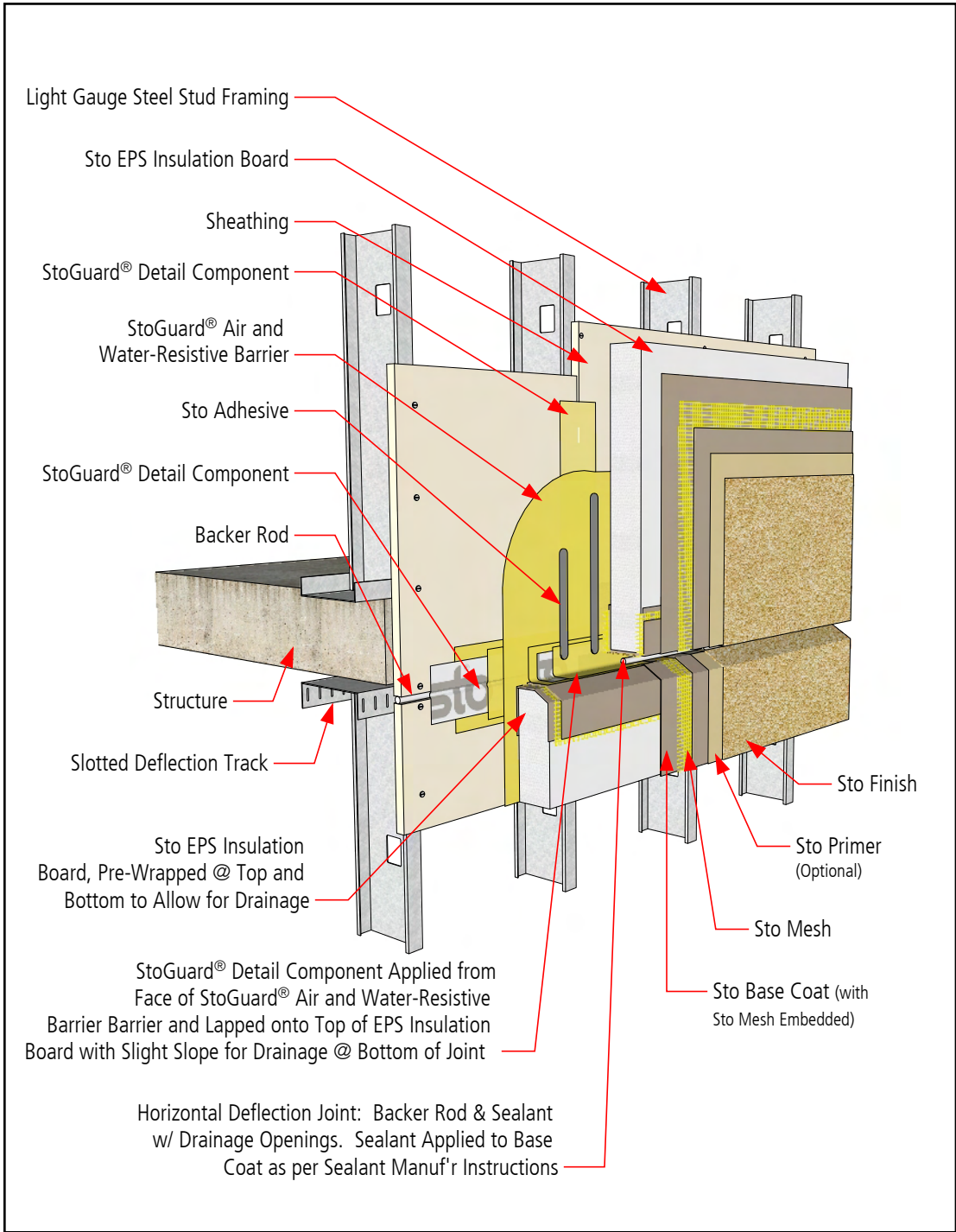

Notes:

1. Refer to StoGuard Product Use Chart (Table 1.1) for StoGuard detail components; joint treatment, rough opening protection, backing for masonry anchors, or transitions to dissimilar materials, joints and seams in construction.
2. Refer to General Notes for specific information and design guidance on wall assembly components.
3. Components not identified as Sto are furnished by other manufacturers and are not necessarily installed by trades who install the Sto products. Refer to project specific contract documents.

**ATTENTION**

Property of Sto Corp. All Rights Reserved

[www.stocorp.com](http://www.stocorp.com)

Sto products are intended for use by qualified professional contractors, not consumers, as a component of a larger construction assembly as specified by a qualified design professional, general contractor or builder. They should be installed in accordance with those specifications and Sto's instructions. Sto Corp. disclaims all, and assumes no, liability for on-site inspections, for its products applied improperly, or by unqualified persons or entities, or as part of an improperly designed or constructed building, for the nonperformance of adjacent building components or assemblies, or for other construction activities beyond Sto's control. Improper use of Sto products or use as part of an improperly designed or constructed larger assembly or building may result in serious damage to Sto products, and to the structure of the building or its components.

STO CORP. DISCLAIMS ALL WARRANTIES EXPRESSED OR IMPLIED EXCEPT FOR EXPLICIT LIMITED WRITTEN WARRANTIES ISSUED TO AND ACCEPTED BY BUILDING OWNERS IN ACCORDANCE WITH STO'S WARRANTY PROGRAMS WHICH ARE SUBJECT TO CHANGE FROM TIME TO TIME. For the fullest, most current information on proper application, clean-up, mixing and other specifications and warranties, cautions and disclaimers, please refer to the Sto Corp. website. [www.stocorp.com](http://www.stocorp.com)



# StoTherm® ci

## Floor Line With Deflection - No Drainage at Floor Line

Detail No.: 52s.41B  
Date: June 2022

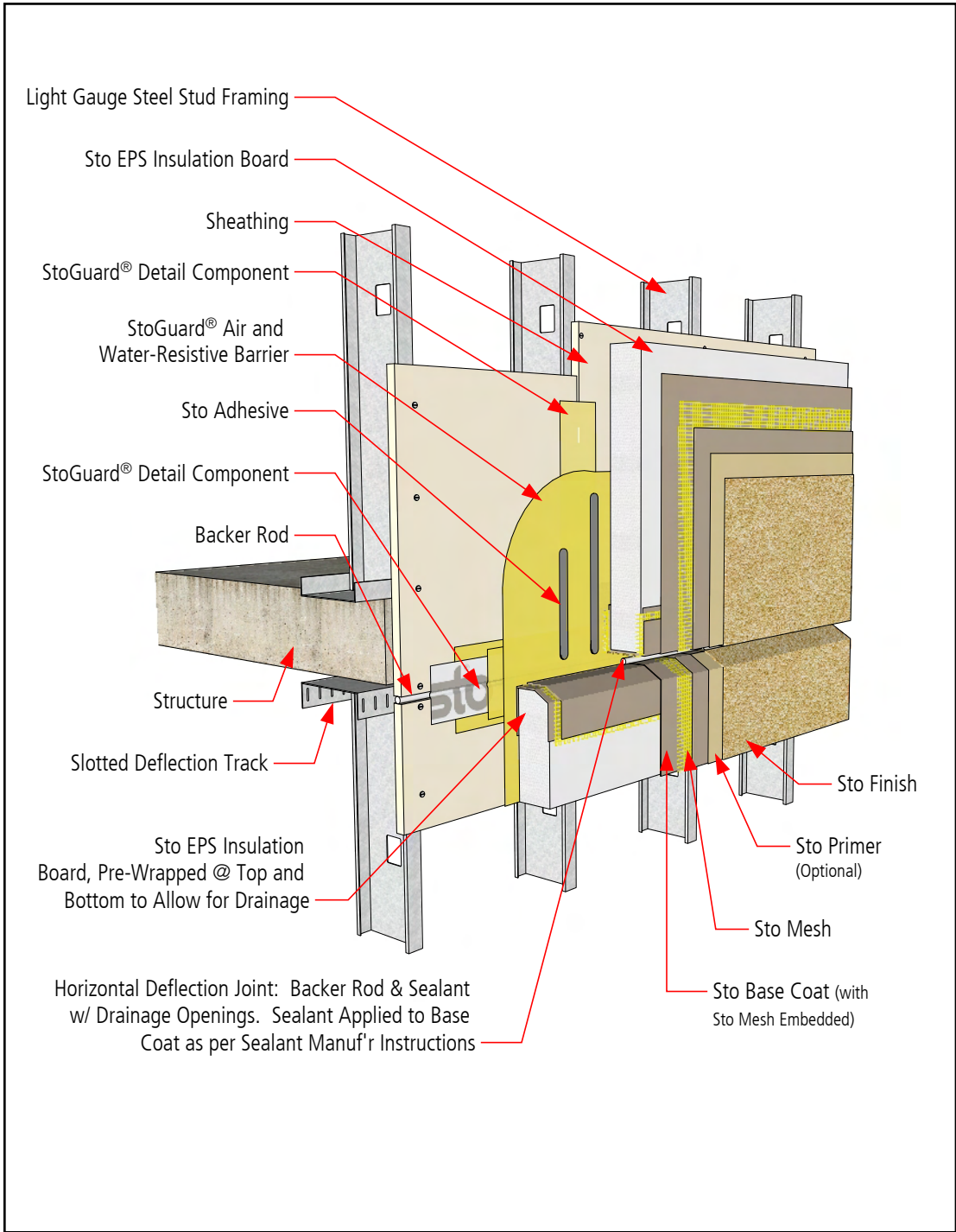

Notes:

1. Refer to StoGuard Product Use Chart (Table 1.1) for StoGuard detail components; joint treatment, rough opening protection, backing for masonry anchors, or transitions to dissimilar materials, joints and seams in construction.
2. Refer to General Notes for specific information and design guidance on wall assembly components.
3. Components not identified as Sto are furnished by other manufacturers and are not necessarily installed by trades who install the Sto products. Refer to project specific contract documents.

**ATTENTION**

Property of Sto Corp. All Rights Reserved

[www.stocorp.com](http://www.stocorp.com)

Sto products are intended for use by qualified professional contractors, not consumers, as a component of a larger construction assembly as specified by a qualified design professional, general contractor or builder. They should be installed in accordance with those specifications and Sto's instructions. Sto Corp. disclaims all, and assumes no, liability for on-site inspections, for its products applied improperly, or by unqualified persons or entities, or as part of an improperly designed or constructed building, for the nonperformance of adjacent building components or assemblies, or for other construction activities beyond Sto's control. Improper use of Sto products or use as part of an improperly designed or constructed larger assembly or building may result in serious damage to Sto products, and to the structure of the building or its components.

STO CORP. DISCLAIMS ALL WARRANTIES EXPRESSED OR IMPLIED EXCEPT FOR EXPLICIT LIMITED WRITTEN WARRANTIES ISSUED TO AND ACCEPTED BY BUILDING OWNERS IN ACCORDANCE WITH STO'S WARRANTY PROGRAMS WHICH ARE SUBJECT TO CHANGE FROM TIME TO TIME. For the fullest, most current information on proper application, clean-up, mixing and other specifications and warranties, cautions and disclaimers, please refer to the Sto Corp. website. [www.stocorp.com](http://www.stocorp.com)



# StoTherm® ci Balcony Floor/Wall

Detail No.: 52s.42A  
Date: June 2022

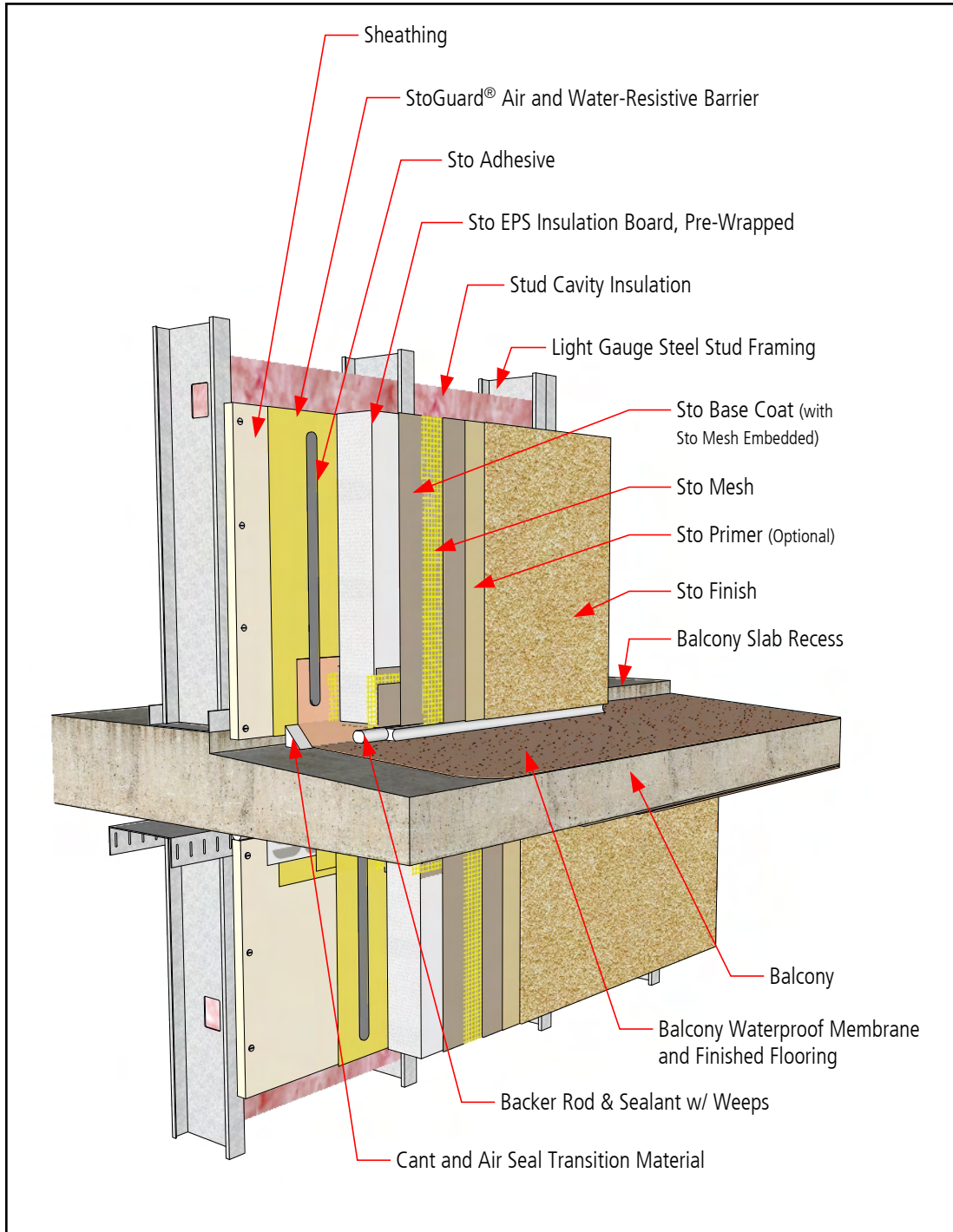

### Notes:

1. Refer to StoGuard Product Use Chart (Table 1.1) for StoGuard detail components; joint treatment, rough opening protection, backing for masonry anchors, or transitions to dissimilar materials, joints and seams in construction.
2. Refer to General Notes for specific information and design guidance on wall assembly components.
3. Components not identified as Sto are furnished by other manufacturers and are not necessarily installed by trades who install the Sto products. Refer to project specific contract documents.

### ATTENTION

Property of Sto Corp. All Rights Reserved

Sto products are intended for use by qualified professional contractors, not consumers, as a component of a larger construction assembly as specified by a qualified design professional, general contractor or builder. They should be installed in accordance with those specifications and Sto's instructions. Sto Corp. disclaims all, and assumes no, liability for on-site inspections, for its products applied improperly, or by unqualified persons or entities, or as part of an improperly designed or constructed building, for the nonperformance of adjacent building components or assemblies, or for other construction activities beyond Sto's control. Improper use of Sto products or use as part of an improperly designed or constructed larger assembly or building may result in serious damage to Sto products, and to the structure of the building or its components.

STO CORP. DISCLAIMS ALL WARRANTIES EXPRESSED OR IMPLIED EXCEPT FOR EXPLICIT LIMITED WRITTEN WARRANTIES ISSUED TO AND ACCEPTED BY BUILDING OWNERS IN ACCORDANCE WITH STO'S WARRANTY PROGRAMS WHICH ARE SUBJECT TO CHANGE FROM TIME TO TIME. For the fullest, most current information on proper application, clean-up, mixing and other specifications and warranties, cautions and disclaimers, please refer to the Sto Corp. website. [www.stocorp.com](http://www.stocorp.com)

[www.stocorp.com](http://www.stocorp.com)





# StoTherm® ci Balcony Ceiling/Wall

Detail No.: 52s.42B  
Date: June 2022

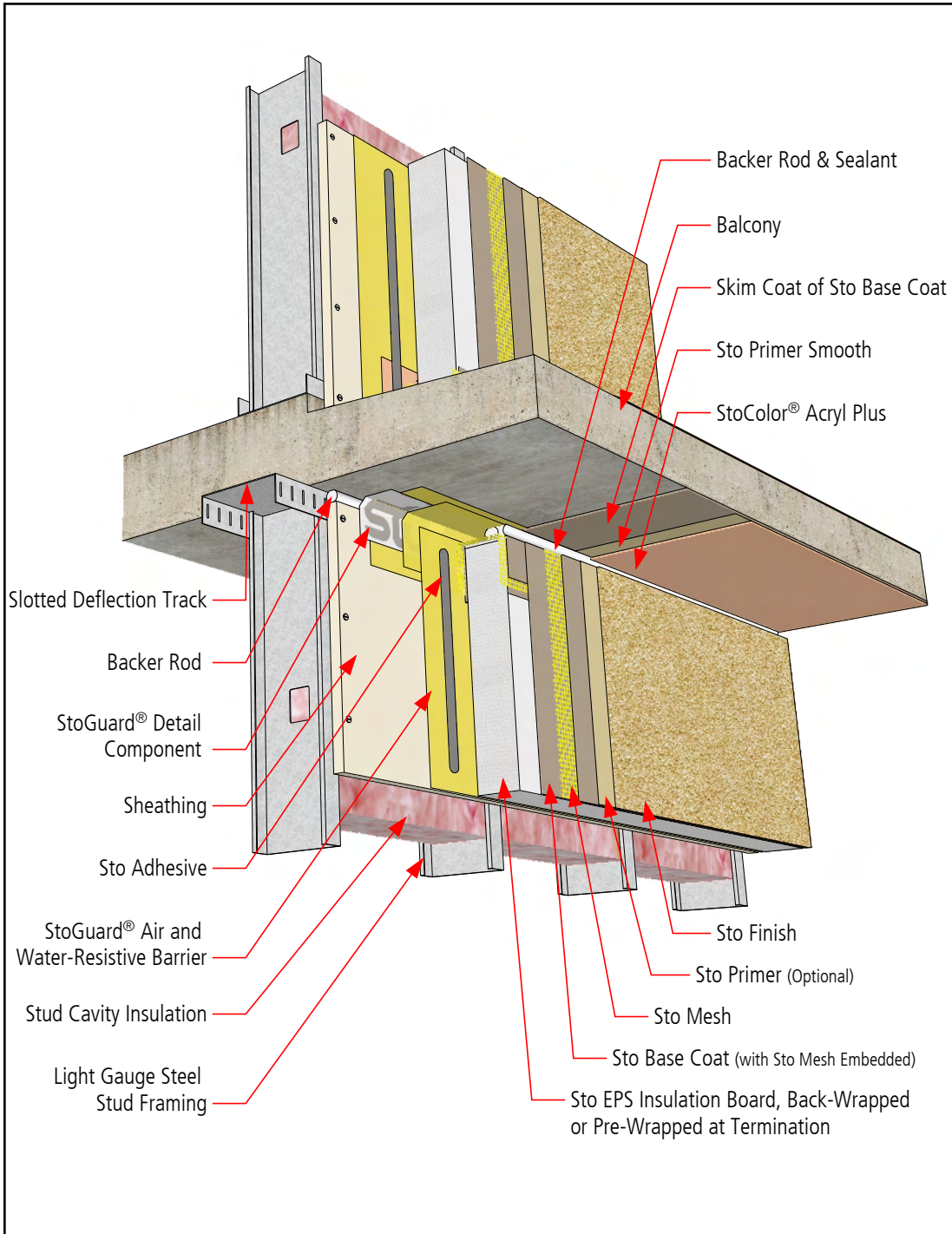

### Notes:

1. Refer to StoGuard Product Use Chart (Table 1.1) for StoGuard detail components; joint treatment, rough opening protection, backing for masonry anchors, or transitions to dissimilar materials, joints and seams in construction.
2. Refer to General Notes for specific information and design guidance on wall assembly components.
3. Components not identified as Sto are furnished by other manufacturers and are not necessarily installed by trades who install the Sto products. Refer to project specific contract documents.

### ATTENTION

Property of Sto Corp. All Rights Reserved

[www.stocorp.com](http://www.stocorp.com)

Sto products are intended for use by qualified professional contractors, not consumers, as a component of a larger construction assembly as specified by a qualified design professional, general contractor or builder. They should be installed in accordance with those specifications and Sto's instructions. Sto Corp. disclaims all, and assumes no, liability for on-site inspections, for its products applied improperly, or by unqualified persons or entities, or as part of an improperly designed or constructed building, for the nonperformance of adjacent building components or assemblies, or for other construction activities beyond Sto's control. Improper use of Sto products or use as part of an improperly designed or constructed larger assembly or building may result in serious damage to Sto products, and to the structure of the building or its components.

STO CORP. DISCLAIMS ALL WARRANTIES EXPRESSED OR IMPLIED EXCEPT FOR EXPLICIT LIMITED WRITTEN WARRANTIES ISSUED TO AND ACCEPTED BY BUILDING OWNERS IN ACCORDANCE WITH STO'S WARRANTY PROGRAMS WHICH ARE SUBJECT TO CHANGE FROM TIME TO TIME. For the fullest, most current information on proper application, clean-up, mixing and other specifications and warranties, cautions and disclaimers, please refer to the Sto Corp. website. [www.stocorp.com](http://www.stocorp.com)



# StoTherm® ci

## Horizontal Termination at Dissimilar Cladding

Detail No.: 52s.50  
Date: June 2022

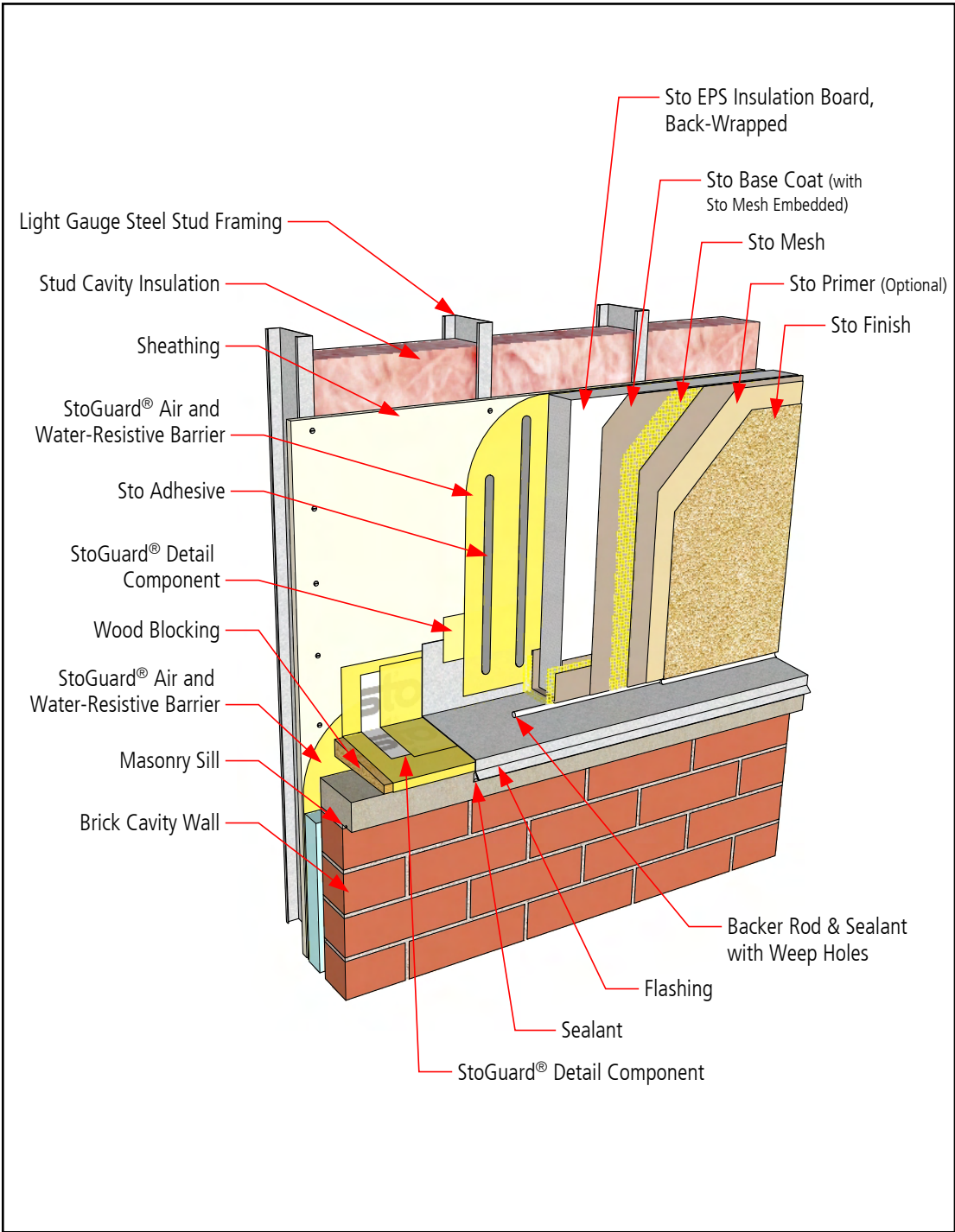

- Notes:
1. Refer to StoGuard Product Use Chart (Table 1.1) for StoGuard detail components; joint treatment, rough opening protection, backing for masonry anchors, or transitions to dissimilar materials, joints and seams in construction.
  2. Refer to General Notes for specific information and design guidance on wall assembly components.
  3. Components not identified as Sto are furnished by other manufacturers and are not necessarily installed by trades who install the Sto products. Refer to project specific contract documents.

**ATTENTION**

Property of Sto Corp. All Rights Reserved

[www.stocorp.com](http://www.stocorp.com)

Sto products are intended for use by qualified professional contractors, not consumers, as a component of a larger construction assembly as specified by a qualified design professional, general contractor or builder. They should be installed in accordance with those specifications and Sto's instructions. Sto Corp. disclaims all, and assumes no, liability for on-site inspections, for its products applied improperly, or by unqualified persons or entities, or as part of an improperly designed or constructed building, for the nonperformance of adjacent building components or assemblies, or for other construction activities beyond Sto's control. Improper use of Sto products or use as part of an improperly designed or constructed larger assembly or building may result in serious damage to Sto products, and to the structure of the building or its components.

STO CORP. DISCLAIMS ALL WARRANTIES EXPRESSED OR IMPLIED EXCEPT FOR EXPLICIT LIMITED WRITTEN WARRANTIES ISSUED TO AND ACCEPTED BY BUILDING OWNERS IN ACCORDANCE WITH STO'S WARRANTY PROGRAMS WHICH ARE SUBJECT TO CHANGE FROM TIME TO TIME. For the fullest, most current information on proper application, clean-up, mixing and other specifications and warranties, cautions and disclaimers, please refer to the Sto Corp. website. [www.stocorp.com](http://www.stocorp.com)



# StoTherm® ci Vertical Termination at Dissimilar Cladding

Detail No.: 52s.51A  
Date: June 2022

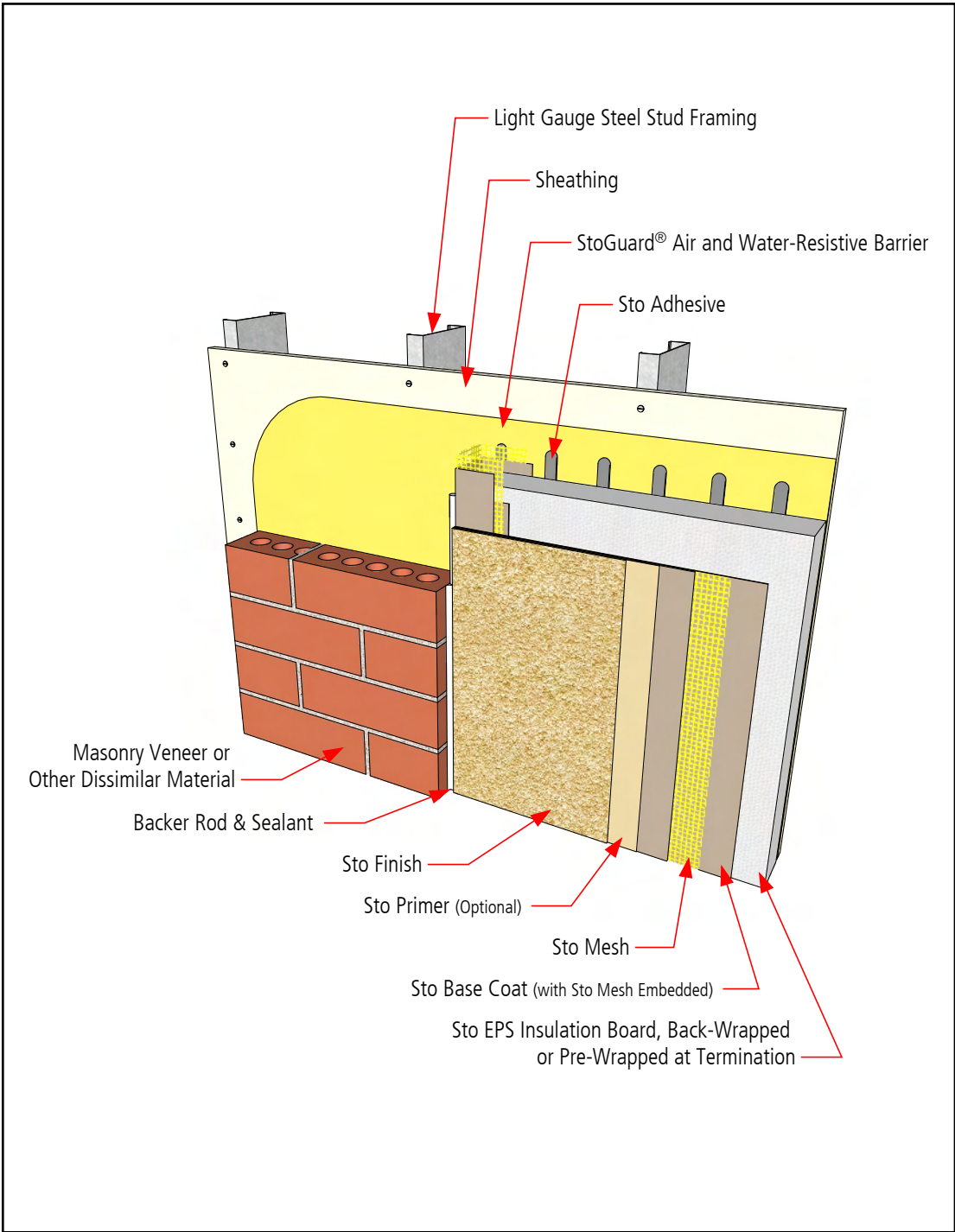

- Notes:
1. Refer to StoGuard Product Use Chart (Table 1.1) for StoGuard detail components; joint treatment, rough opening protection, backing for masonry anchors, or transitions to dissimilar materials, joints and seams in construction.
  2. Refer to General Notes for specific information and design guidance on wall assembly components.
  3. Components not identified as Sto are furnished by other manufacturers and are not necessarily installed by trades who install the Sto products. Refer to project specific contract documents.

**ATTENTION**

Property of Sto Corp. All Rights Reserved

[www.stocorp.com](http://www.stocorp.com)

Sto products are intended for use by qualified professional contractors, not consumers, as a component of a larger construction assembly as specified by a qualified design professional, general contractor or builder. They should be installed in accordance with those specifications and Sto's instructions. Sto Corp. disclaims all, and assumes no, liability for on-site inspections, for its products applied improperly, or by unqualified persons or entities, or as part of an improperly designed or constructed building, for the nonperformance of adjacent building components or assemblies, or for other construction activities beyond Sto's control. Improper use of Sto products or use as part of an improperly designed or constructed larger assembly or building may result in serious damage to Sto products, and to the structure of the building or its components.

STO CORP. DISCLAIMS ALL WARRANTIES EXPRESSED OR IMPLIED EXCEPT FOR EXPLICIT LIMITED WRITTEN WARRANTIES ISSUED TO AND ACCEPTED BY BUILDING OWNERS IN ACCORDANCE WITH STO'S WARRANTY PROGRAMS WHICH ARE SUBJECT TO CHANGE FROM TIME TO TIME. For the fullest, most current information on proper application, clean-up, mixing and other specifications and warranties, cautions and disclaimers, please refer to the Sto Corp. website. [www.stocorp.com](http://www.stocorp.com)



# StoTherm® ci

## Vertical Termination at Dissimilar Backup Wall Construction

Detail No.: 52s.51B  
Date: June 2022

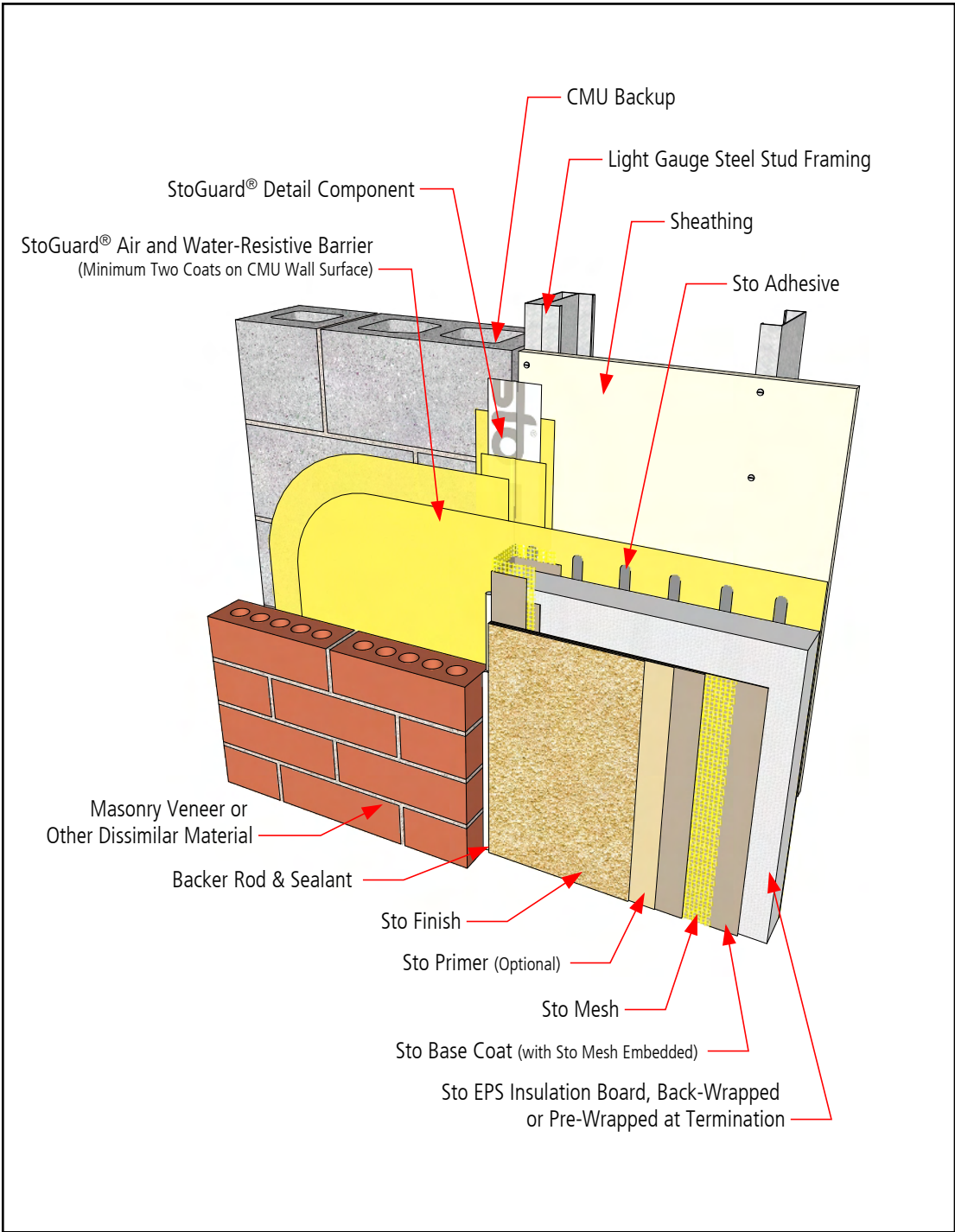

- Notes:
1. Refer to StoGuard Product Use Chart (Table 1.1) for StoGuard detail components; joint treatment, rough opening protection, backing for masonry anchors, or transitions to dissimilar materials, joints and seams in construction.
  2. Refer to General Notes for specific information and design guidance on wall assembly components.
  3. Components not identified as Sto are furnished by other manufacturers and are not necessarily installed by trades who install the Sto products. Refer to project specific contract documents.

**ATTENTION**

Property of Sto Corp. All Rights Reserved

[www.stocorp.com](http://www.stocorp.com)

Sto products are intended for use by qualified professional contractors, not consumers, as a component of a larger construction assembly as specified by a qualified design professional, general contractor or builder. They should be installed in accordance with those specifications and Sto's instructions. Sto Corp. disclaims all, and assumes no, liability for on-site inspections, for its products applied improperly, or by unqualified persons or entities, or as part of an improperly designed or constructed building, for the nonperformance of adjacent building components or assemblies, or for other construction activities beyond Sto's control. Improper use of Sto products or use as part of an improperly designed or constructed larger assembly or building may result in serious damage to Sto products, and to the structure of the building or its components.

STO CORP. DISCLAIMS ALL WARRANTIES EXPRESSED OR IMPLIED EXCEPT FOR EXPLICIT LIMITED WRITTEN WARRANTIES ISSUED TO AND ACCEPTED BY BUILDING OWNERS IN ACCORDANCE WITH STO'S WARRANTY PROGRAMS WHICH ARE SUBJECT TO CHANGE FROM TIME TO TIME. For the fullest, most current information on proper application, clean-up, mixing and other specifications and warranties, cautions and disclaimers, please refer to the Sto Corp. website. [www.stocorp.com](http://www.stocorp.com)



# StoTherm® ci Vertical Expansion Joint in Back-Up Wall

Detail No.: 52s.52A  
Date: June 2022

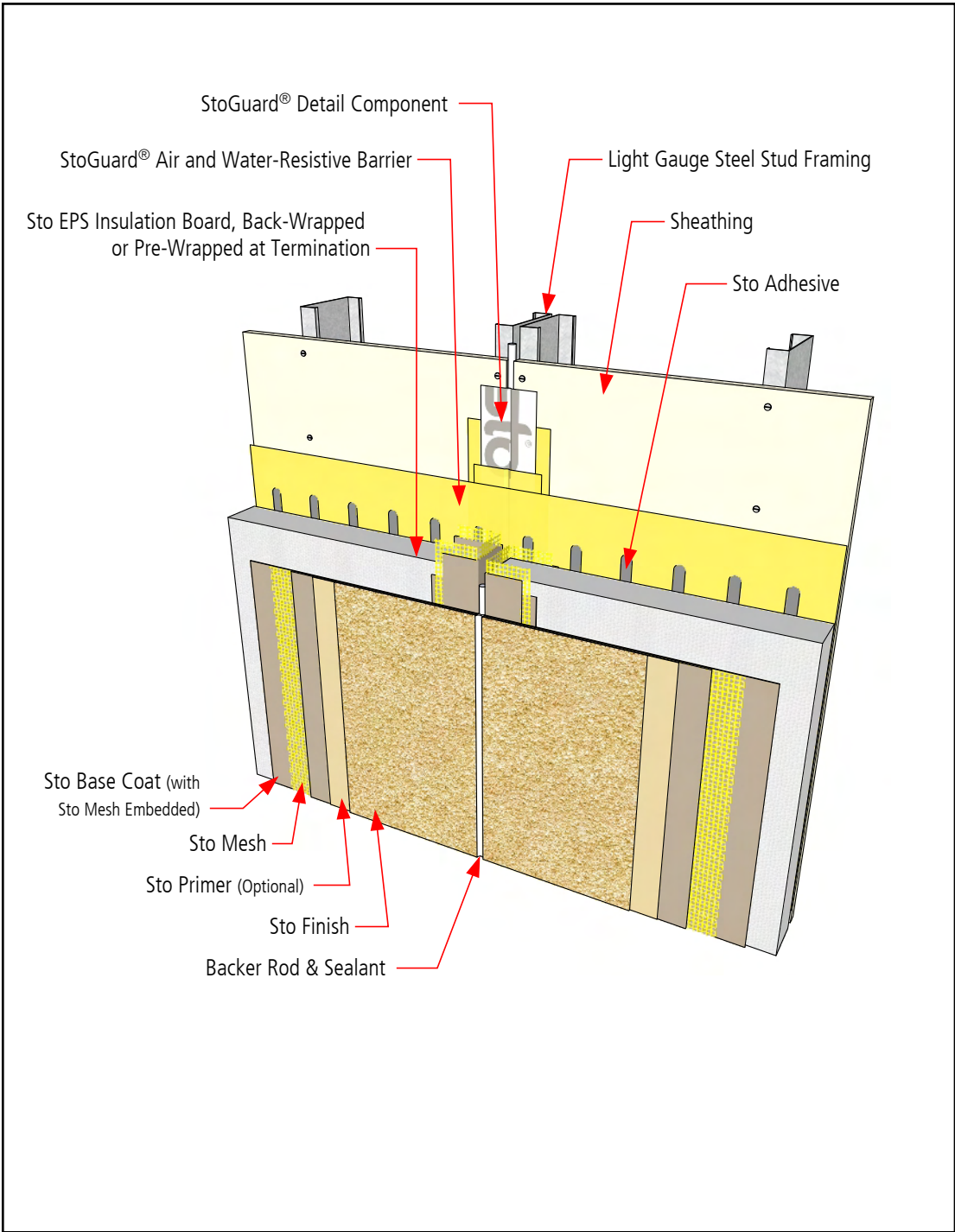

**Notes:**

1. Refer to StoGuard Product Use Chart (Table 1.1) for StoGuard detail components; joint treatment, rough opening protection, backing for masonry anchors, or transitions to dissimilar materials, joints and seams in construction.
2. Refer to General Notes for specific information and design guidance on wall assembly components.
3. Components not identified as Sto are furnished by other manufacturers and are not necessarily installed by trades who install the Sto products. Refer to project specific contract documents.

**ATTENTION**

Property of Sto Corp. All Rights Reserved

[www.stocorp.com](http://www.stocorp.com)

Sto products are intended for use by qualified professional contractors, not consumers, as a component of a larger construction assembly as specified by a qualified design professional, general contractor or builder. They should be installed in accordance with those specifications and Sto's instructions. Sto Corp. disclaims all, and assumes no, liability for on-site inspections, for its products applied improperly, or by unqualified persons or entities, or as part of an improperly designed or constructed building, for the nonperformance of adjacent building components or assemblies, or for other construction activities beyond Sto's control. Improper use of Sto products or use as part of an improperly designed or constructed larger assembly or building may result in serious damage to Sto products, and to the structure of the building or its components.

STO CORP. DISCLAIMS ALL WARRANTIES EXPRESSED OR IMPLIED EXCEPT FOR EXPLICIT LIMITED WRITTEN WARRANTIES ISSUED TO AND ACCEPTED BY BUILDING OWNERS IN ACCORDANCE WITH STO'S WARRANTY PROGRAMS WHICH ARE SUBJECT TO CHANGE FROM TIME TO TIME. For the fullest, most current information on proper application, clean-up, mixing and other specifications and warranties, cautions and disclaimers, please refer to the Sto Corp. website. [www.stocorp.com](http://www.stocorp.com)



# StoTherm® ci

## Vertical Expansion Joint in Back-Up Wall, StoTherm ci and Dissimilar Cladding

Detail No.: 52s.52B  
Date: June 2022

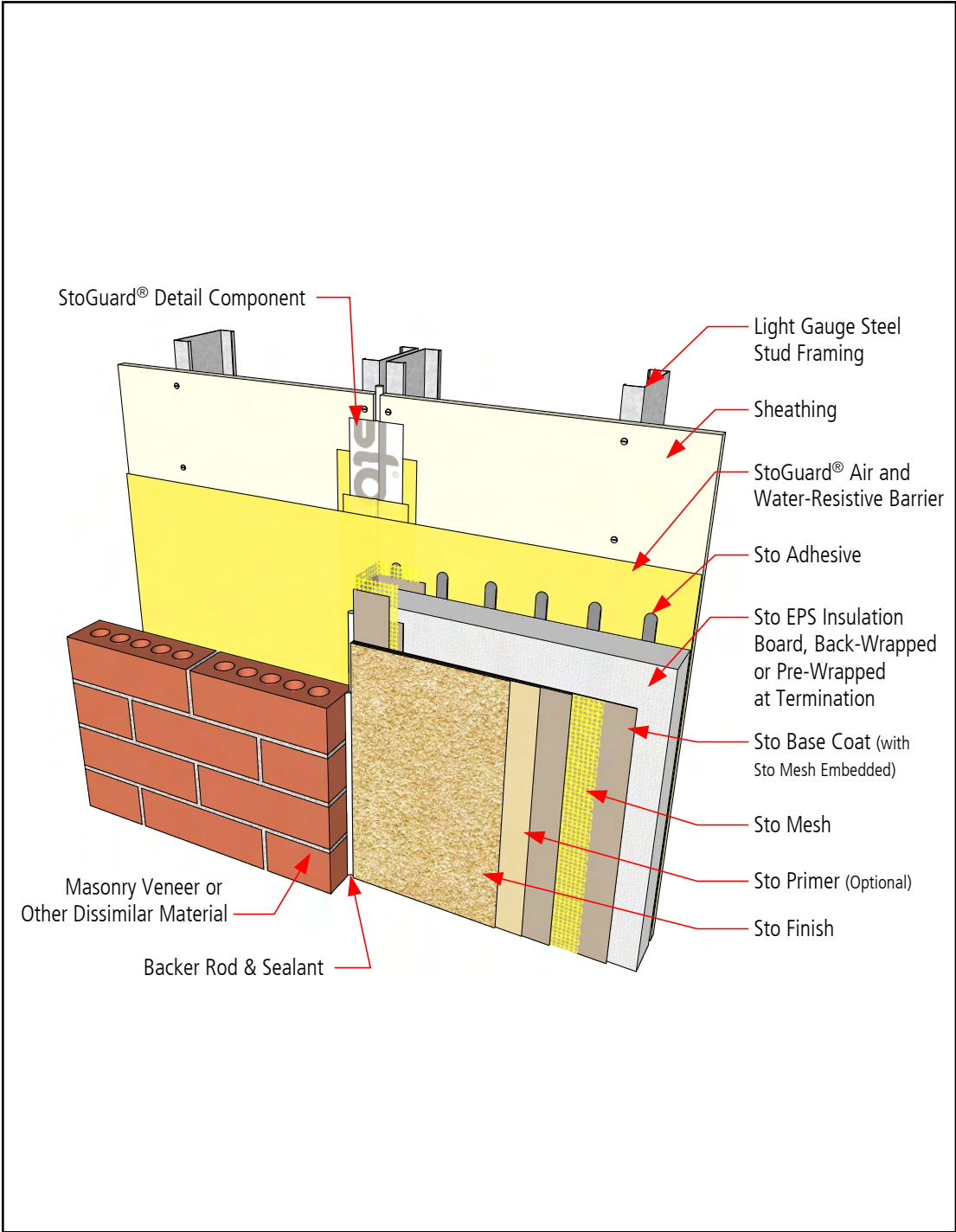

### Notes:

1. Refer to StoGuard Product Use Chart (Table 1.1) for StoGuard detail components; joint treatment, rough opening protection, backing for masonry anchors, or transitions to dissimilar materials, joints and seams in construction.
2. Refer to General Notes for specific information and design guidance on wall assembly components.
3. Components not identified as Sto are furnished by other manufacturers and are not necessarily installed by trades who install the Sto products. Refer to project specific contract documents.

### ATTENTION

Property of Sto Corp. All Rights Reserved

[www.stocorp.com](http://www.stocorp.com)

Sto products are intended for use by qualified professional contractors, not consumers, as a component of a larger construction assembly as specified by a qualified design professional, general contractor or builder. They should be installed in accordance with those specifications and Sto's instructions. Sto Corp. disclaims all, and assumes no, liability for on-site inspections, for its products applied improperly, or by unqualified persons or entities, or as part of an improperly designed or constructed building, for the nonperformance of adjacent building components or assemblies, or for other construction activities beyond Sto's control. Improper use of Sto products or use as part of an improperly designed or constructed larger assembly or building may result in serious damage to Sto products, and to the structure of the building or its components.

STO CORP. DISCLAIMS ALL WARRANTIES EXPRESSED OR IMPLIED EXCEPT FOR EXPLICIT LIMITED WRITTEN WARRANTIES ISSUED TO AND ACCEPTED BY BUILDING OWNERS IN ACCORDANCE WITH STO'S WARRANTY PROGRAMS WHICH ARE SUBJECT TO CHANGE FROM TIME TO TIME. For the fullest, most current information on proper application, clean-up, mixing and other specifications and warranties, cautions and disclaimers, please refer to the Sto Corp. website. [www.stocorp.com](http://www.stocorp.com)



# StoTherm® ci Inside Corner with Dissimilar Backup Wall

Detail No.: 52s.53  
Date: June 2022

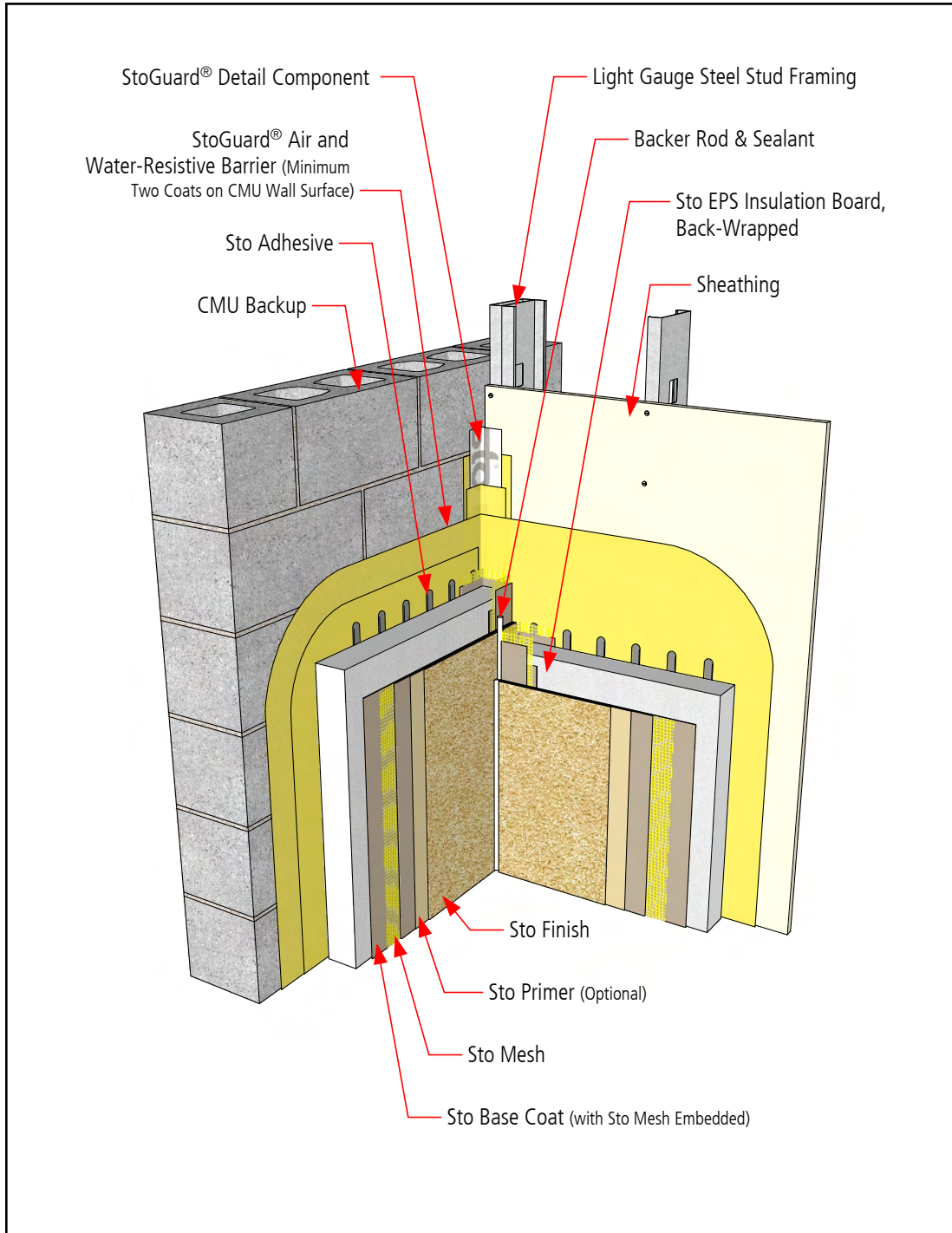

Notes:

1. Refer to StoGuard Product Use Chart (Table 1.1) for StoGuard detail components; joint treatment, rough opening protection, backing for masonry anchors, or transitions to dissimilar materials, joints and seams in construction.
2. Refer to General Notes for specific information and design guidance on wall assembly components.
3. Components not identified as Sto are furnished by other manufacturers and are not necessarily installed by trades who install the Sto products. Refer to project specific contract documents.

**ATTENTION**

Property of Sto Corp. All Rights Reserved

[www.stocorp.com](http://www.stocorp.com)

Sto products are intended for use by qualified professional contractors, not consumers, as a component of a larger construction assembly as specified by a qualified design professional, general contractor or builder. They should be installed in accordance with those specifications and Sto's instructions. Sto Corp. disclaims all, and assumes no, liability for on-site inspections, for its products applied improperly, or by unqualified persons or entities, or as part of an improperly designed or constructed building, for the nonperformance of adjacent building components or assemblies, or for other construction activities beyond Sto's control. Improper use of Sto products or use as part of an improperly designed or constructed larger assembly or building may result in serious damage to Sto products, and to the structure of the building or its components.

STO CORP. DISCLAIMS ALL WARRANTIES EXPRESSED OR IMPLIED EXCEPT FOR EXPLICIT LIMITED WRITTEN WARRANTIES ISSUED TO AND ACCEPTED BY BUILDING OWNERS IN ACCORDANCE WITH STO'S WARRANTY PROGRAMS WHICH ARE SUBJECT TO CHANGE FROM TIME TO TIME. For the fullest, most current information on proper application, clean-up, mixing and other specifications and warranties, cautions and disclaimers, please refer to the Sto Corp. website. [www.stocorp.com](http://www.stocorp.com)



**StoTherm® ci**  
**Inside and Outside Corner with Common Substrate**  
**and StoMesh Corner Bead Reinforcement**

**Detail No.: 52s.54A**  
**Date: June 2022**

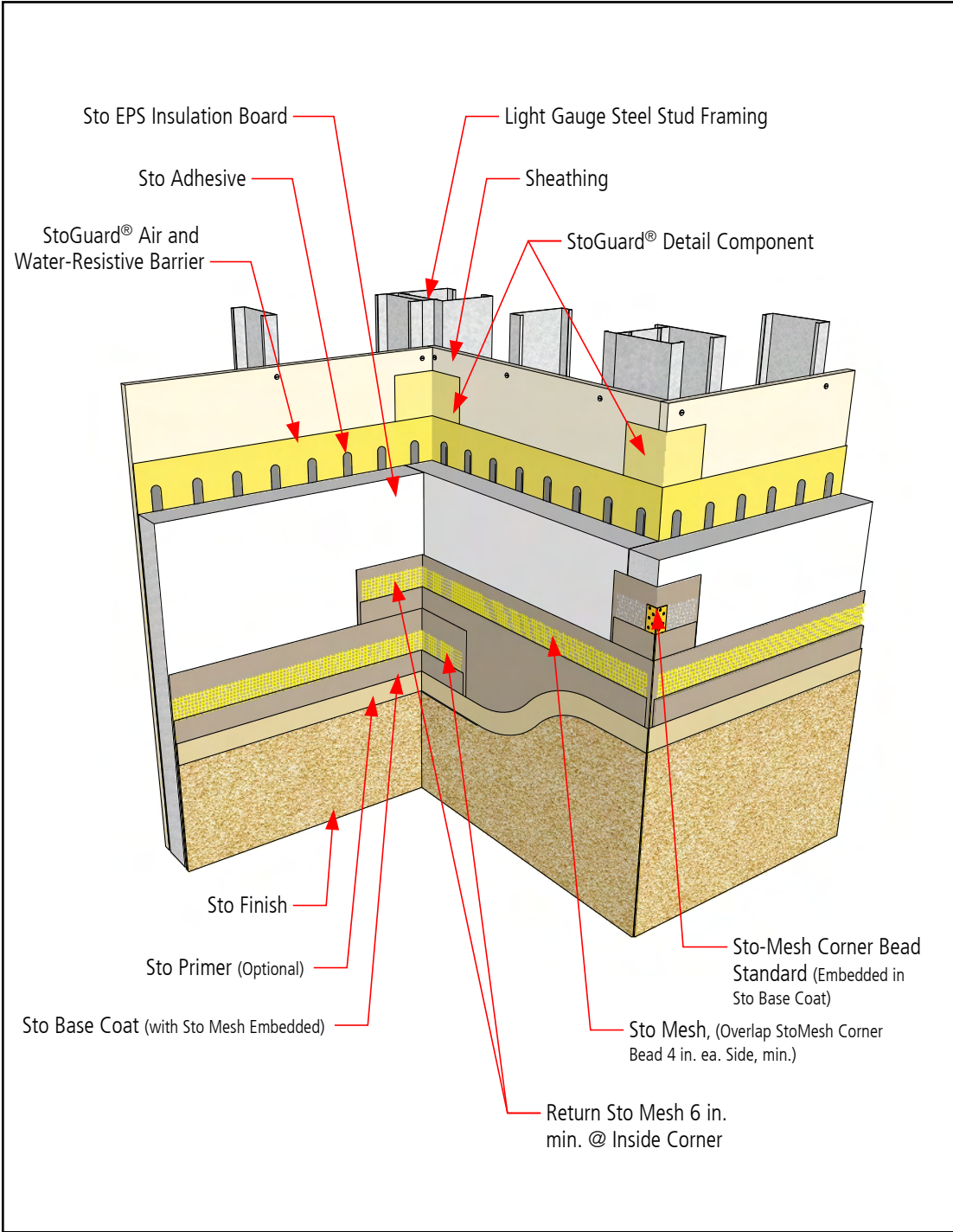

- Notes:
1. Refer to StoGuard Product Use Chart (Table 1.1) for StoGuard detail components; joint treatment, rough opening protection, backing for masonry anchors, or transitions to dissimilar materials, joints and seams in construction.
  2. Refer to General Notes for specific information and design guidance on wall assembly components.
  3. Components not identified as Sto are furnished by other manufacturers and are not necessarily installed by trades who install the Sto products. Refer to project specific contract documents.

**ATTENTION**

Property of Sto Corp. All Rights Reserved

[www.stocorp.com](http://www.stocorp.com)

Sto products are intended for use by qualified professional contractors, not consumers, as a component of a larger construction assembly as specified by a qualified design professional, general contractor or builder. They should be installed in accordance with those specifications and Sto's instructions. Sto Corp. disclaims all, and assumes no, liability for on-site inspections, for its products applied improperly, or by unqualified persons or entities, or as part of an improperly designed or constructed building, for the nonperformance of adjacent building components or assemblies, or for other construction activities beyond Sto's control. Improper use of Sto products or use as part of an improperly designed or constructed larger assembly or building may result in serious damage to Sto products, and to the structure of the building or its components.

STO CORP. DISCLAIMS ALL WARRANTIES EXPRESSED OR IMPLIED EXCEPT FOR EXPLICIT LIMITED WRITTEN WARRANTIES ISSUED TO AND ACCEPTED BY BUILDING OWNERS IN ACCORDANCE WITH STO'S WARRANTY PROGRAMS WHICH ARE SUBJECT TO CHANGE FROM TIME TO TIME. For the fullest, most current information on proper application, clean-up, mixing and other specifications and warranties, cautions and disclaimers, please refer to the Sto Corp. website. [www.stocorp.com](http://www.stocorp.com)





# StoTherm® ci

## Inside and Outside Corner with Common Substrate and Sto Mesh Reinforcement

Detail No.: 52s.54B  
Date: June 2022

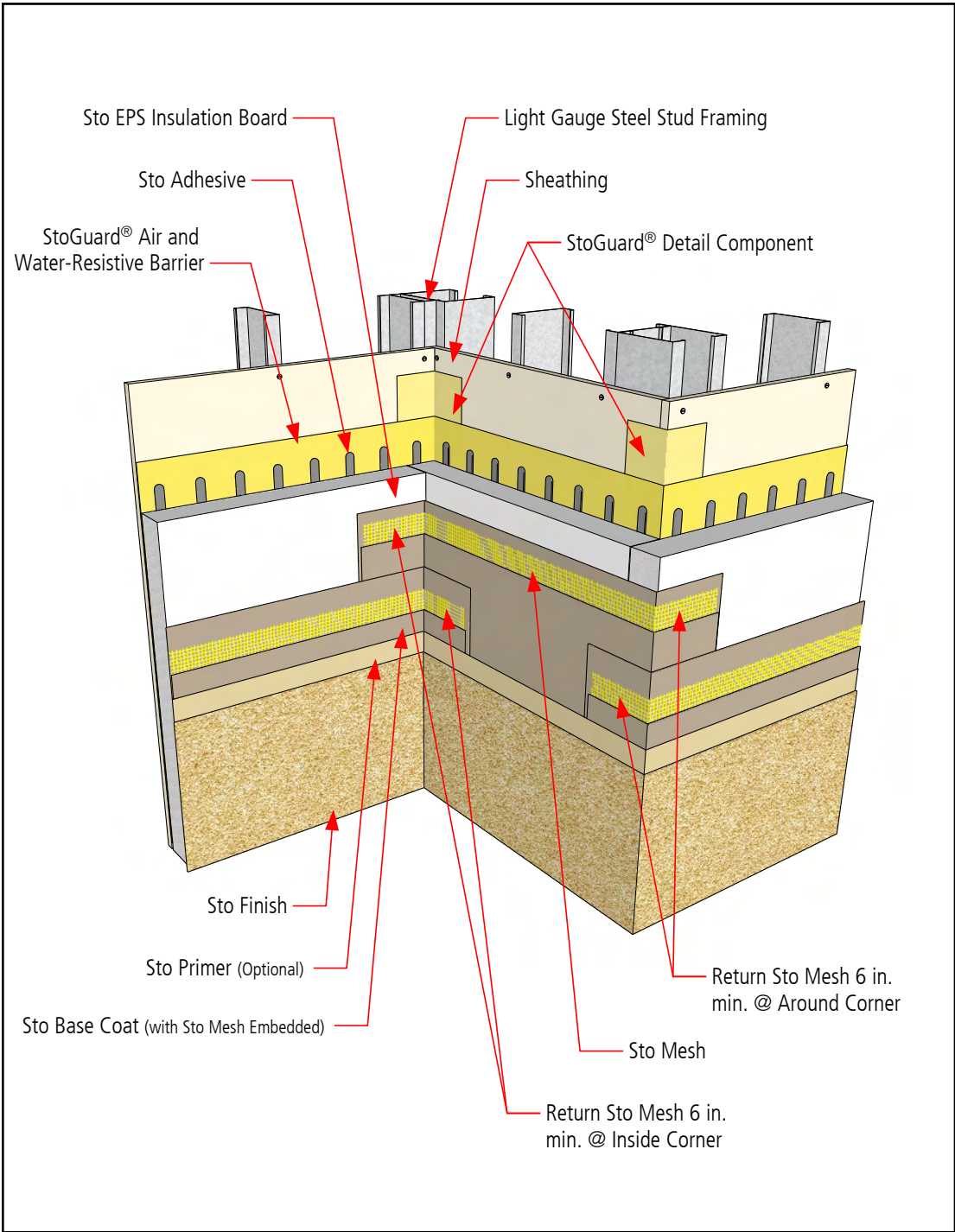

- Notes:
1. Refer to StoGuard Product Use Chart (Table 1.1) for StoGuard detail components; joint treatment, rough opening protection, backing for masonry anchors, or transitions to dissimilar materials, joints and seams in construction.
  2. Refer to General Notes for specific information and design guidance on wall assembly components.
  3. Components not identified as Sto are furnished by other manufacturers and are not necessarily installed by trades who install the Sto products. Refer to project specific contract documents.

**ATTENTION**

Property of Sto Corp. All Rights Reserved

[www.stocorp.com](http://www.stocorp.com)

Sto products are intended for use by qualified professional contractors, not consumers, as a component of a larger construction assembly as specified by a qualified design professional, general contractor or builder. They should be installed in accordance with those specifications and Sto's instructions. Sto Corp. disclaims all, and assumes no, liability for on-site inspections, for its products applied improperly, or by unqualified persons or entities, or as part of an improperly designed or constructed building, for the nonperformance of adjacent building components or assemblies, or for other construction activities beyond Sto's control. Improper use of Sto products or use as part of an improperly designed or constructed larger assembly or building may result in serious damage to Sto products, and to the structure of the building or its components.

STO CORP. DISCLAIMS ALL WARRANTIES EXPRESSED OR IMPLIED EXCEPT FOR EXPLICIT LIMITED WRITTEN WARRANTIES ISSUED TO AND ACCEPTED BY BUILDING OWNERS IN ACCORDANCE WITH STO'S WARRANTY PROGRAMS WHICH ARE SUBJECT TO CHANGE FROM TIME TO TIME. For the fullest, most current information on proper application, clean-up, mixing and other specifications and warranties, cautions and disclaimers, please refer to the Sto Corp. website. [www.stocorp.com](http://www.stocorp.com)



# StoTherm® ci Termination at Parapet - Front

Detail No.: 52s.60A  
Date: June 2022

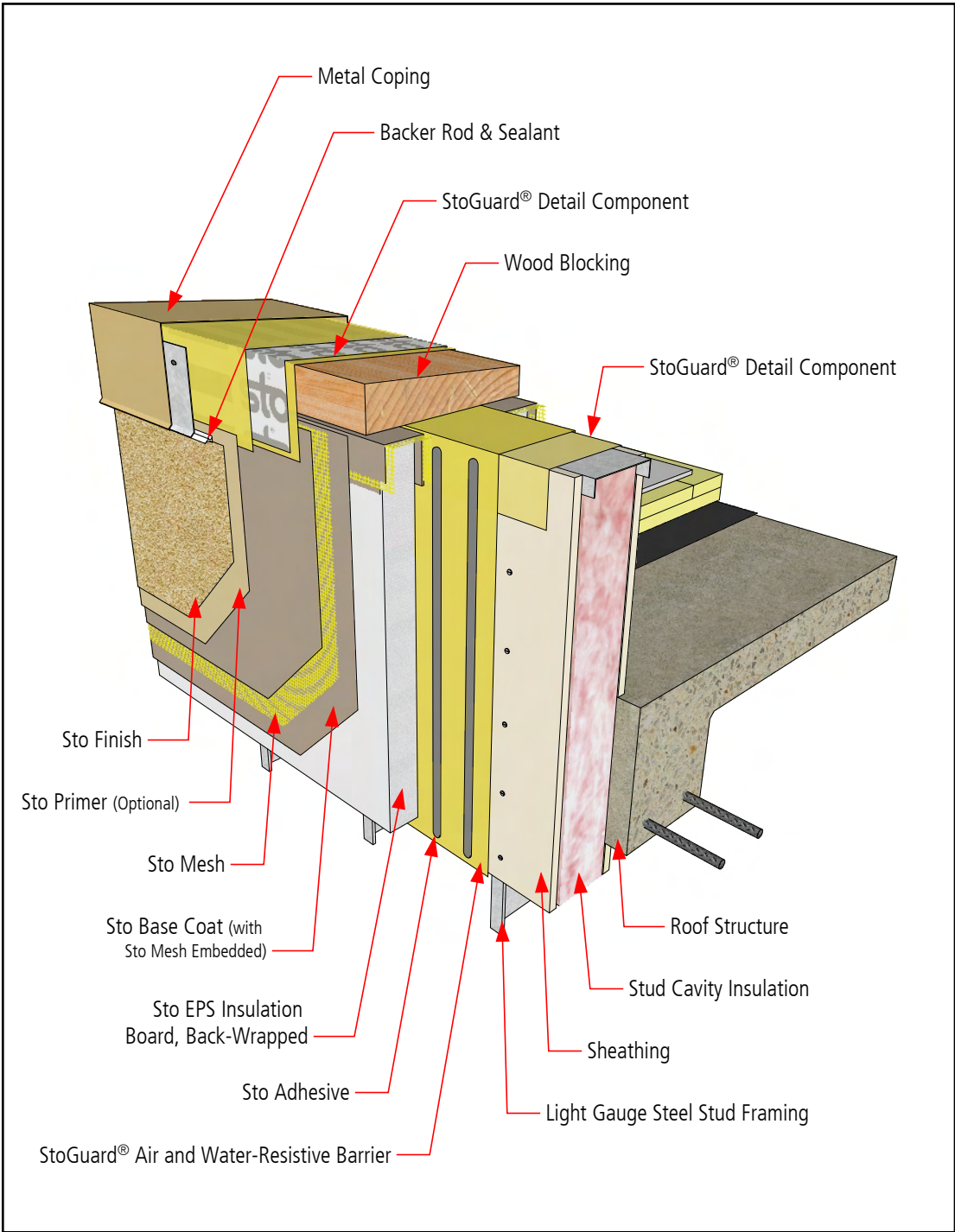

- Notes:
1. Refer to StoGuard Product Use Chart (Table 1.1) for StoGuard detail components; joint treatment, rough opening protection, backing for masonry anchors, or transitions to dissimilar materials, joints and seams in construction.
  2. Refer to General Notes for specific information and design guidance on wall assembly components.
  3. Components not identified as Sto are furnished by other manufacturers and are not necessarily installed by trades who install the Sto products. Refer to project specific contract documents.

**ATTENTION**

Property of Sto Corp. All Rights Reserved

[www.stocorp.com](http://www.stocorp.com)

Sto products are intended for use by qualified professional contractors, not consumers, as a component of a larger construction assembly as specified by a qualified design professional, general contractor or builder. They should be installed in accordance with those specifications and Sto's instructions. Sto Corp. disclaims all, and assumes no, liability for on-site inspections, for its products applied improperly, or by unqualified persons or entities, or as part of an improperly designed or constructed building, for the nonperformance of adjacent building components or assemblies, or for other construction activities beyond Sto's control. Improper use of Sto products or use as part of an improperly designed or constructed larger assembly or building may result in serious damage to Sto products, and to the structure of the building or its components.

STO CORP. DISCLAIMS ALL WARRANTIES EXPRESSED OR IMPLIED EXCEPT FOR EXPLICIT LIMITED WRITTEN WARRANTIES ISSUED TO AND ACCEPTED BY BUILDING OWNERS IN ACCORDANCE WITH STO'S WARRANTY PROGRAMS WHICH ARE SUBJECT TO CHANGE FROM TIME TO TIME. For the fullest, most current information on proper application, clean-up, mixing and other specifications and warranties, cautions and disclaimers, please refer to the Sto Corp. website. [www.stocorp.com](http://www.stocorp.com)



# StoTherm® ci Termination at Parapet - Back

Detail No.: 52s.60B  
Date: June 2022

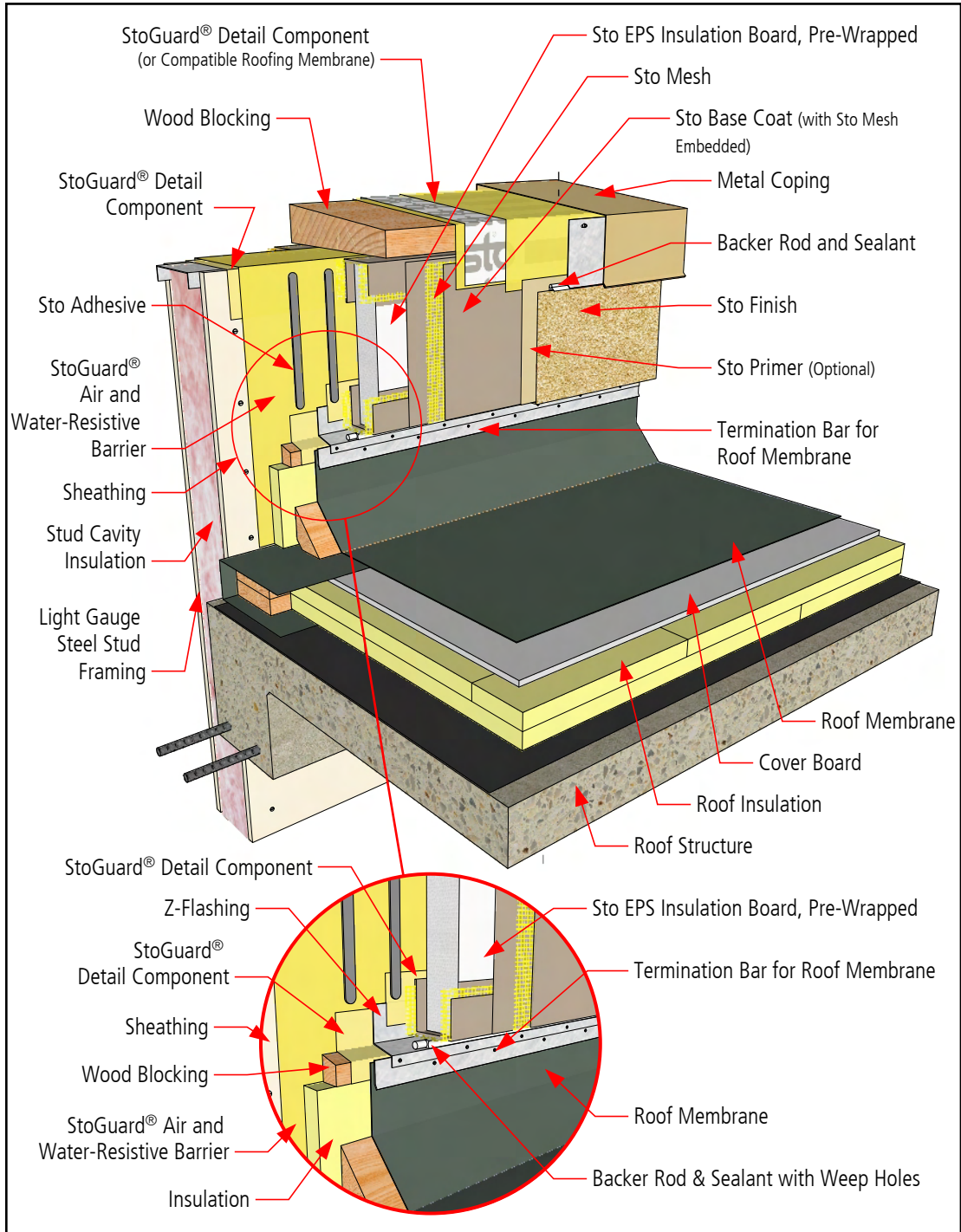

## Notes:

1. Refer to StoGuard Product Use Chart (Table 1.1) for StoGuard detail components; joint treatment, rough opening protection, backing for masonry anchors, or transitions to dissimilar materials, joints and seams in construction.
2. Refer to General Notes for specific information and design guidance on wall assembly components.
3. Components not identified as Sto are furnished by other manufacturers and are not necessarily installed by trades who install the Sto products. Refer to project specific contract documents.

## ATTENTION

Property of Sto Corp. All Rights Reserved

[www.stocorp.com](http://www.stocorp.com)

Sto products are intended for use by qualified professional contractors, not consumers, as a component of a larger construction assembly as specified by a qualified design professional, general contractor or builder. They should be installed in accordance with those specifications and Sto's instructions. Sto Corp. disclaims all, and assumes no, liability for on-site inspections, for its products applied improperly, or by unqualified persons or entities, or as part of an improperly designed or constructed building, for the nonperformance of adjacent building components or assemblies, or for other construction activities beyond Sto's control. Improper use of Sto products or use as part of an improperly designed or constructed larger assembly or building may result in serious damage to Sto products, and to the structure of the building or its components.

STO CORP. DISCLAIMS ALL WARRANTIES EXPRESSED OR IMPLIED EXCEPT FOR EXPLICIT LIMITED WRITTEN WARRANTIES ISSUED TO AND ACCEPTED BY BUILDING OWNERS IN ACCORDANCE WITH STO'S WARRANTY PROGRAMS WHICH ARE SUBJECT TO CHANGE FROM TIME TO TIME. For the fullest, most current information on proper application, clean-up, mixing and other specifications and warranties, cautions and disclaimers, please refer to the Sto Corp. website. [www.stocorp.com](http://www.stocorp.com)



# StoTherm® ci Parapet with Cornice Feature

Detail No.: 52s.61  
Date: June 2022

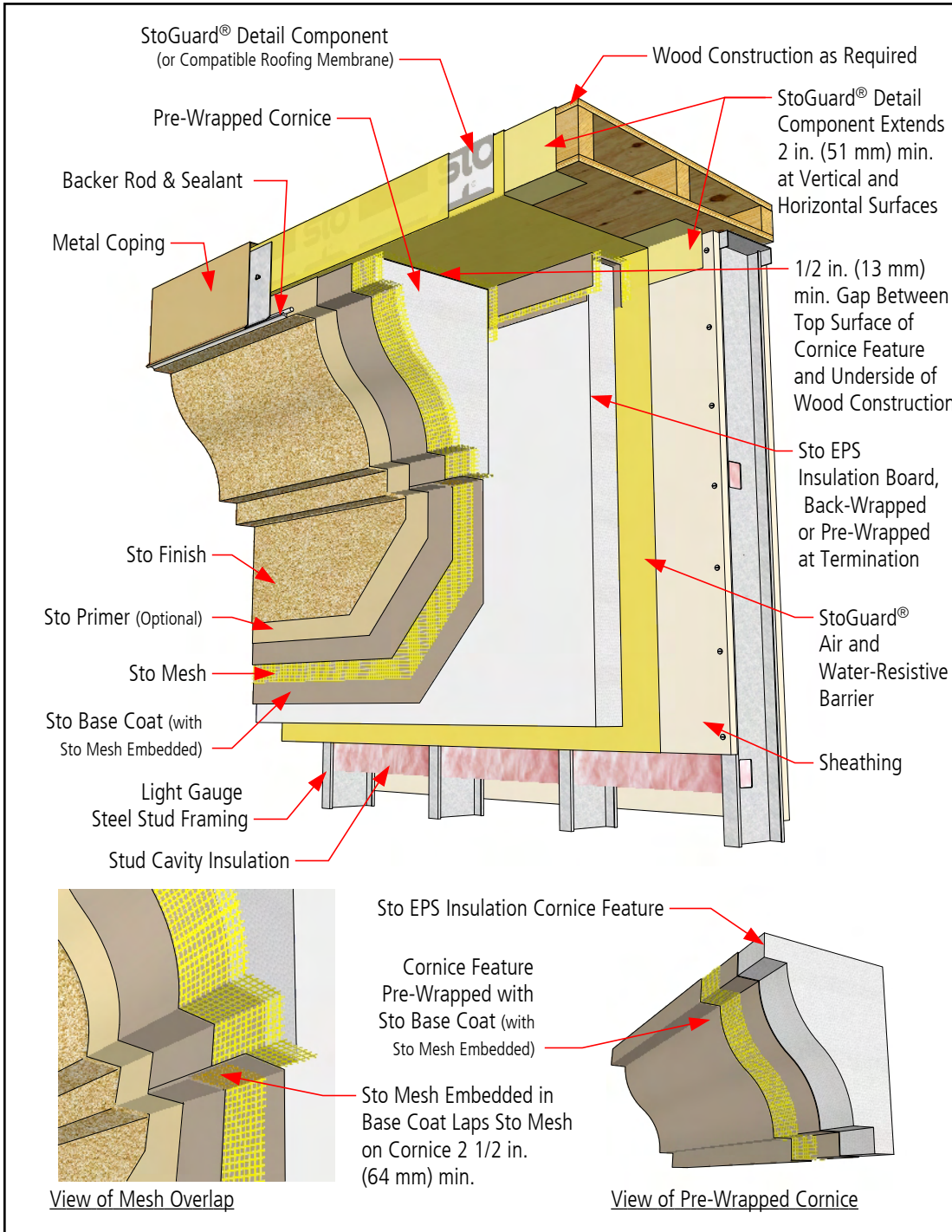

- Notes:
1. Refer to StoGuard Product Use Chart (Table 1.1) for StoGuard detail components; joint treatment, rough opening protection, backing for masonry anchors, or transitions to dissimilar materials, joints and seams in construction.
  2. Refer to General Notes for specific information and design guidance on wall assembly components.
  3. Components not identified as Sto are furnished by other manufacturers and are not necessarily installed by trades who install the Sto products. Refer to project specific contract documents.

**ATTENTION**

Property of Sto Corp. All Rights Reserved

[www.stocorp.com](http://www.stocorp.com)

Sto products are intended for use by qualified professional contractors, not consumers, as a component of a larger construction assembly as specified by a qualified design professional, general contractor or builder. They should be installed in accordance with those specifications and Sto's instructions. Sto Corp. disclaims all, and assumes no, liability for on-site inspections, for its products applied improperly, or by unqualified persons or entities, or as part of an improperly designed or constructed building, for the nonperformance of adjacent building components or assemblies, or for other construction activities beyond Sto's control. Improper use of Sto products or use as part of an improperly designed or constructed larger assembly or building may result in serious damage to Sto products, and to the structure of the building or its components.

STO CORP. DISCLAIMS ALL WARRANTIES EXPRESSED OR IMPLIED EXCEPT FOR EXPLICIT LIMITED WRITTEN WARRANTIES ISSUED TO AND ACCEPTED BY BUILDING OWNERS IN ACCORDANCE WITH STO'S WARRANTY PROGRAMS WHICH ARE SUBJECT TO CHANGE FROM TIME TO TIME. For the fullest, most current information on proper application, clean-up, mixing and other specifications and warranties, cautions and disclaimers, please refer to the Sto Corp. website. [www.stocorp.com](http://www.stocorp.com)



# StoTherm® ci Diverter Flashing at Roof/Wall Abutment

Detail No.: 52s.62  
Date: June 2022

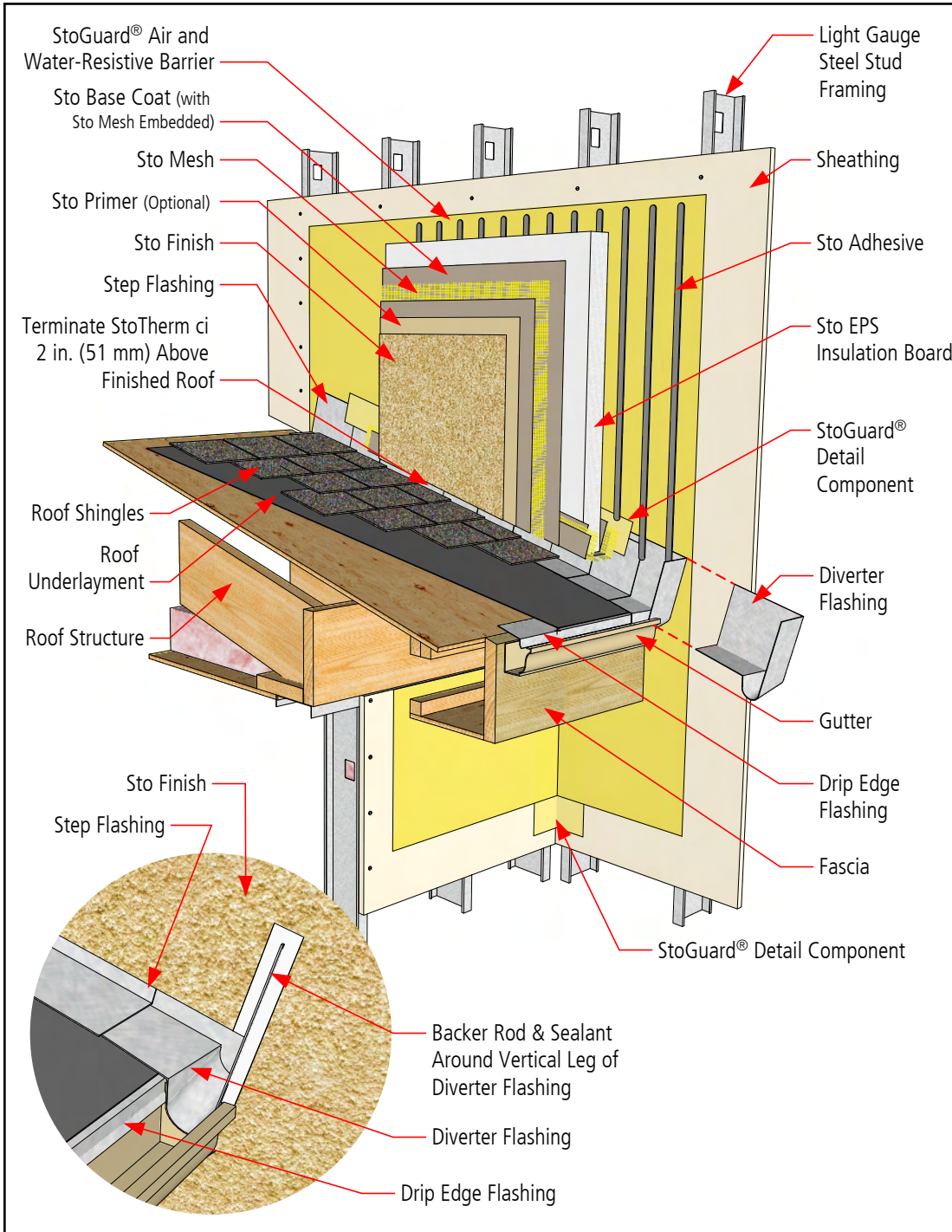

- Notes:**
1. Refer to StoGuard Product Use Chart (Table 1.1) for StoGuard detail components; joint treatment, rough opening protection, backing for masonry anchors, or transitions to dissimilar materials, joints and seams in construction.
  2. Refer to General Notes for specific information and design guidance on wall assembly components.
  3. Components not identified as Sto are furnished by other manufacturers and are not necessarily installed by trades who install the Sto products. Refer to project specific contract documents.

**ATTENTION**

Property of Sto Corp. All Rights Reserved

[www.stocorp.com](http://www.stocorp.com)

Sto products are intended for use by qualified professional contractors, not consumers, as a component of a larger construction assembly as specified by a qualified design professional, general contractor or builder. They should be installed in accordance with those specifications and Sto's instructions. Sto Corp. disclaims all, and assumes no, liability for on-site inspections, for its products applied improperly, or by unqualified persons or entities, or as part of an improperly designed or constructed building, for the nonperformance of adjacent building components or assemblies, or for other construction activities beyond Sto's control. Improper use of Sto products or use as part of an improperly designed or constructed larger assembly or building may result in serious damage to Sto products, and to the structure of the building or its components.

STO CORP. DISCLAIMS ALL WARRANTIES EXPRESSED OR IMPLIED EXCEPT FOR EXPLICIT LIMITED WRITTEN WARRANTIES ISSUED TO AND ACCEPTED BY BUILDING OWNERS IN ACCORDANCE WITH STO'S WARRANTY PROGRAMS WHICH ARE SUBJECT TO CHANGE FROM TIME TO TIME. For the fullest, most current information on proper application, clean-up, mixing and other specifications and warranties, cautions and disclaimers, please refer to the Sto Corp. website. [www.stocorp.com](http://www.stocorp.com)



# StoTherm® ci Gravel Stop

Detail No.: 52s.63  
Date: June 2022

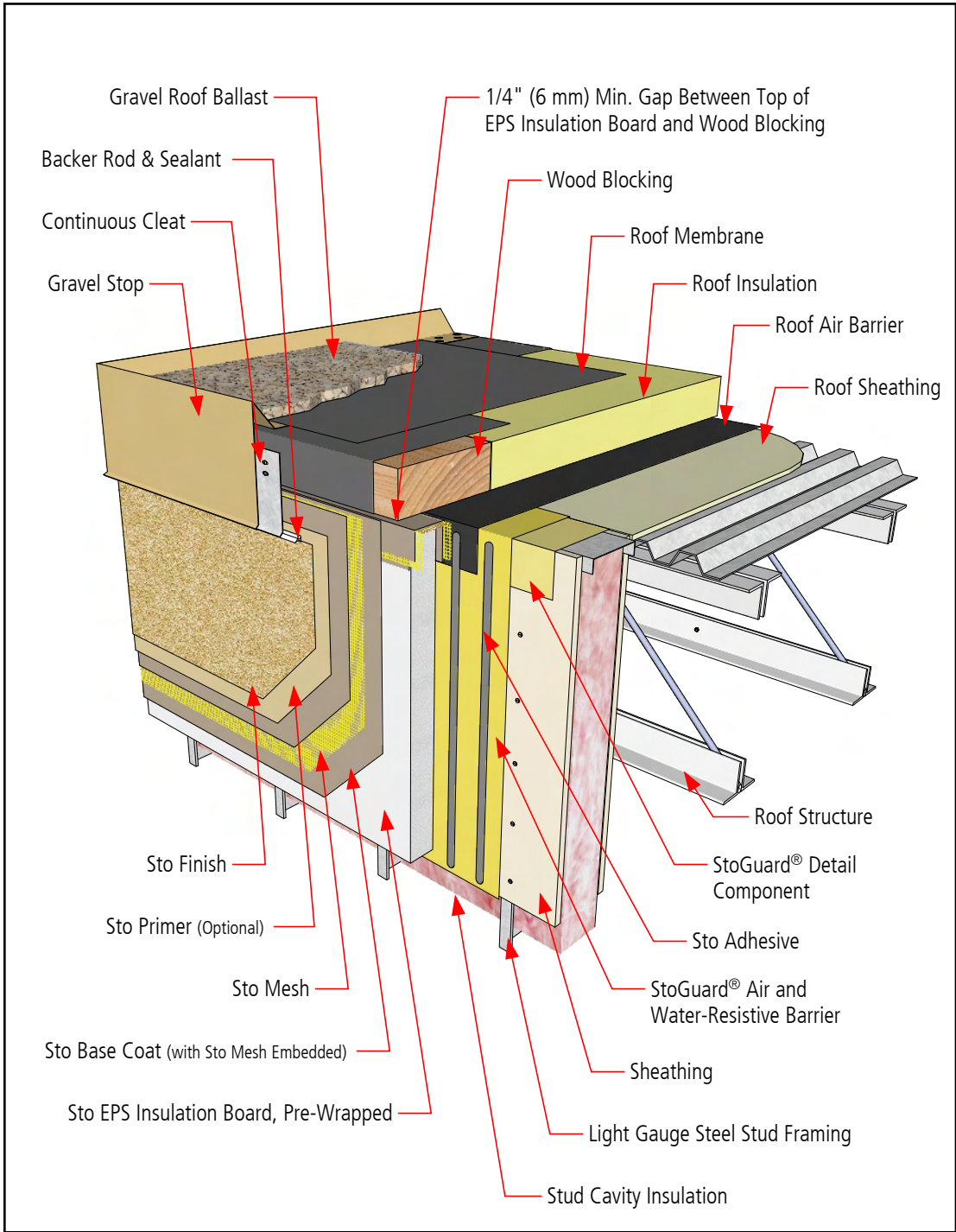

- Notes:**
1. Refer to StoGuard Product Use Chart (Table 1.1) for StoGuard detail components; joint treatment, rough opening protection, backing for masonry anchors, or transitions to dissimilar materials, joints and seams in construction.
  2. Refer to General Notes for specific information and design guidance on wall assembly components.
  3. Components not identified as Sto are furnished by other manufacturers and are not necessarily installed by trades who install the Sto products. Refer to project specific contract documents.

**ATTENTION**

Property of Sto Corp. All Rights Reserved

Sto products are intended for use by qualified professional contractors, not consumers, as a component of a larger construction assembly as specified by a qualified design professional, general contractor or builder. They should be installed in accordance with those specifications and Sto's instructions. Sto Corp. disclaims all, and assumes no, liability for on-site inspections, for its products applied improperly, or by unqualified persons or entities, or as part of an improperly designed or constructed building, for the nonperformance of adjacent building components or assemblies, or for other construction activities beyond Sto's control. Improper use of Sto products or use as part of an improperly designed or constructed larger assembly or building may result in serious damage to Sto products, and to the structure of the building or its components.

STO CORP. DISCLAIMS ALL WARRANTIES EXPRESSED OR IMPLIED EXCEPT FOR EXPLICIT LIMITED WRITTEN WARRANTIES ISSUED TO AND ACCEPTED BY BUILDING OWNERS IN ACCORDANCE WITH STO'S WARRANTY PROGRAMS WHICH ARE SUBJECT TO CHANGE FROM TIME TO TIME. For the fullest, most current information on proper application, clean-up, mixing and other specifications and warranties, cautions and disclaimers, please refer to the Sto Corp. website. [www.stocorp.com](http://www.stocorp.com)

[www.stocorp.com](http://www.stocorp.com)



# StoTherm® ci

## Saddle Flashing at Lower/Higher Wall Abutment

Detail No.: 52s.64-1  
Date: June 2022

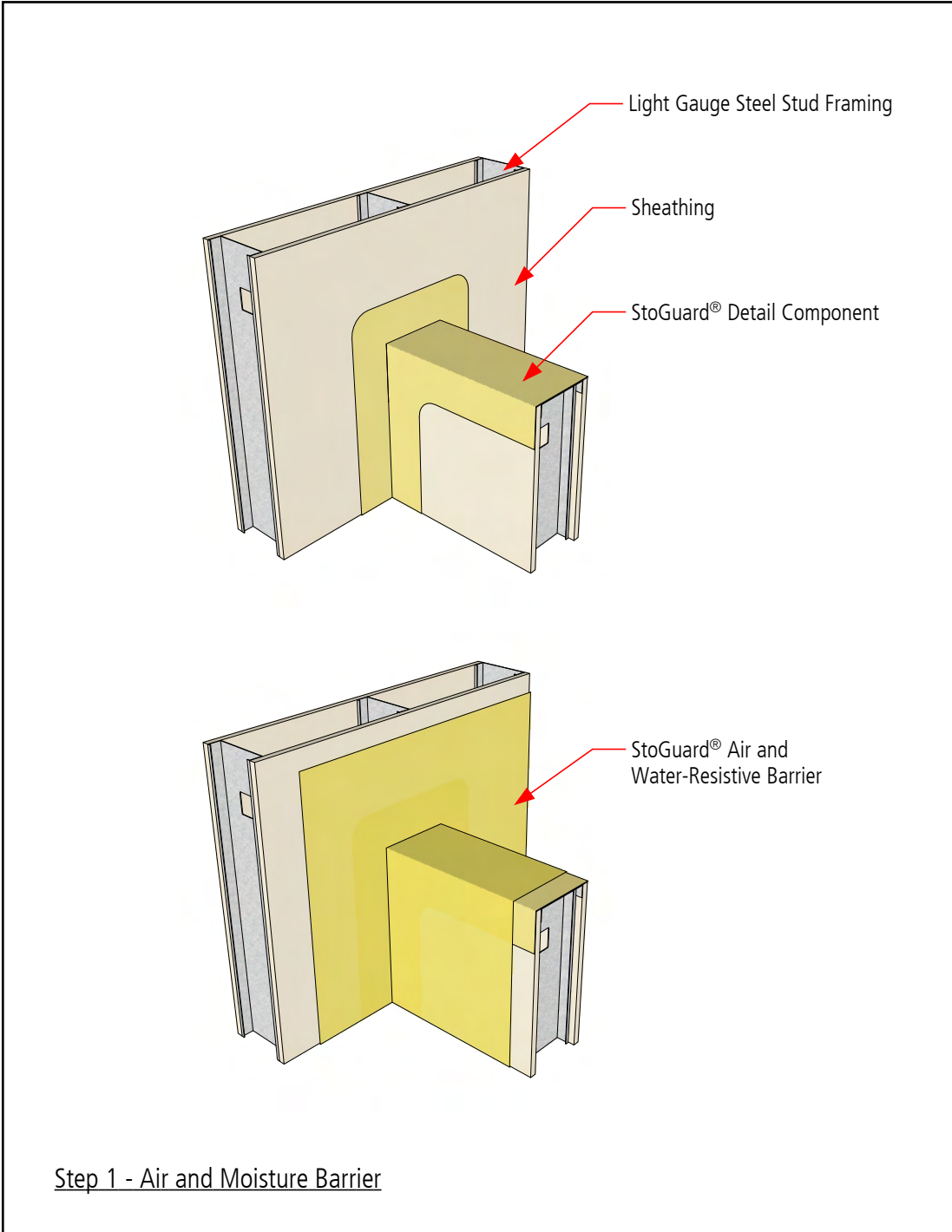

Notes:

1. Refer to StoGuard Product Use Chart (Table 1.1) for StoGuard detail components; joint treatment, rough opening protection, backing for masonry anchors, or transitions to dissimilar materials, joints and seams in construction.
2. Refer to General Notes for specific information and design guidance on wall assembly components.
3. Components not identified as Sto are furnished by other manufacturers and are not necessarily installed by trades who install the Sto products. Refer to project specific contract documents.

**ATTENTION**

Property of Sto Corp. All Rights Reserved

Sto products are intended for use by qualified professional contractors, not consumers, as a component of a larger construction assembly as specified by a qualified design professional, general contractor or builder. They should be installed in accordance with those specifications and Sto's instructions. Sto Corp. disclaims all, and assumes no, liability for on-site inspections, for its products applied improperly, or by unqualified persons or entities, or as part of an improperly designed or constructed building, for the nonperformance of adjacent building components or assemblies, or for other construction activities beyond Sto's control. Improper use of Sto products or use as part of an improperly designed or constructed larger assembly or building may result in serious damage to Sto products, and to the structure of the building or its components.

STO CORP. DISCLAIMS ALL WARRANTIES EXPRESSED OR IMPLIED EXCEPT FOR EXPLICIT LIMITED WRITTEN WARRANTIES ISSUED TO AND ACCEPTED BY BUILDING OWNERS IN ACCORDANCE WITH STO'S WARRANTY PROGRAMS WHICH ARE SUBJECT TO CHANGE FROM TIME TO TIME. For the fullest, most current information on proper application, clean-up, mixing and other specifications and warranties, cautions and disclaimers, please refer to the Sto Corp. website. [www.stocorp.com](http://www.stocorp.com)

[www.stocorp.com](http://www.stocorp.com)



# StoTherm® ci

## Saddle Flashing at Lower/Higher Wall Abutment

Detail No.: 52s.64-2  
Date: June 2022

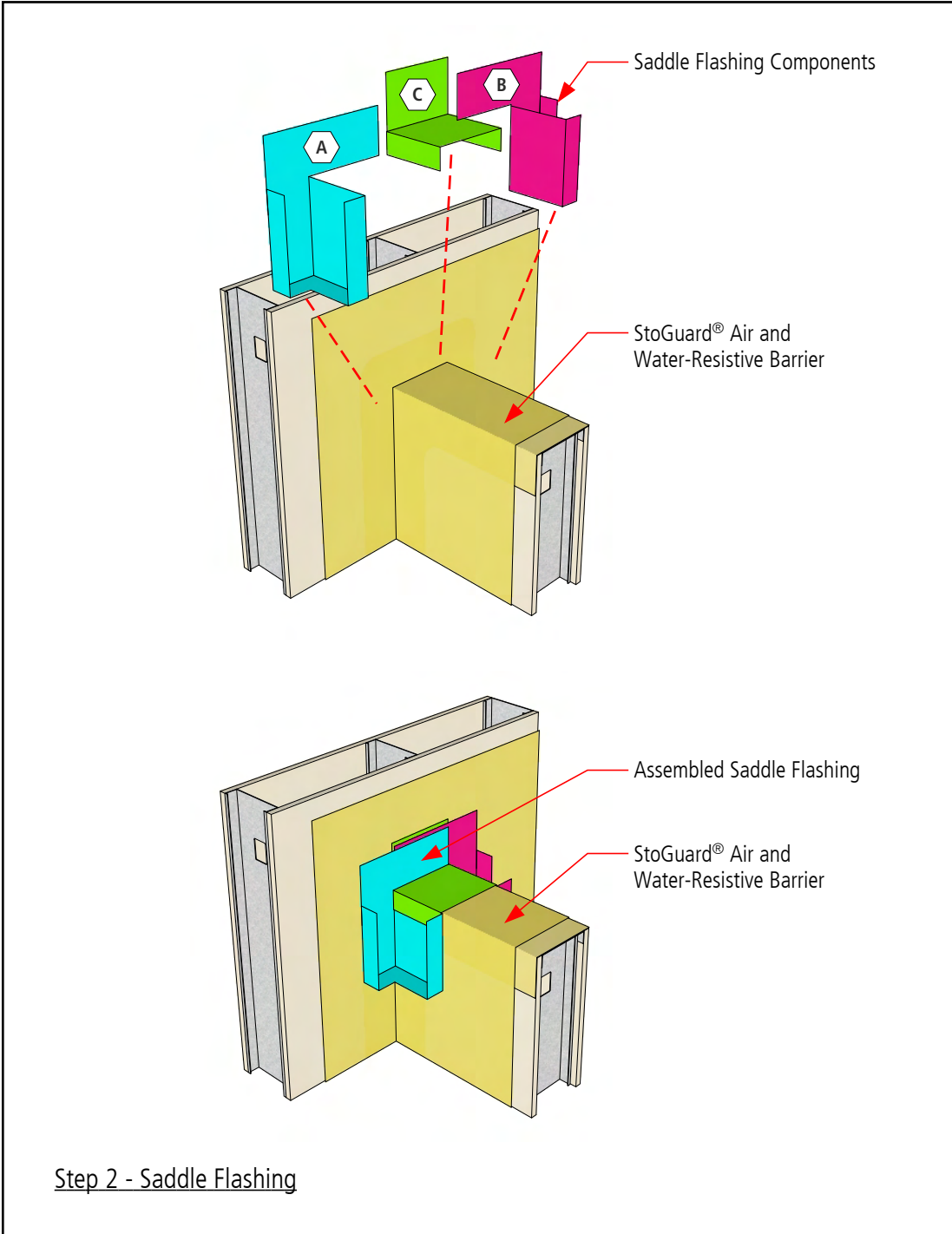

- Notes:
1. Refer to StoGuard Product Use Chart (Table 1.1) for StoGuard detail components; joint treatment, rough opening protection, backing for masonry anchors, or transitions to dissimilar materials, joints and seams in construction.
  2. Refer to General Notes for specific information and design guidance on wall assembly components.
  3. Components not identified as Sto are furnished by other manufacturers and are not necessarily installed by trades who install the Sto products. Refer to project specific contract documents.

**ATTENTION**

Property of Sto Corp. All Rights Reserved

[www.stocorp.com](http://www.stocorp.com)

Sto products are intended for use by qualified professional contractors, not consumers, as a component of a larger construction assembly as specified by a qualified design professional, general contractor or builder. They should be installed in accordance with those specifications and Sto's instructions. Sto Corp. disclaims all, and assumes no, liability for on-site inspections, for its products applied improperly, or by unqualified persons or entities, or as part of an improperly designed or constructed building, for the nonperformance of adjacent building components or assemblies, or for other construction activities beyond Sto's control. Improper use of Sto products or use as part of an improperly designed or constructed larger assembly or building may result in serious damage to Sto products, and to the structure of the building or its components.

STO CORP. DISCLAIMS ALL WARRANTIES EXPRESSED OR IMPLIED EXCEPT FOR EXPLICIT LIMITED WRITTEN WARRANTIES ISSUED TO AND ACCEPTED BY BUILDING OWNERS IN ACCORDANCE WITH STO'S WARRANTY PROGRAMS WHICH ARE SUBJECT TO CHANGE FROM TIME TO TIME. For the fullest, most current information on proper application, clean-up, mixing and other specifications and warranties, cautions and disclaimers, please refer to the Sto Corp. website. [www.stocorp.com](http://www.stocorp.com)





# StoTherm® ci Saddle Flashing at Lower/Higher Wall Abutment

Detail No.: 52s.64-3  
Date: June 2022

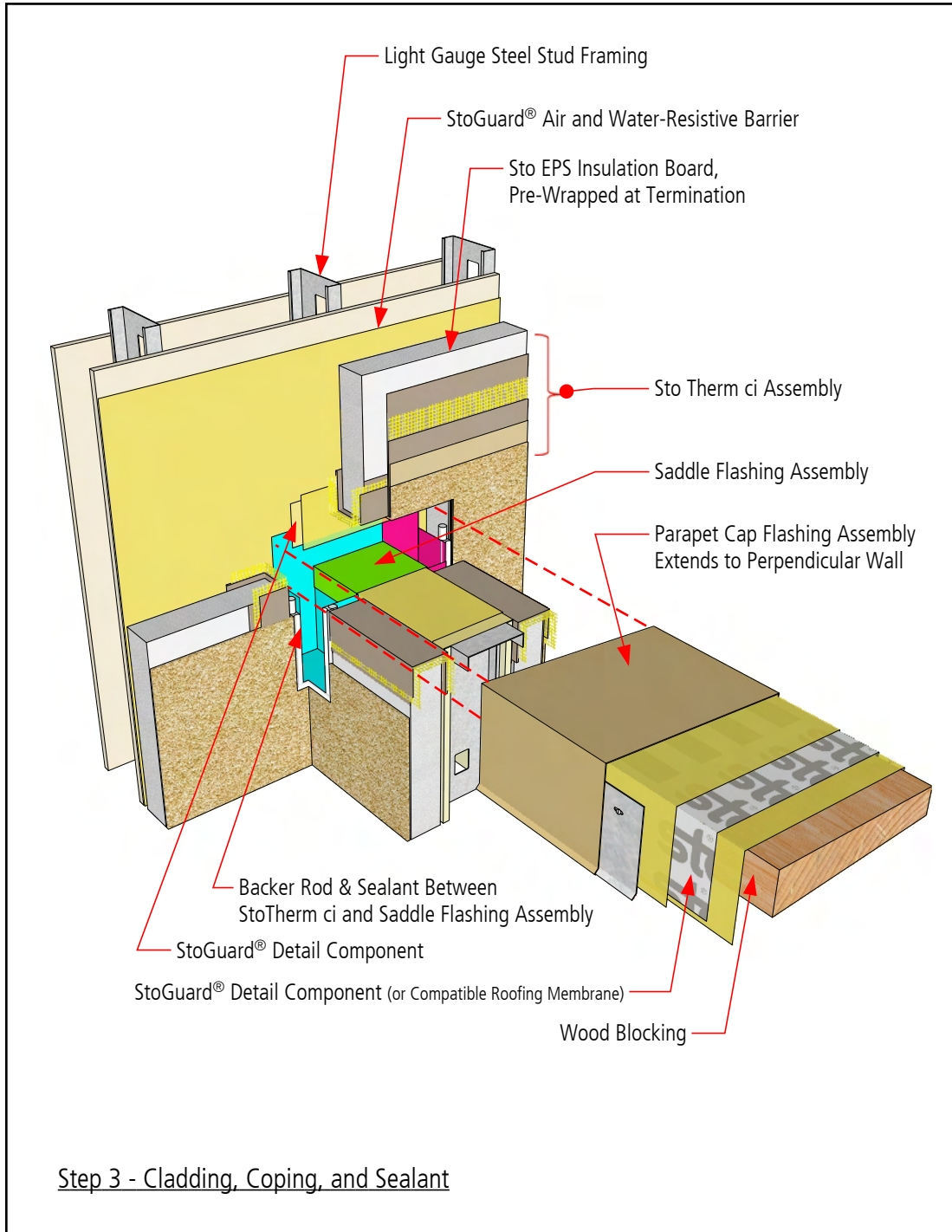

### Notes:

1. Refer to StoGuard Product Use Chart (Table 1.1) for StoGuard detail components; joint treatment, rough opening protection, backing for masonry anchors, or transitions to dissimilar materials, joints and seams in construction.
2. Refer to General Notes for specific information and design guidance on wall assembly components.
3. Components not identified as Sto are furnished by other manufacturers and are not necessarily installed by trades who install the Sto products. Refer to project specific contract documents.

### ATTENTION

Property of Sto Corp. All Rights Reserved

Sto products are intended for use by qualified professional contractors, not consumers, as a component of a larger construction assembly as specified by a qualified design professional, general contractor or builder. They should be installed in accordance with those specifications and Sto's instructions. Sto Corp. disclaims all, and assumes no, liability for on-site inspections, for its products applied improperly, or by unqualified persons or entities, or as part of an improperly designed or constructed building, for the nonperformance of adjacent building components or assemblies, or for other construction activities beyond Sto's control. Improper use of Sto products or use as part of an improperly designed or constructed larger assembly or building may result in serious damage to Sto products, and to the structure of the building or its components.

STO CORP. DISCLAIMS ALL WARRANTIES EXPRESSED OR IMPLIED EXCEPT FOR EXPLICIT LIMITED WRITTEN WARRANTIES ISSUED TO AND ACCEPTED BY BUILDING OWNERS IN ACCORDANCE WITH STO'S WARRANTY PROGRAMS WHICH ARE SUBJECT TO CHANGE FROM TIME TO TIME. For the fullest, most current information on proper application, clean-up, mixing and other specifications and warranties, cautions and disclaimers, please refer to the Sto Corp. website. [www.stocorp.com](http://www.stocorp.com)

[www.stocorp.com](http://www.stocorp.com)



# StoTherm® ci Scupper Penetration

Detail No.: 52s.65  
Date: June 2022

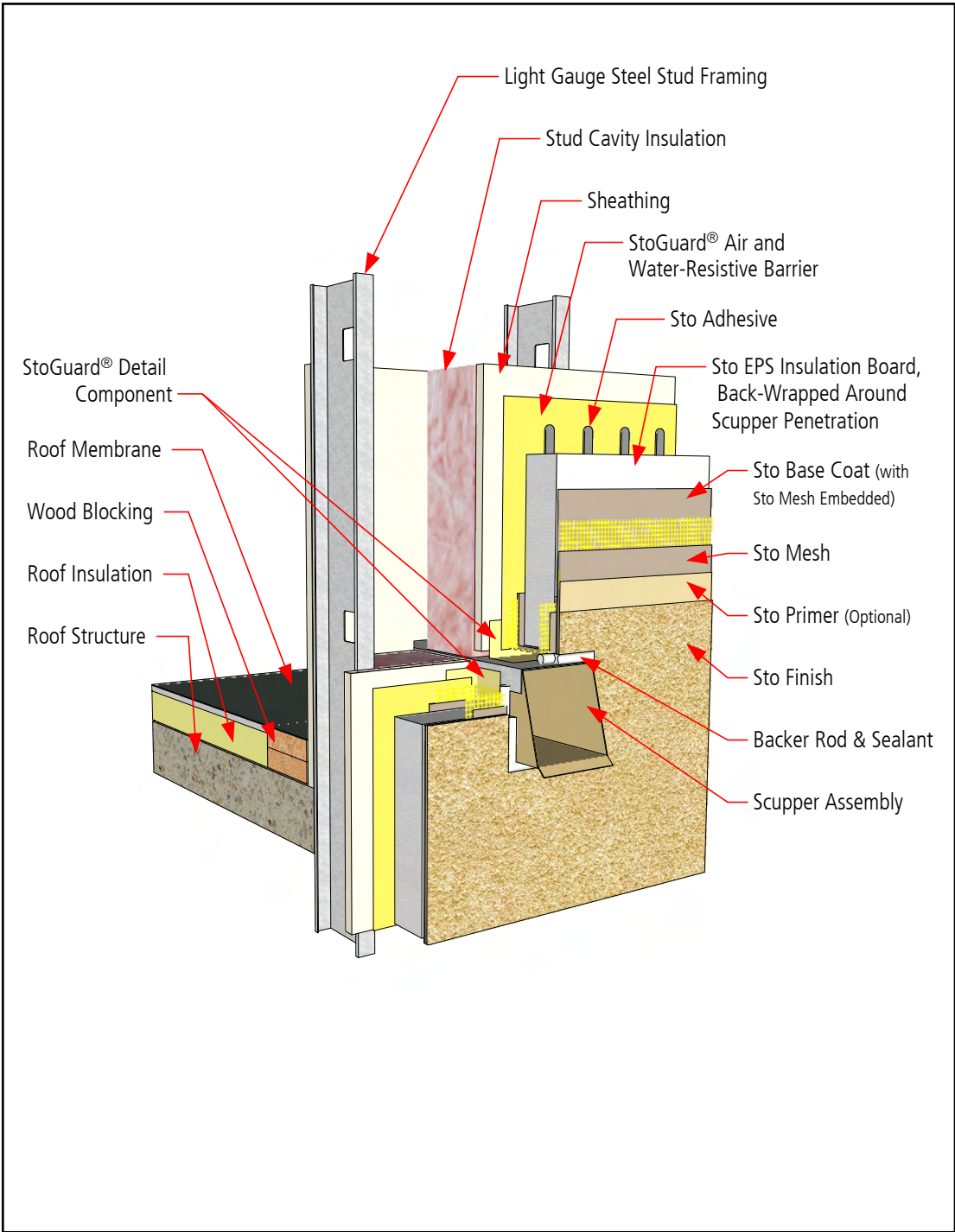

Notes:

1. Refer to StoGuard Product Use Chart (Table 1.1) for StoGuard detail components; joint treatment, rough opening protection, backing for masonry anchors, or transitions to dissimilar materials, joints and seams in construction.
2. Refer to General Notes for specific information and design guidance on wall assembly components.
3. Components not identified as Sto are furnished by other manufacturers and are not necessarily installed by trades who install the Sto products. Refer to project specific contract documents.

**ATTENTION**

Property of Sto Corp. All Rights Reserved

[www.stocorp.com](http://www.stocorp.com)

Sto products are intended for use by qualified professional contractors, not consumers, as a component of a larger construction assembly as specified by a qualified design professional, general contractor or builder. They should be installed in accordance with those specifications and Sto's instructions. Sto Corp. disclaims all, and assumes no, liability for on-site inspections, for its products applied improperly, or by unqualified persons or entities, or as part of an improperly designed or constructed building, for the nonperformance of adjacent building components or assemblies, or for other construction activities beyond Sto's control. Improper use of Sto products or use as part of an improperly designed or constructed larger assembly or building may result in serious damage to Sto products, and to the structure of the building or its components.

STO CORP. DISCLAIMS ALL WARRANTIES EXPRESSED OR IMPLIED EXCEPT FOR EXPLICIT LIMITED WRITTEN WARRANTIES ISSUED TO AND ACCEPTED BY BUILDING OWNERS IN ACCORDANCE WITH STO'S WARRANTY PROGRAMS WHICH ARE SUBJECT TO CHANGE FROM TIME TO TIME. For the fullest, most current information on proper application, clean-up, mixing and other specifications and warranties, cautions and disclaimers, please refer to the Sto Corp. website. [www.stocorp.com](http://www.stocorp.com)



# StoTherm® ci

## Pipe Penetration - Precision Cut Sheathing

Detail No.: 52s.70A  
Date: June 2022

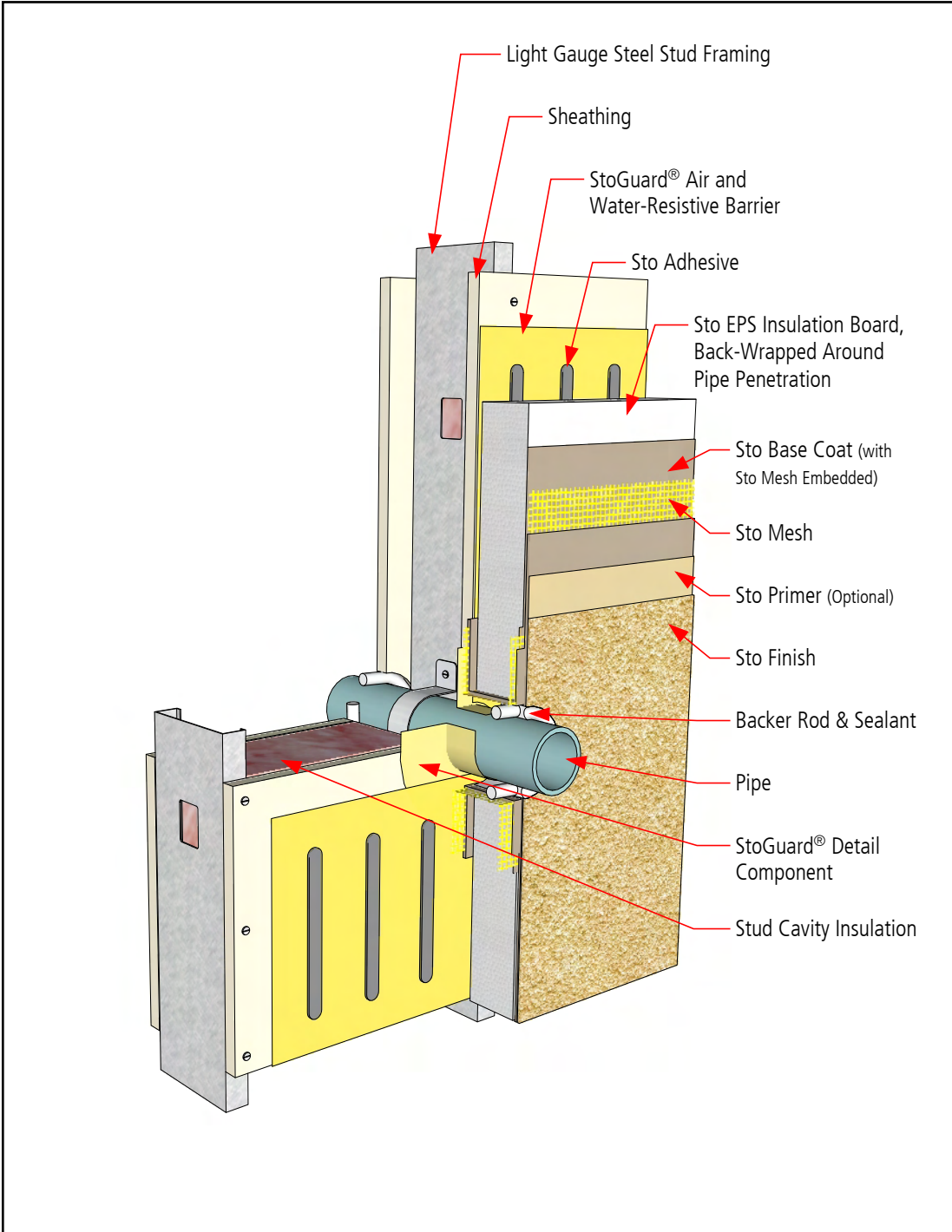

- Notes:
1. Refer to StoGuard Product Use Chart (Table 1.1) for StoGuard detail components; joint treatment, rough opening protection, backing for masonry anchors, or transitions to dissimilar materials, joints and seams in construction.
  2. Refer to General Notes for specific information and design guidance on wall assembly components.
  3. Components not identified as Sto are furnished by other manufacturers and are not necessarily installed by trades who install the Sto products. Refer to project specific contract documents.

**ATTENTION**

Property of Sto Corp. All Rights Reserved

[www.stocorp.com](http://www.stocorp.com)

Sto products are intended for use by qualified professional contractors, not consumers, as a component of a larger construction assembly as specified by a qualified design professional, general contractor or builder. They should be installed in accordance with those specifications and Sto's instructions. Sto Corp. disclaims all, and assumes no, liability for on-site inspections, for its products applied improperly, or by unqualified persons or entities, or as part of an improperly designed or constructed building, for the nonperformance of adjacent building components or assemblies, or for other construction activities beyond Sto's control. Improper use of Sto products or use as part of an improperly designed or constructed larger assembly or building may result in serious damage to Sto products, and to the structure of the building or its components.

STO CORP. DISCLAIMS ALL WARRANTIES EXPRESSED OR IMPLIED EXCEPT FOR EXPLICIT LIMITED WRITTEN WARRANTIES ISSUED TO AND ACCEPTED BY BUILDING OWNERS IN ACCORDANCE WITH STO'S WARRANTY PROGRAMS WHICH ARE SUBJECT TO CHANGE FROM TIME TO TIME. For the fullest, most current information on proper application, clean-up, mixing and other specifications and warranties, cautions and disclaimers, please refer to the Sto Corp. website. [www.stocorp.com](http://www.stocorp.com)



# StoTherm® ci Pipe Penetration - Rough Cut Sheathing

Detail No.: 52s.70B  
Date: June 2022

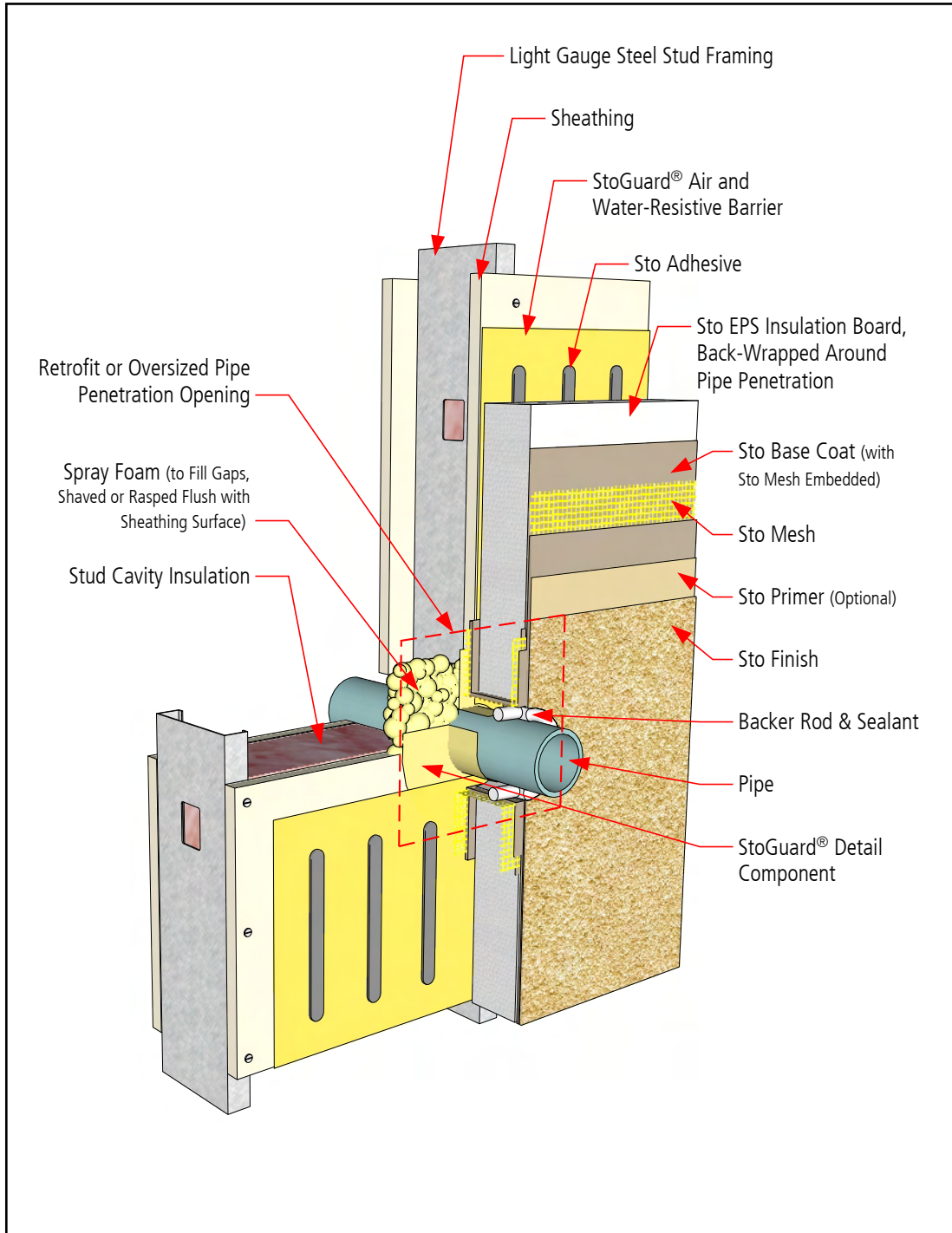

### Notes:

1. Refer to StoGuard Product Use Chart (Table 1.1) for StoGuard detail components; joint treatment, rough opening protection, backing for masonry anchors, or transitions to dissimilar materials, joints and seams in construction.
2. Refer to General Notes for specific information and design guidance on wall assembly components.
3. Components not identified as Sto are furnished by other manufacturers and are not necessarily installed by trades who install the Sto products. Refer to project specific contract documents.

### ATTENTION

Property of Sto Corp. All Rights Reserved

Sto products are intended for use by qualified professional contractors, not consumers, as a component of a larger construction assembly as specified by a qualified design professional, general contractor or builder. They should be installed in accordance with those specifications and Sto's instructions. Sto Corp. disclaims all, and assumes no, liability for on-site inspections, for its products applied improperly, or by unqualified persons or entities, or as part of an improperly designed or constructed building, for the nonperformance of adjacent building components or assemblies, or for other construction activities beyond Sto's control. Improper use of Sto products or use as part of an improperly designed or constructed larger assembly or building may result in serious damage to Sto products, and to the structure of the building or its components.

STO CORP. DISCLAIMS ALL WARRANTIES EXPRESSED OR IMPLIED EXCEPT FOR EXPLICIT LIMITED WRITTEN WARRANTIES ISSUED TO AND ACCEPTED BY BUILDING OWNERS IN ACCORDANCE WITH STO'S WARRANTY PROGRAMS WHICH ARE SUBJECT TO CHANGE FROM TIME TO TIME. For the fullest, most current information on proper application, clean-up, mixing and other specifications and warranties, cautions and disclaimers, please refer to the Sto Corp. website. [www.stocorp.com](http://www.stocorp.com)

[www.stocorp.com](http://www.stocorp.com)



# StoTherm® ci Sign Attachment

Detail No.: 52s.71  
Date: June 2022

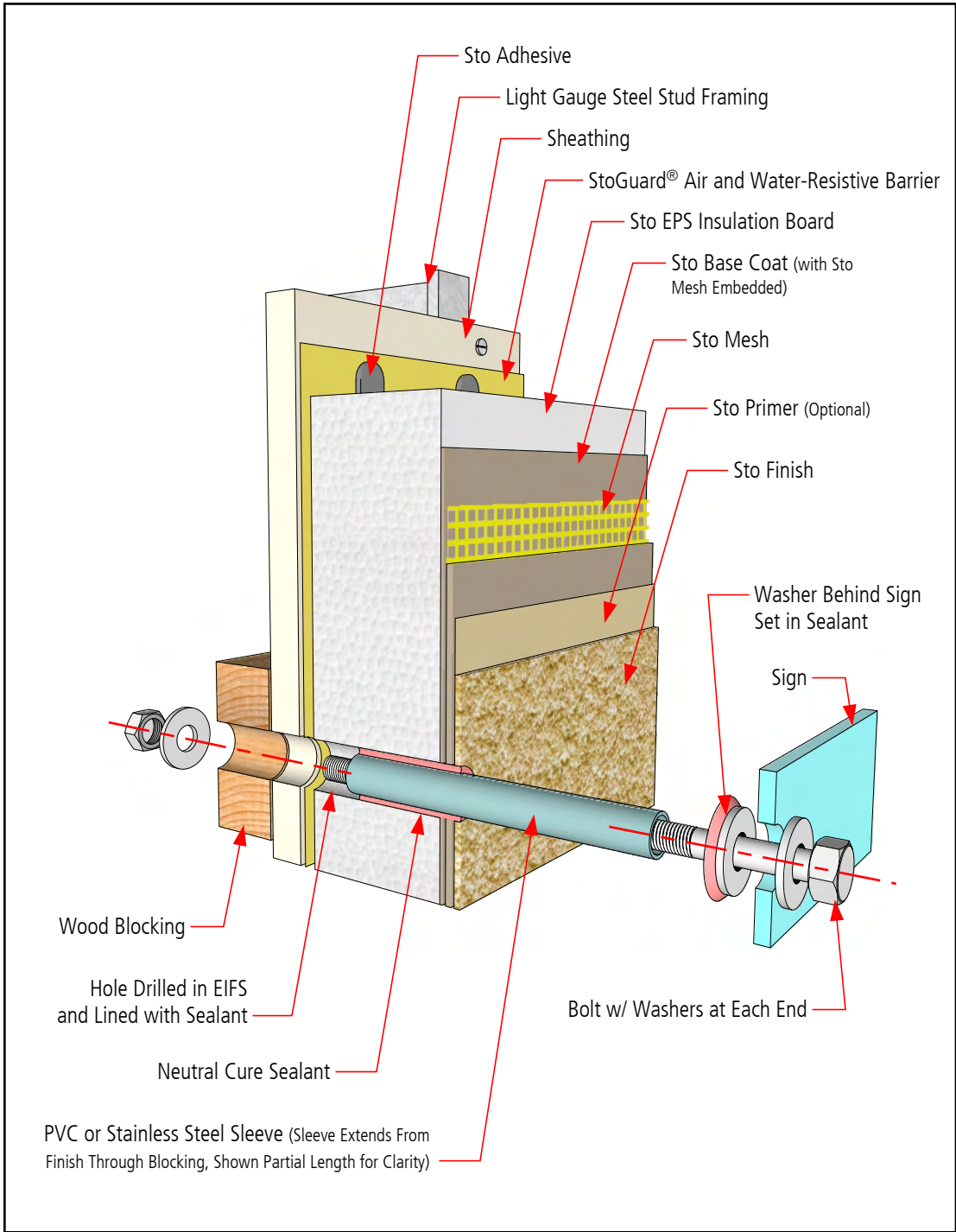

- Notes:
1. Refer to StoGuard Product Use Chart (Table 1.1) for StoGuard detail components; joint treatment, rough opening protection, backing for masonry anchors, or transitions to dissimilar materials, joints and seams in construction.
  2. Refer to General Notes for specific information and design guidance on wall assembly components.
  3. Components not identified as Sto are furnished by other manufacturers and are not necessarily installed by trades who install the Sto products. Refer to project specific contract documents.

**ATTENTION**

Property of Sto Corp. All Rights Reserved

[www.stocorp.com](http://www.stocorp.com)

Sto products are intended for use by qualified professional contractors, not consumers, as a component of a larger construction assembly as specified by a qualified design professional, general contractor or builder. They should be installed in accordance with those specifications and Sto's instructions. Sto Corp. disclaims all, and assumes no, liability for on-site inspections, for its products applied improperly, or by unqualified persons or entities, or as part of an improperly designed or constructed building, for the nonperformance of adjacent building components or assemblies, or for other construction activities beyond Sto's control. Improper use of Sto products or use as part of an improperly designed or constructed larger assembly or building may result in serious damage to Sto products, and to the structure of the building or its components.

STO CORP. DISCLAIMS ALL WARRANTIES EXPRESSED OR IMPLIED EXCEPT FOR EXPLICIT LIMITED WRITTEN WARRANTIES ISSUED TO AND ACCEPTED BY BUILDING OWNERS IN ACCORDANCE WITH STO'S WARRANTY PROGRAMS WHICH ARE SUBJECT TO CHANGE FROM TIME TO TIME. For the fullest, most current information on proper application, clean-up, mixing and other specifications and warranties, cautions and disclaimers, please refer to the Sto Corp. website. [www.stocorp.com](http://www.stocorp.com)



# StoTherm® ci Fixture Attachment

Detail No.: 52s.73  
Date: June 2022

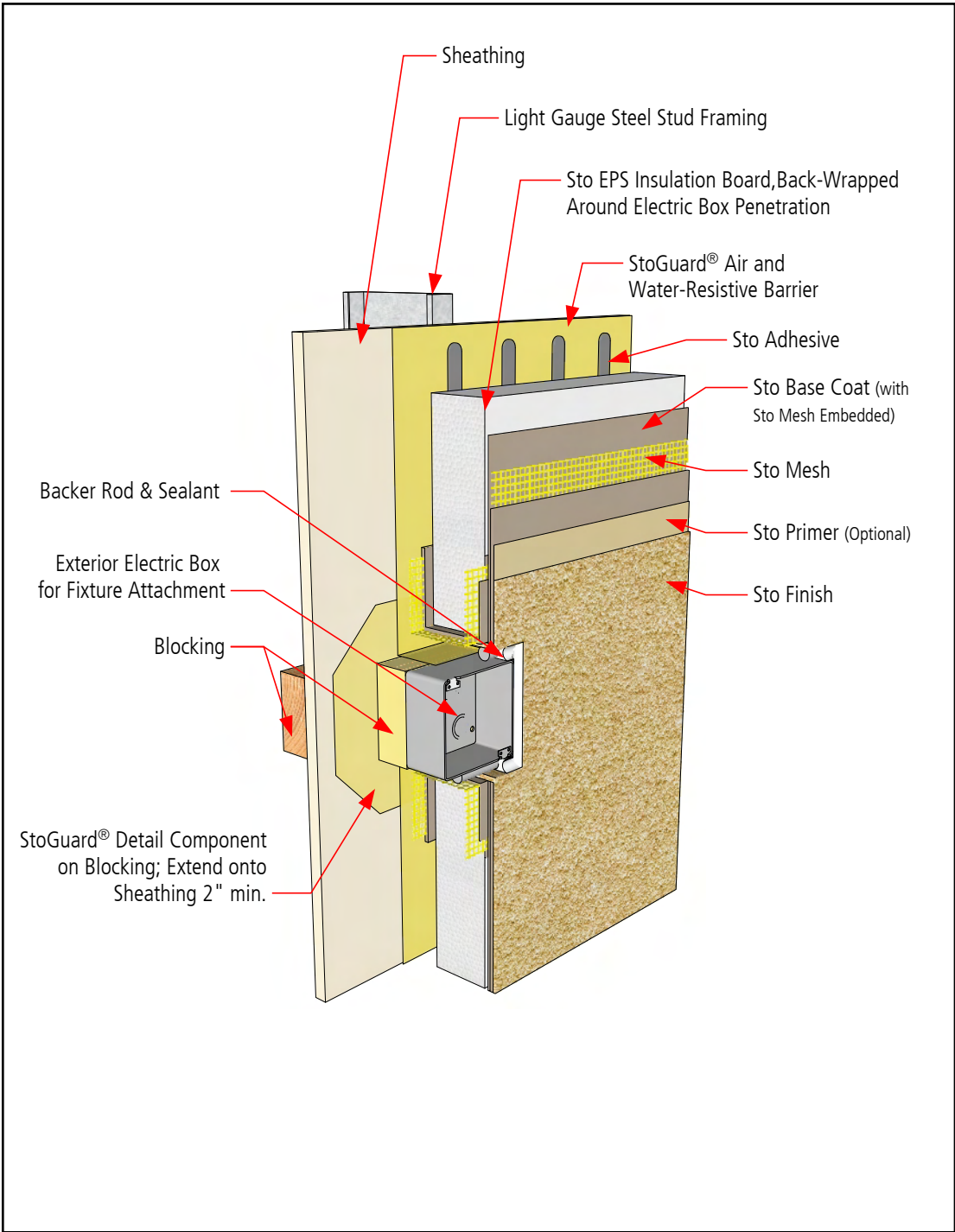

### Notes:

1. Refer to StoGuard Product Use Chart (Table 1.1) for StoGuard detail components; joint treatment, rough opening protection, backing for masonry anchors, or transitions to dissimilar materials, joints and seams in construction.
2. Refer to General Notes for specific information and design guidance on wall assembly components.
3. Components not identified as Sto are furnished by other manufacturers and are not necessarily installed by trades who install the Sto products. Refer to project specific contract documents.

### ATTENTION

Property of Sto Corp. All Rights Reserved

Sto products are intended for use by qualified professional contractors, not consumers, as a component of a larger construction assembly as specified by a qualified design professional, general contractor or builder. They should be installed in accordance with those specifications and Sto's instructions. Sto Corp. disclaims all, and assumes no, liability for on-site inspections, for its products applied improperly, or by unqualified persons or entities, or as part of an improperly designed or constructed building, for the nonperformance of adjacent building components or assemblies, or for other construction activities beyond Sto's control. Improper use of Sto products or use as part of an improperly designed or constructed larger assembly or building may result in serious damage to Sto products, and to the structure of the building or its components.

STO CORP. DISCLAIMS ALL WARRANTIES EXPRESSED OR IMPLIED EXCEPT FOR EXPLICIT LIMITED WRITTEN WARRANTIES ISSUED TO AND ACCEPTED BY BUILDING OWNERS IN ACCORDANCE WITH STO'S WARRANTY PROGRAMS WHICH ARE SUBJECT TO CHANGE FROM TIME TO TIME. For the fullest, most current information on proper application, clean-up, mixing and other specifications and warranties, cautions and disclaimers, please refer to the Sto Corp. website. [www.stocorp.com](http://www.stocorp.com)

[www.stocorp.com](http://www.stocorp.com)

